



**La classe de première S**  
**La tectonique des plaques:**  
**une approche historique**

**Laurent Jolivet**

**02 38 41 46 56**

**[laurent.jolivet@univ-orleans.fr](mailto:laurent.jolivet@univ-orleans.fr)**



Observatoire  
des sciences de  
l'univers en  
région Centre



# ***La classe de première S***

## **La tectonique des plaques: une approche historique**

Les grandes lignes de la tectonique des plaques ont été présentées au collège. Il s'agit, **en s'appuyant sur une démarche historique, de comprendre comment ce modèle a peu à peu été construit au cours de l'histoire des sciences et de le compléter.** On se limite à quelques étapes significatives de l'histoire de ce modèle.

L'exemple de la tectonique des plaques fournit l'occasion de **comprendre la notion de modèle scientifique et son mode d'élaboration.** Il s'agit d'une construction intellectuelle hypothétique et modifiable. Au cours du temps, la communauté scientifique l'affine et le précise en le confrontant en permanence au réel. Il a une valeur prédictive et c'est souvent l'une de ces prédictions qui conduit à la recherche d'un fait nouveau qui, suivant qu'il est ou non découvert, conduit à étayer ou modifier le modèle. La solidité du modèle est peu à peu acquise par l'accumulation d'observations en accord avec lui. Les progrès techniques accompagnent le perfectionnement du modèle tout autant que les débats et controverses.

## La naissance de l'idée

Au début du XX<sup>e</sup> les premières intuitions évoquant la mobilité horizontale s'appuient sur quelques constatations :

- la distribution bimodale des altitudes (continents/océans),
- les tracés des côtes,
- la distribution géographique des paléoclimats et de certains fossiles.

Ces idées se heurtent au constat d'un état solide de la quasi-totalité du globe terrestre établi, à la même époque, par les études sismiques. Elle est rejetée par une part importante de la communauté scientifique.



**Osmond Fisher (1817-1914) géologue britannique, *tenant d'un modèle de Terre en refroidissement*, note les similitudes de la forme des continents et propose qu'ils aient été autrefois réunis.**

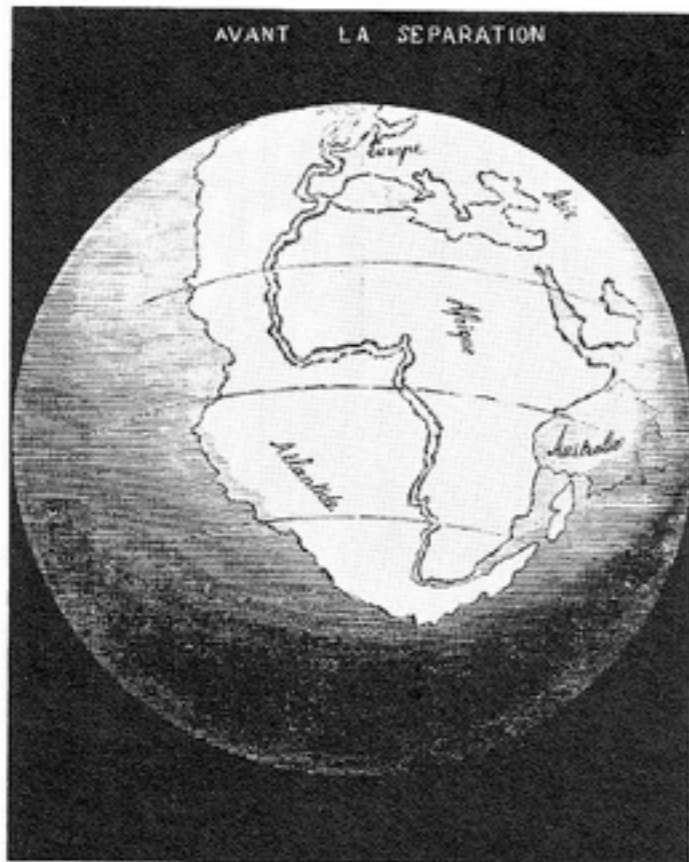

**Antonio Snider-Pellegrini, géographe français (1802-1885) propose une première reconstitution de la Pangée avant le modèle d'Alfred Wegener. Il avait trouvé des plantes fossiles datant du Carbonifère identiques de part et d'autre de l'Atlantique. *Il pensait que le déluge biblique était la cause de la séparation des continents.***





Eduard Suess (1831-1914)

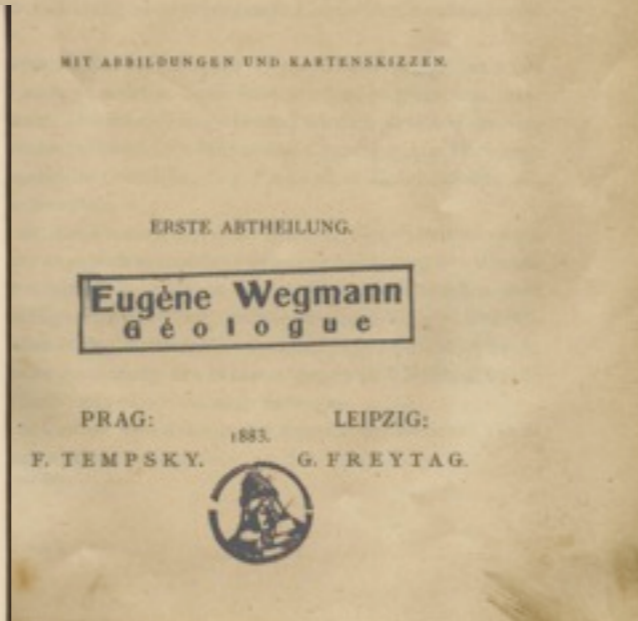
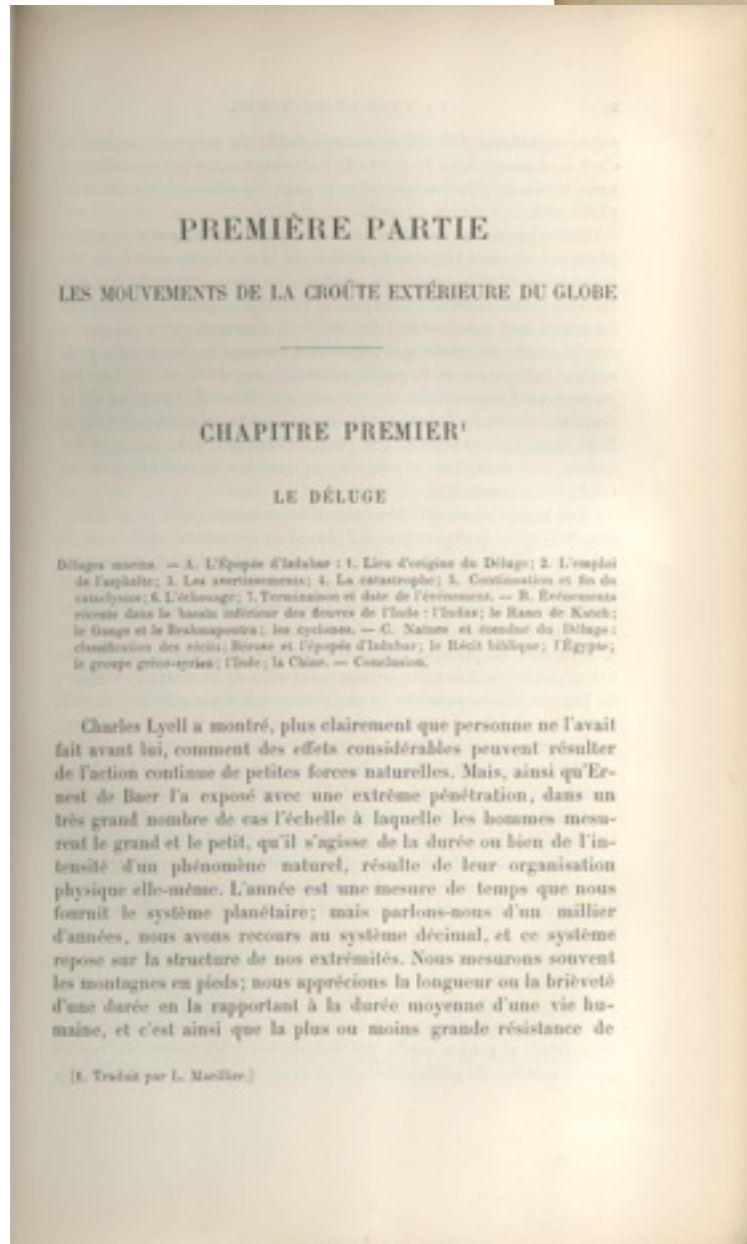
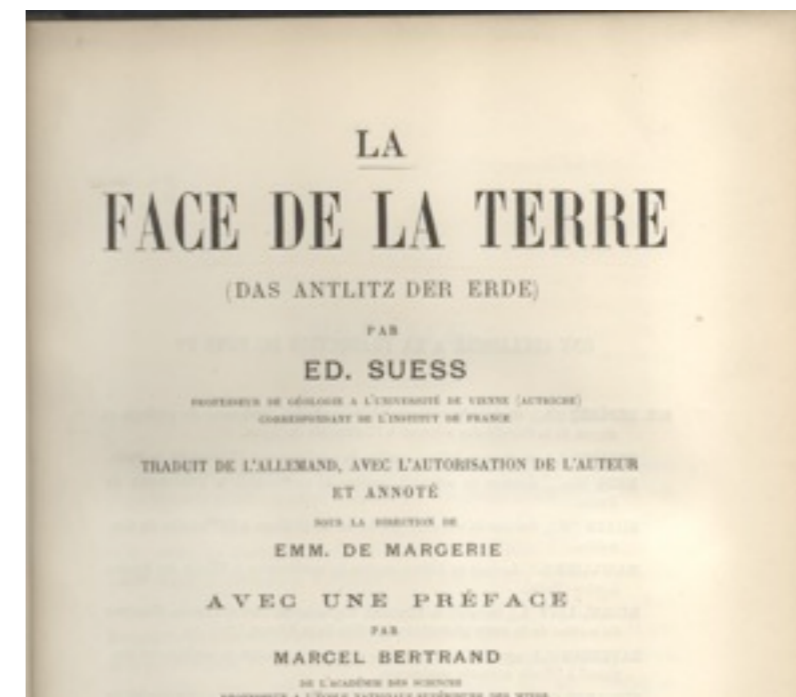
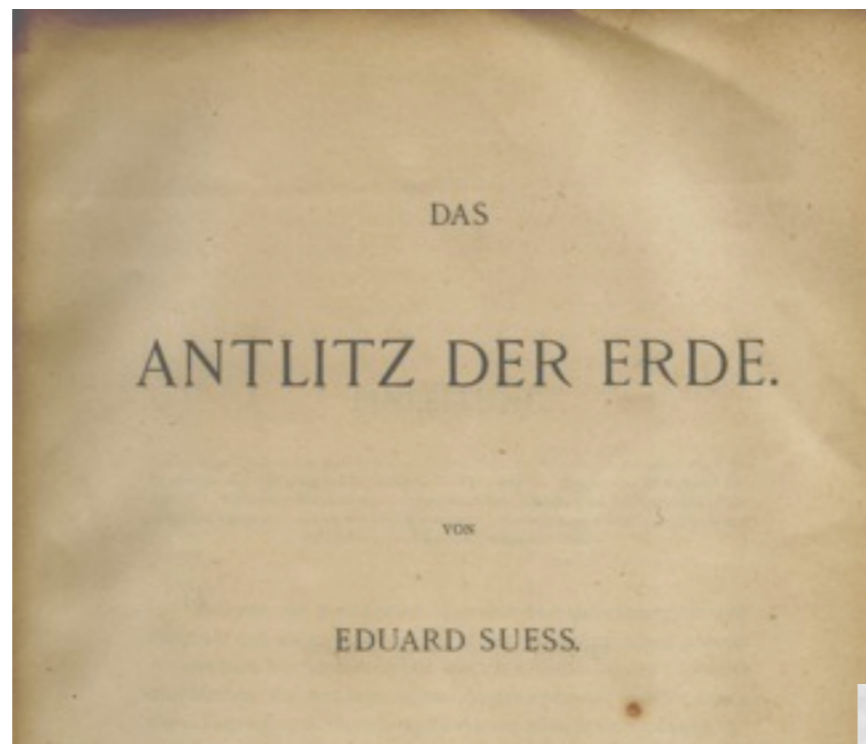

Ce schéma est très moderne bien qu'E. Suess ait été un partisan de la contraction de la Terre

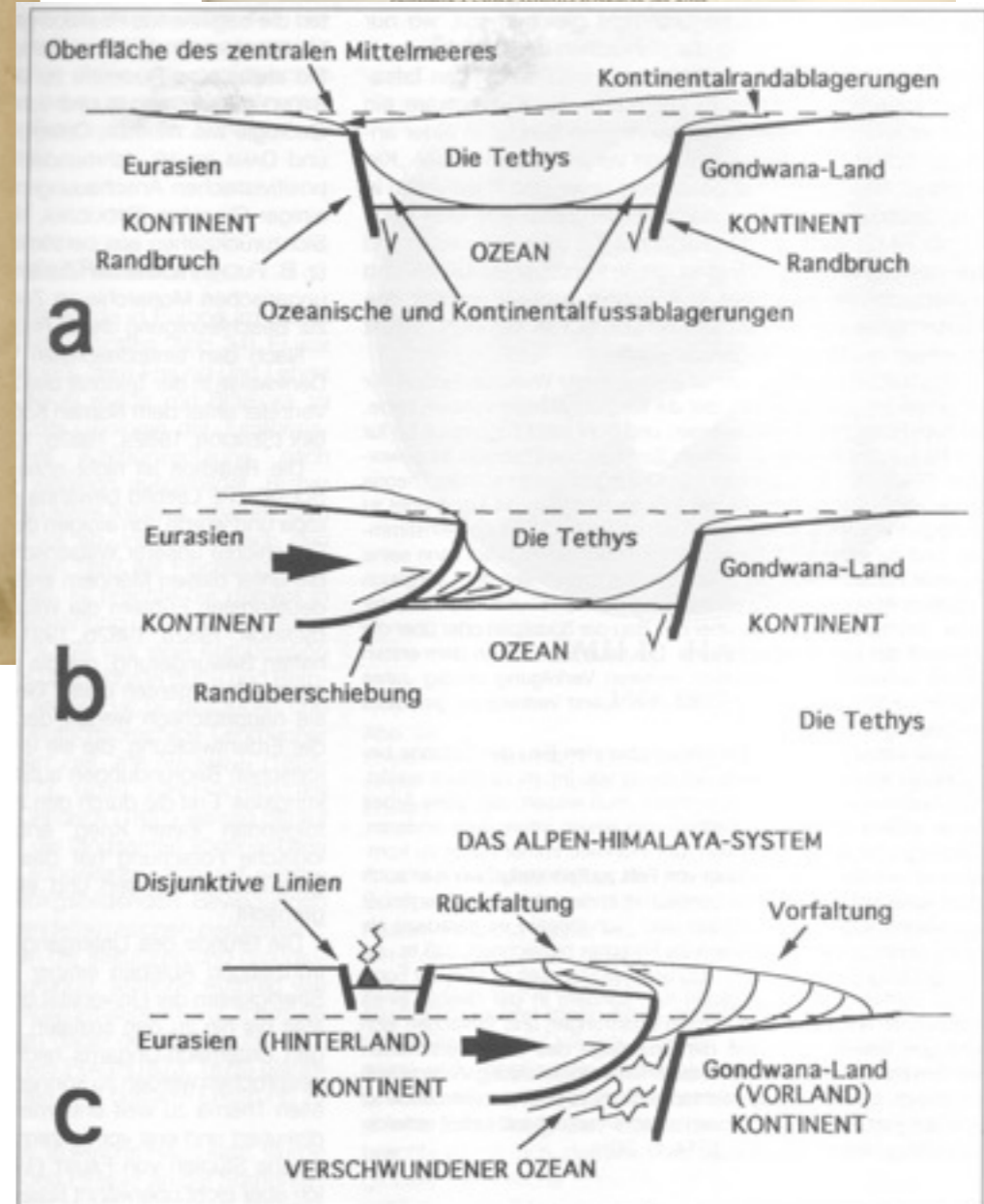

(repris du cours de A.M.C. Sengör au Collège de France en 2005)



Les géologues ne sont pas fixistes et la découverte des nappes de charriage (1884) est une grande avancée conceptuelle



Bertrand, 1884

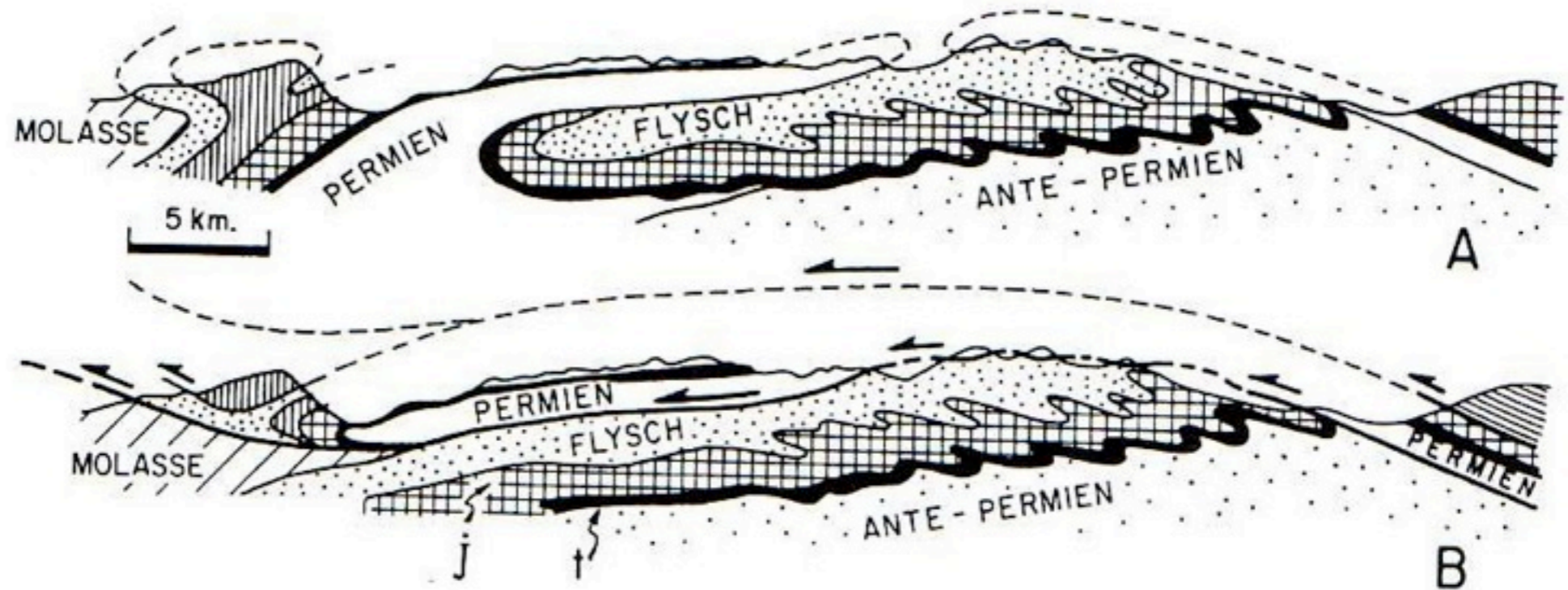

Fig. 11 - La structure des Alpes de Glaris (d'après Bailey 1935, modifié). a) l'hypothèse du double pli de Heim. b) l'hypothèse d'un charriage unique vers le nord de Bertrand.

Peach & Horne, 1884



Fig. 12 - Le charriage du Moine en Ecosse (d'après Peach et Horne 1884, modifié).

(Figures reprises du livre d'Olivier Merle - Masson, 1994)



## LES NAPPES DES ALPES ORIENTALES ET LA SYNTHÈSE DES ALPES

par M. Pierre TERMIER.

(PLANCHES XXII et XXIII).

### AVANT-PROPOS

Ceux d'entre mes confrères qui ont eu, comme moi, la bonne fortune d'entendre M. Maurice Lugeon, le jour où il a présenté à la Société géologique de France sa brillante synthèse des Alpes suisses, se sont demandé, sans doute, comme je me le suis à moi-même demandé, de quelle manière et dans quelle mesure cette conception grandiose allait s'étendre aux Alpes orientales. Du côté de l'occident, aucune objection de principe n'était à craindre. Nous savions tous, et depuis quelques années déjà, que les *charriages* ont joué un grand rôle dans le façonnement des Alpes françaises; et nous ne discutons guère que sur l'ampleur qu'il convenait d'attribuer à ces charriages, ou encore sur les mouvements relatifs des diverses zones, ou enfin sur l'origine de tel ou tel lambeau charrié. Et, en effet, lorsque, quelques mois après la communication de M. Lugeon, j'ai proposé, ici même, une synthèse des Alpes franco-italiennes fondée sur le cheminement, par-dessus toutes les montagnes que nous voyons aujourd'hui, d'un lourd paquet de terrains d'origine piémontaise, je n'ai pas été trop vivement combattu. Mais que viendrait-il de l'orient, pour la nouvelle théorie : démenti formel, ou confirmation éclatante ? J'avoue que, depuis ce moment, aucune question ne m'a paru présenter, ni un intérêt aussi vif, ni une semblable « actualité ».

C'est pour essayer, non pas de résoudre le problème — j'étais loin de m'attendre à ce que la solution en fût aussi aisée —, mais de me faire une opinion personnelle sur la structure des Alpes orientales, que j'ai voulu suivre, après le Congrès géologique international de Vienne, l'excursion que M. le Professeur F. Becke devait diriger dans les montagnes du Zillertal, par le travers de la région occidentale des Hohe Tauern. Cette excursion, admirablement conduite, et favorisée par un temps absolument pur, a

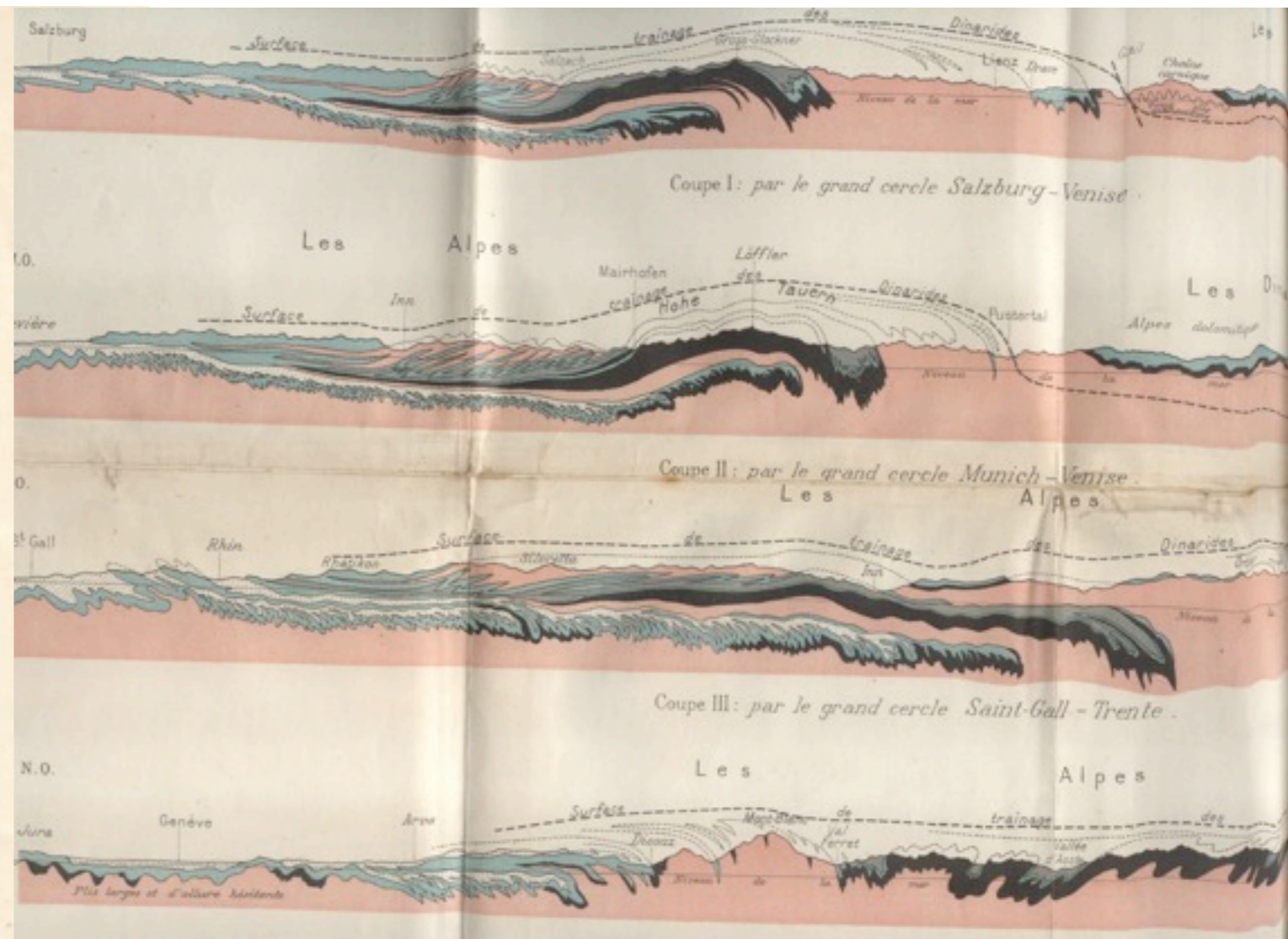

La réinterprétation de la tectonique des Alpes orientales par Pierre Termier en 1903

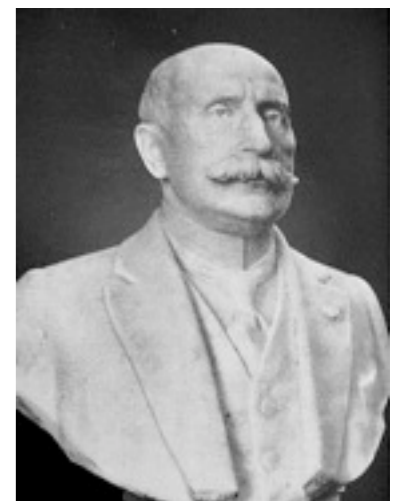



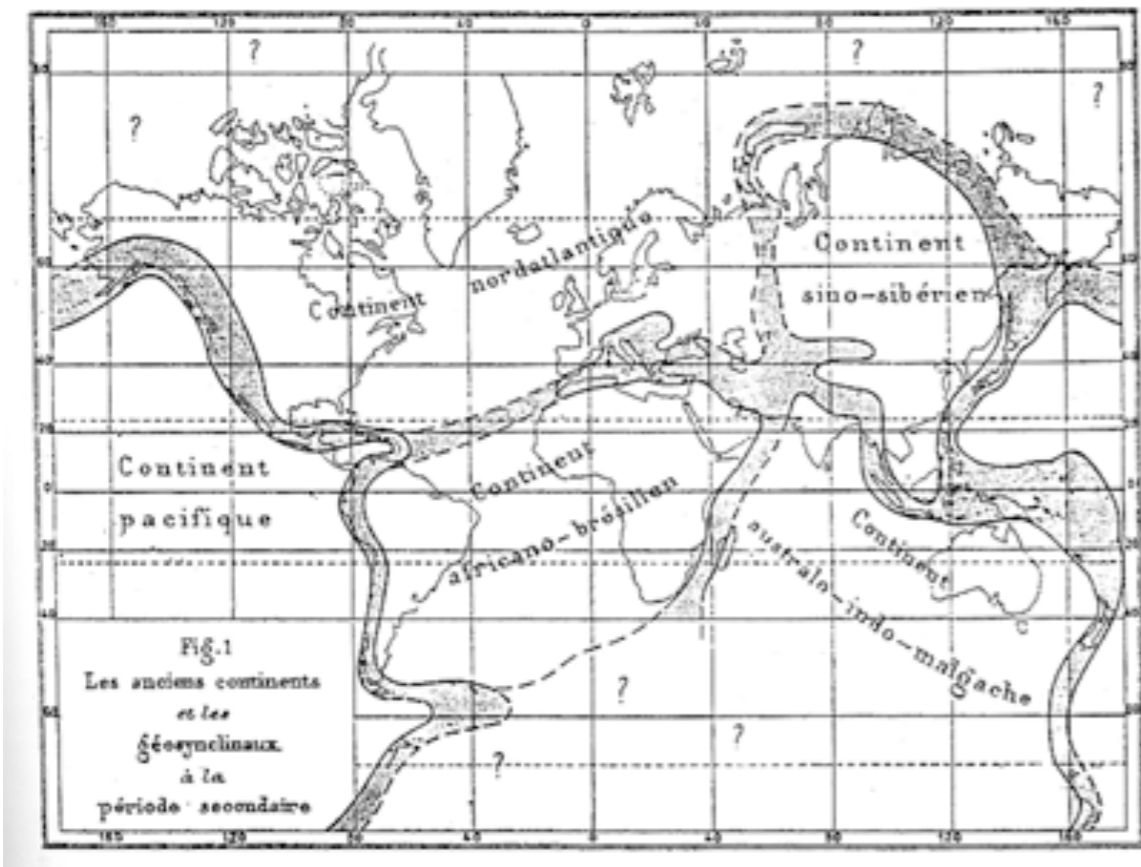

Carte des aires continentales par Emile Haug (1900).

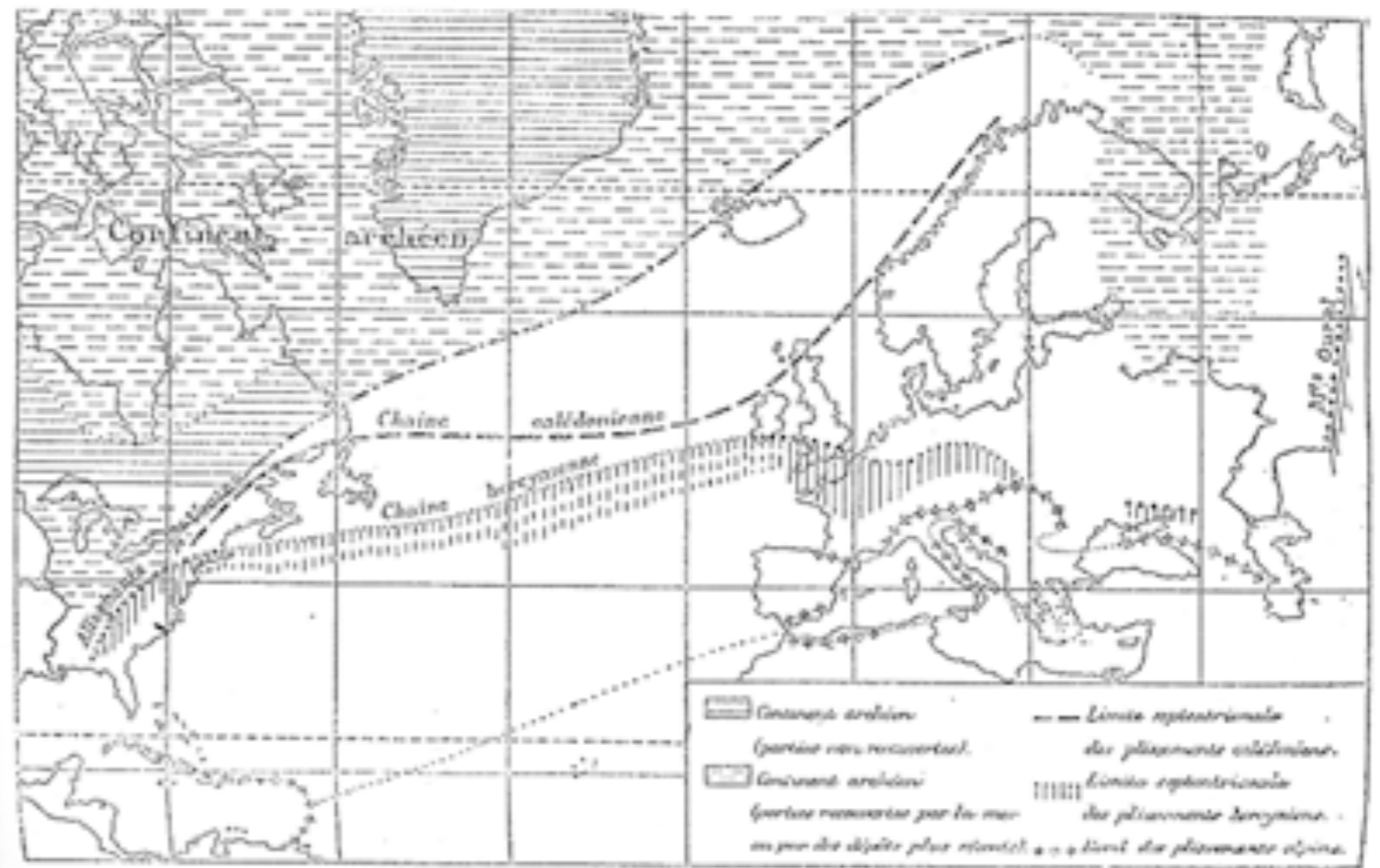

Prolongement des chaînes européennes sur le continent nord-américain selon Marcel Bertrand (1887).

Les géologues pensent «global» mais ils manquent des concepts explicatifs (c'est l'époque du «géosynclinal»)

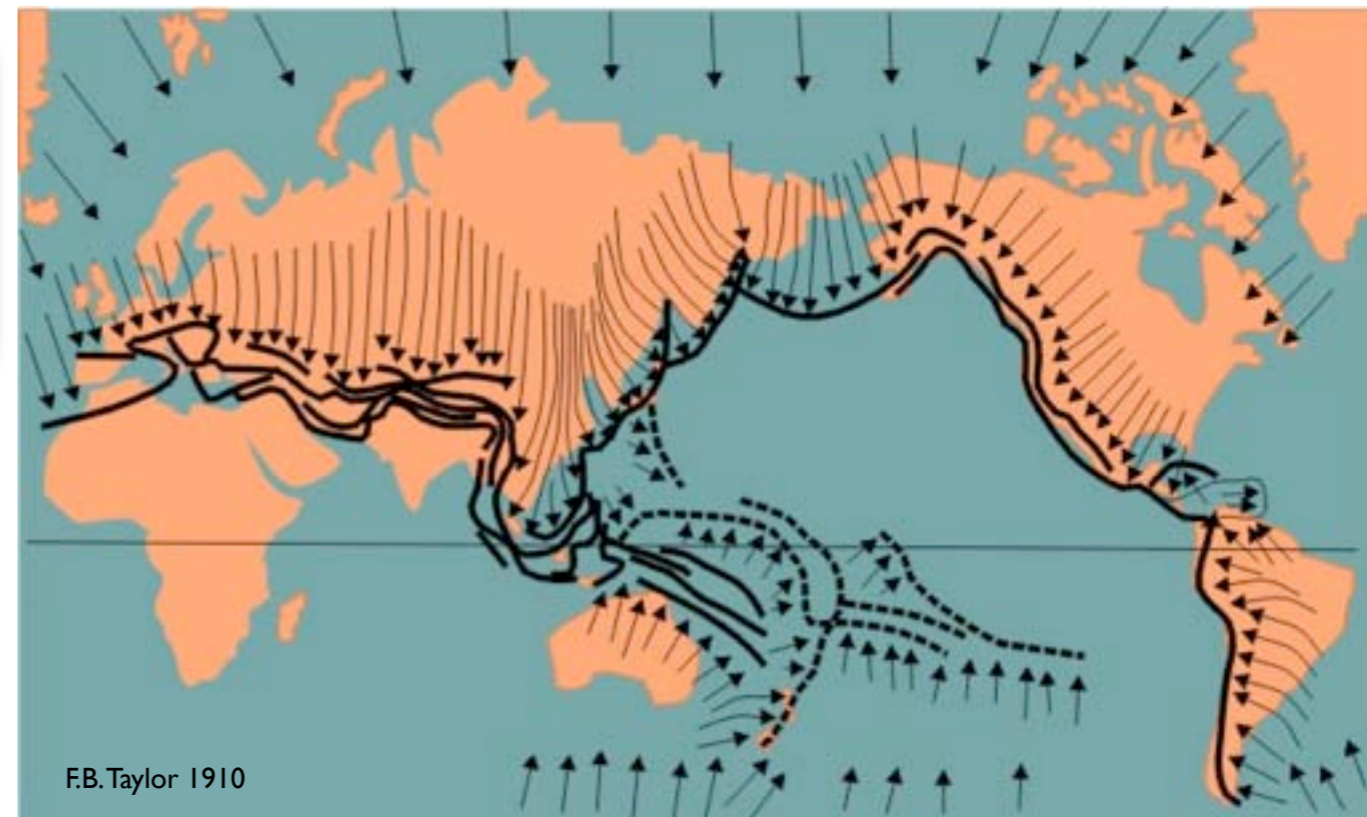

[http://www2.ulg.ac.be/geolsed/geol\\_gen/geol\\_gen.htm](http://www2.ulg.ac.be/geolsed/geol_gen/geol_gen.htm)

[planet-terre.ens-lyon.fr/planetterre/XML/db/p...](http://planet-terre.ens-lyon.fr/planetterre/XML/db/p...)



Abb. 4.

Jung-Karbon

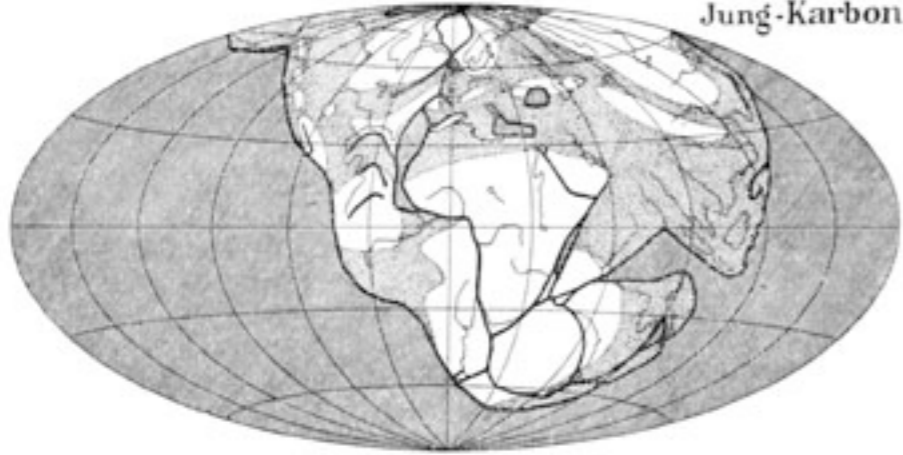

Eozän

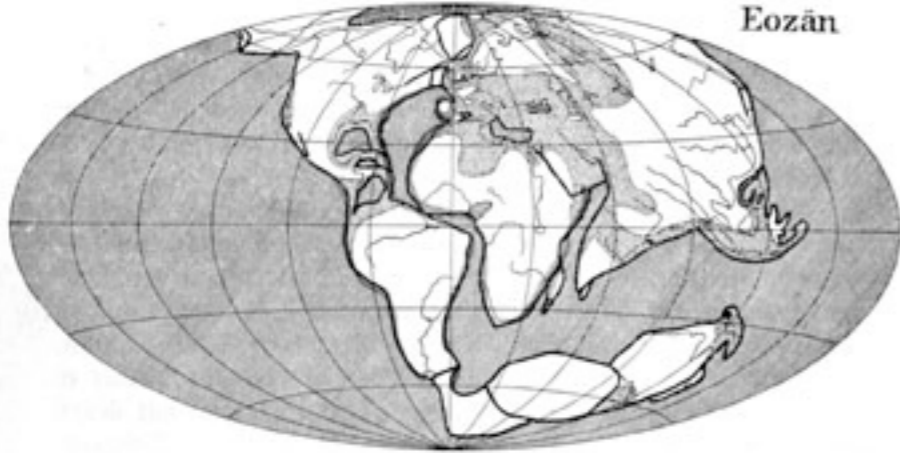

Alt-Quartär



Rekonstruktionen der Erdkarte nach der Verschiebungstheorie für drei Zeiten.

Schraffiert: Tiefsee; punktiert: Flachsee; heutige Konturen und Flüsse nur zum Erkennen. Gradnetz willkürlich (das heutige von Afrika).



Wegener utilise la distribution bimodale des altitudes pour argumenter la dichotomie continents-océans... Il parle de continents qui flottent sur un substratum visqueux. Il évoque aussi le problème des vitesses de déformation (la poix se casse mais elle flue quand on la laisse reposer..)



**Alfred Wegener: Die Entstehung der Kontinente (1912, 1915)**

**Die Entstehung der Kontinente und Ozeane (1915, 1929)**

## Position actuelle des continents

[www.lhce.lu/Geologie/Option/derive.html](http://www.lhce.lu/Geologie/Option/derive.html)



## La Pangée de Wegener

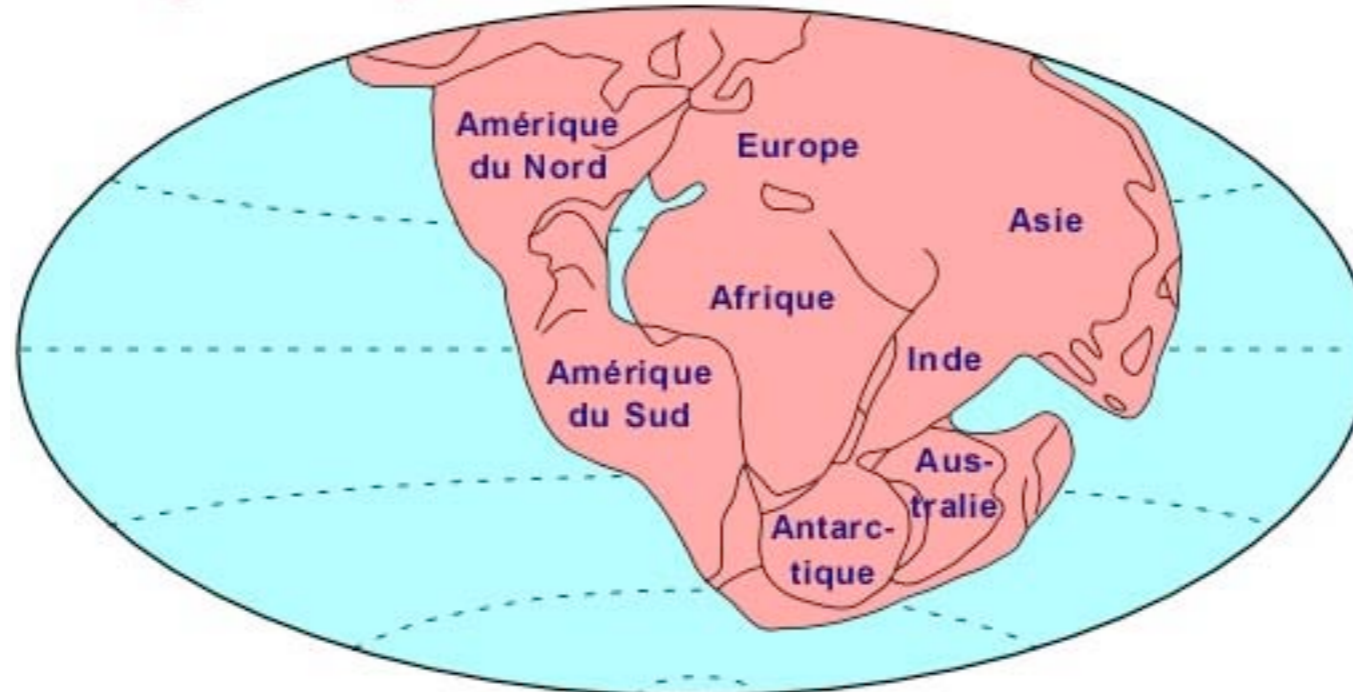



- **Cynognathus**: reptile prédateur terrestre ayant vécu il y a 240 Ma
- ◆ **Mesosaurus**: petit reptile de lacs d'eau douce, il y a 260 Ma
- **Lystrosaurus**: reptile terrestre ayant vécu il y a 240 Ma
- ♣ **Glossopteris**: plante terrestre d'il y a 240 Ma

[www.lhce.lu/Geologie/Option/derive.html](http://www.lhce.lu/Geologie/Option/derive.html)

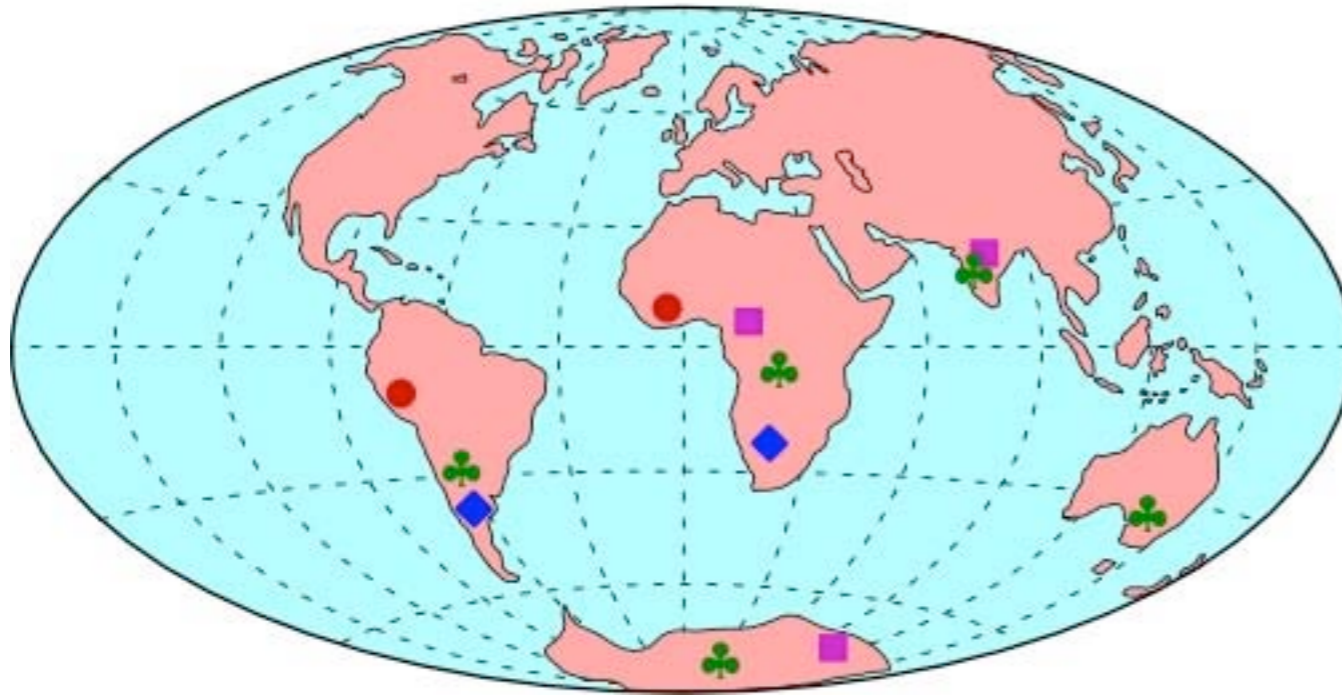

### La solution de Wegener

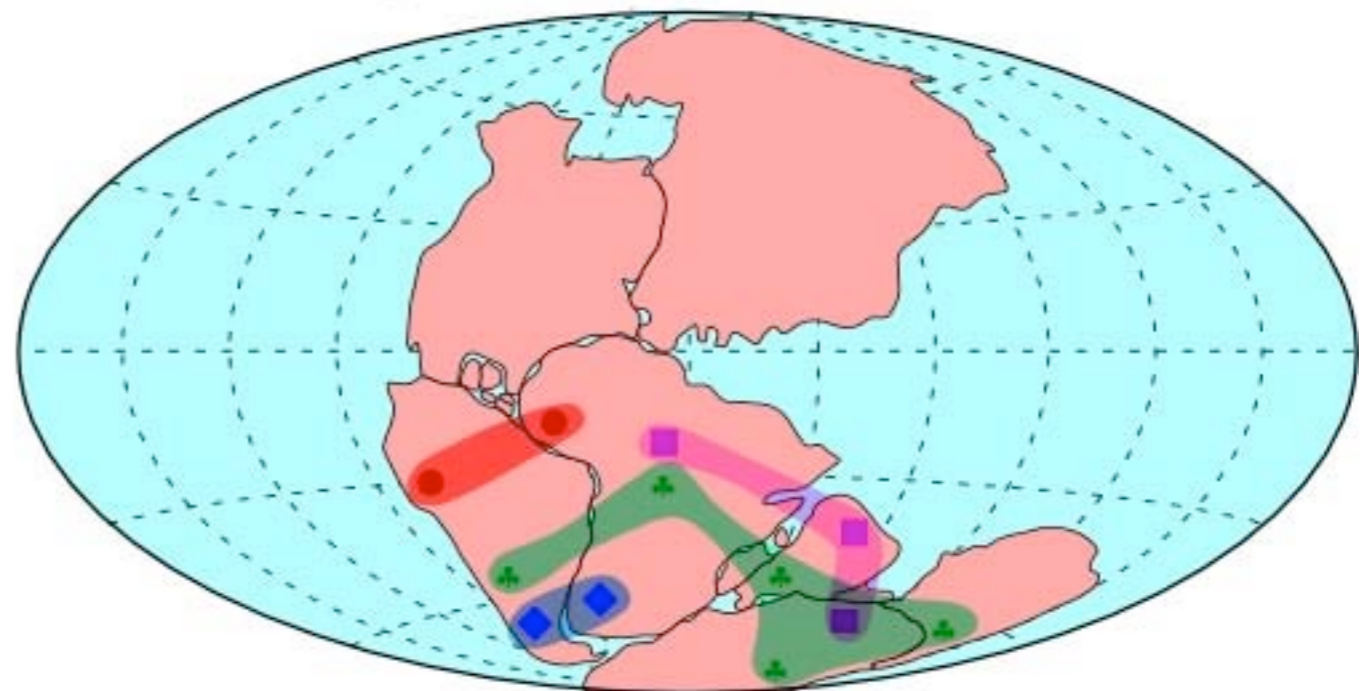

→ sens d'écoulement de la glace

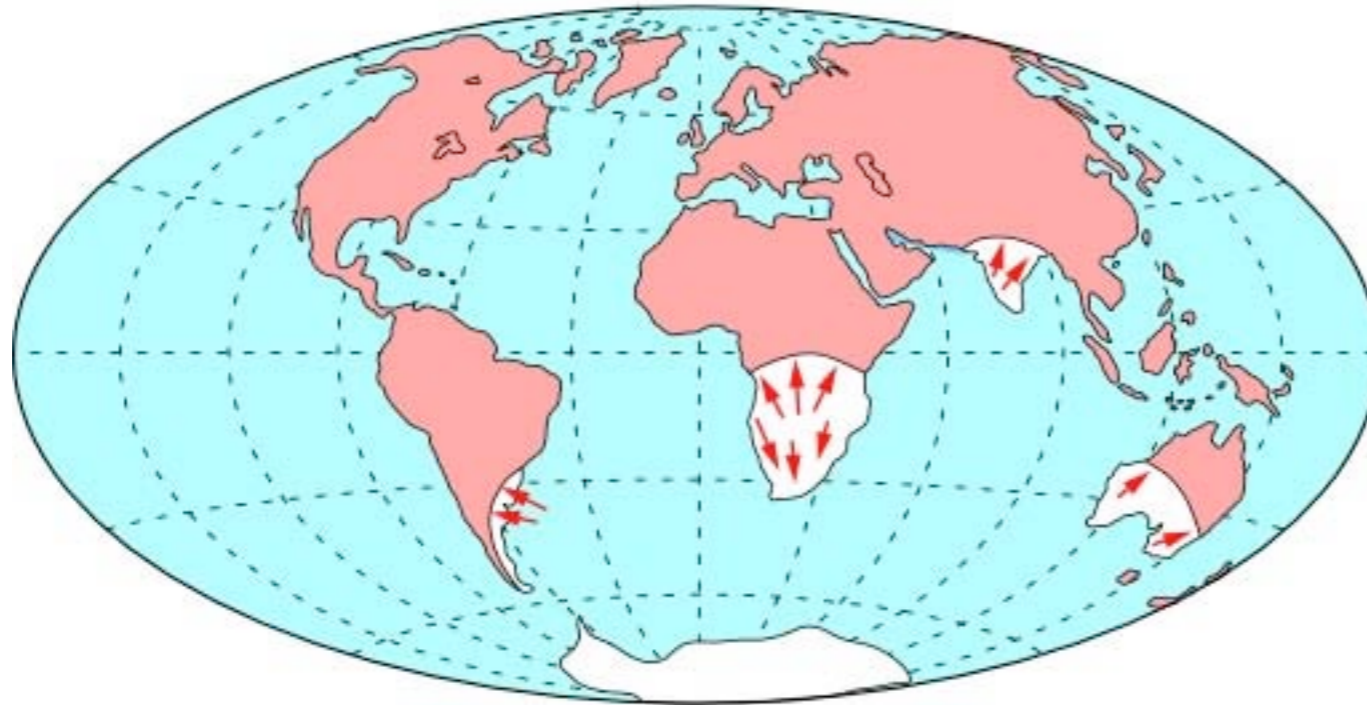

**La solution de Wegener**

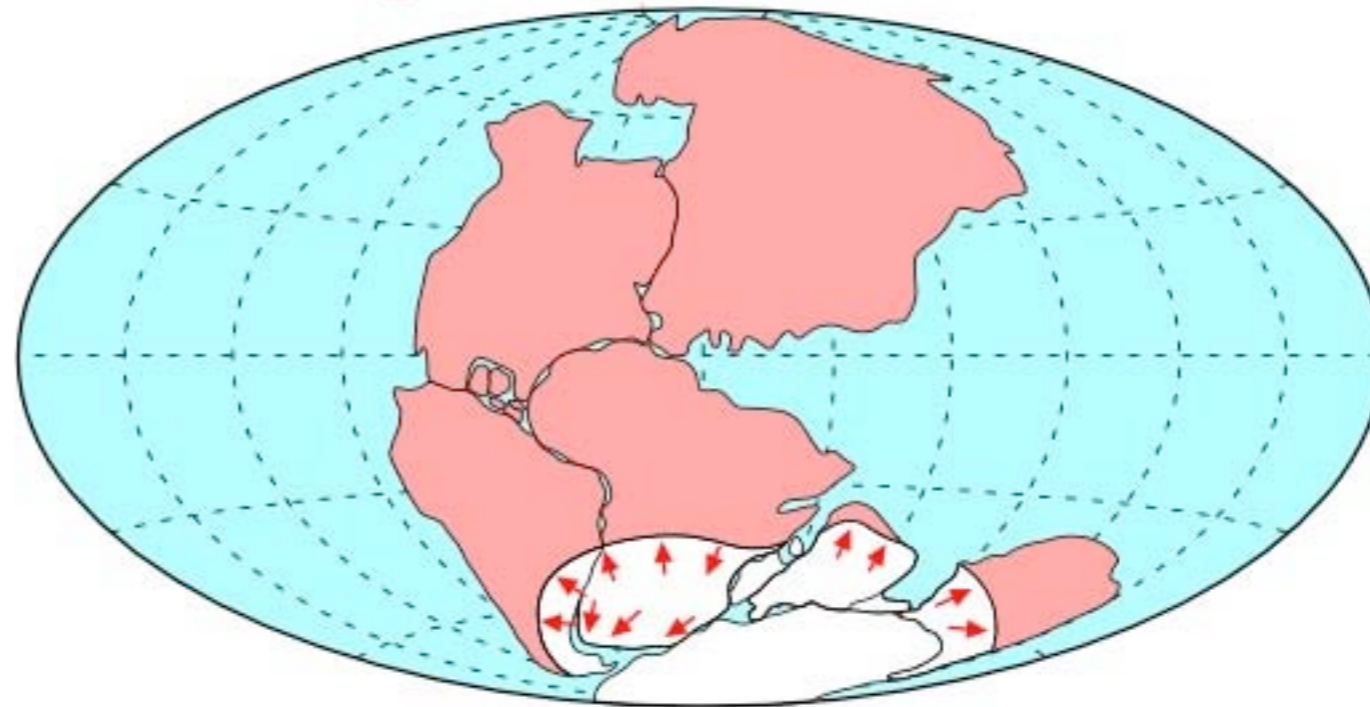



# Certains géologues sont très tôt «mobilistes»

La continuité des structures géologiques d'un continent à l'autre selon Alexandre Du Toit (1927).



La formation des montagnes par la collision de deux continents selon Emile Argand (1924). Ses visions sont prophétiques.

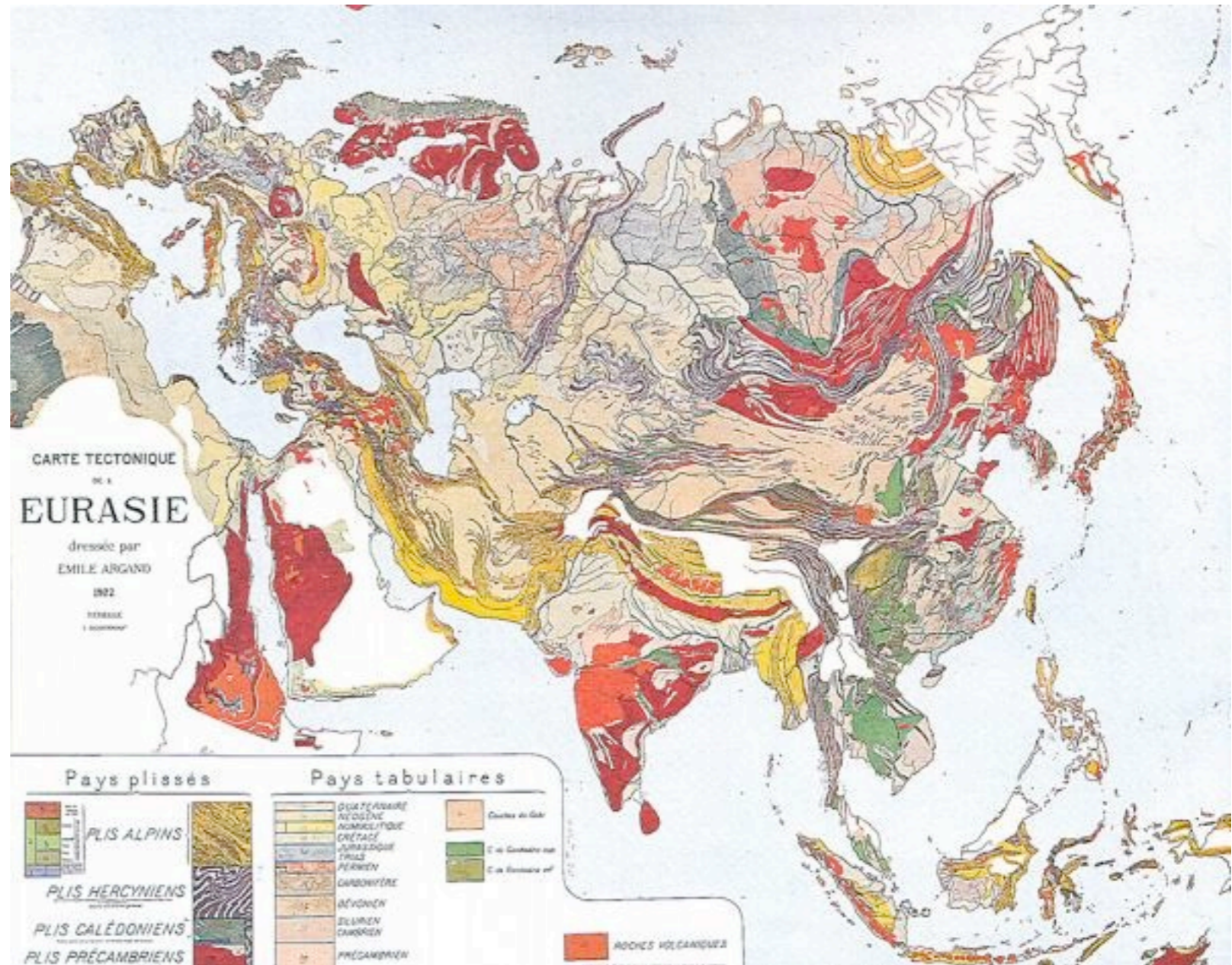



# Certains géologues sont très tôt «mobilistes»

La continuité des structures géologiques d'un continent à l'autre selon Alexandre Du Toit (1927).



La formation des montagnes par la collision de deux continents selon Emile Argand (1924). Ses visions sont prophétiques.

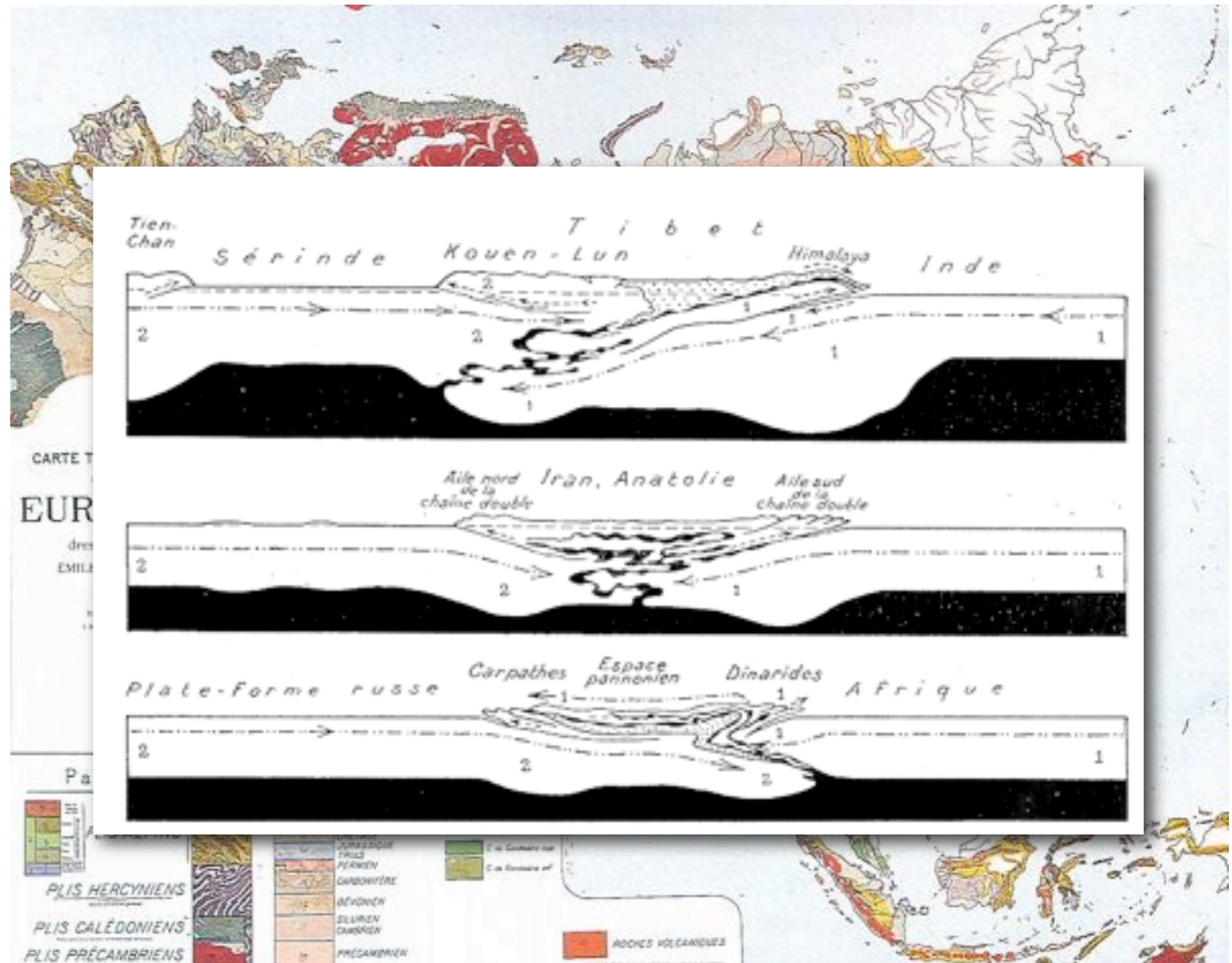



# Certains géologues sont très tôt «mobilistes»

La continuité des structures géologiques d'un continent à l'autre selon Alexandre Du Toit (1927).

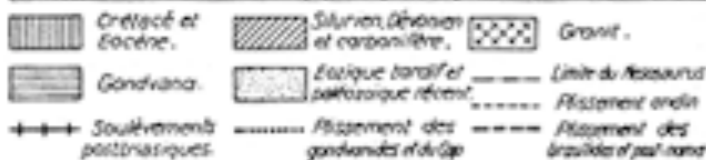

La formation des montagnes par la collision de deux continents selon Emile Argand (1924). Ses visions sont prophétiques.

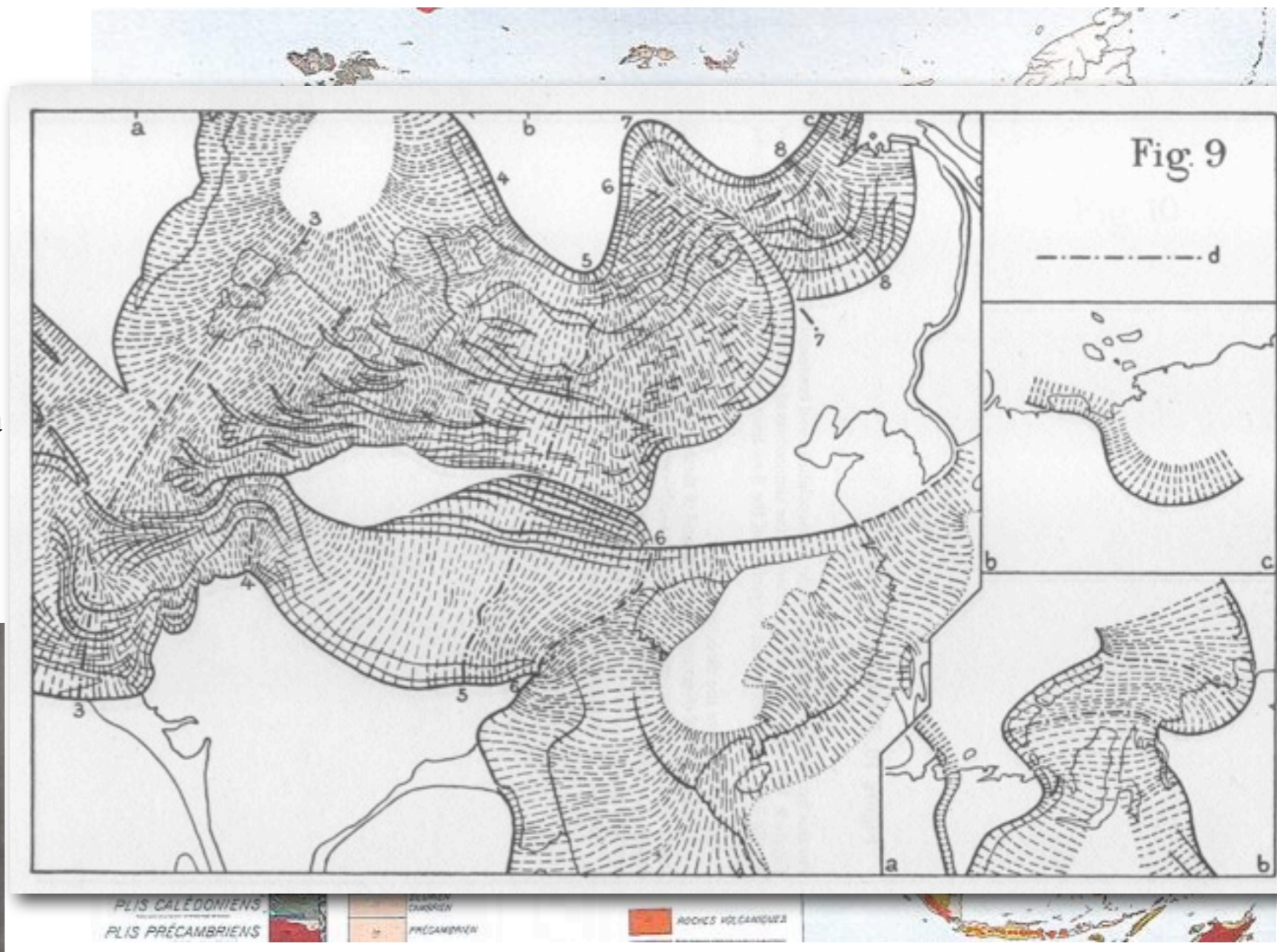



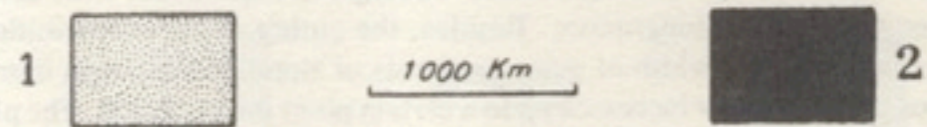
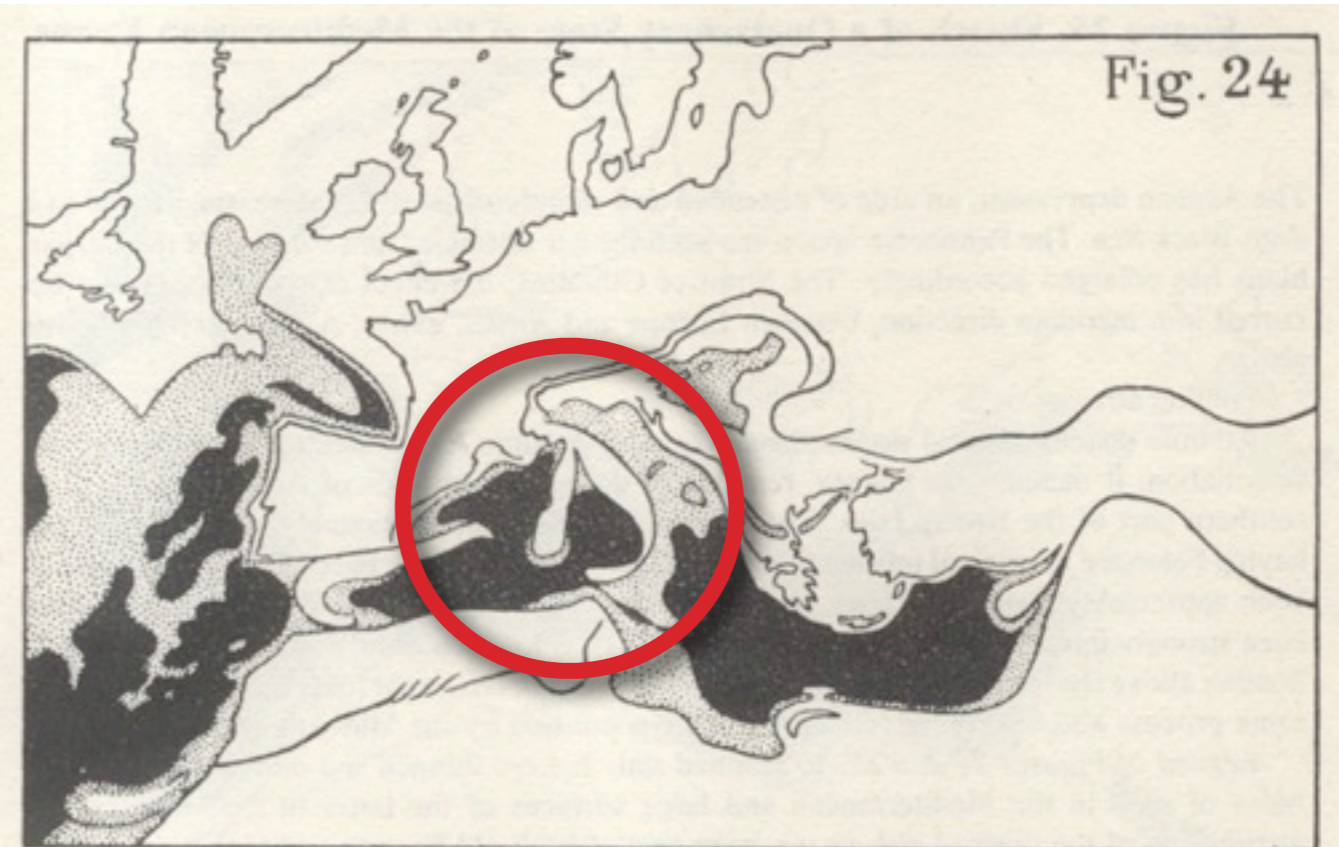
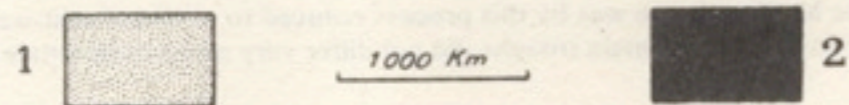
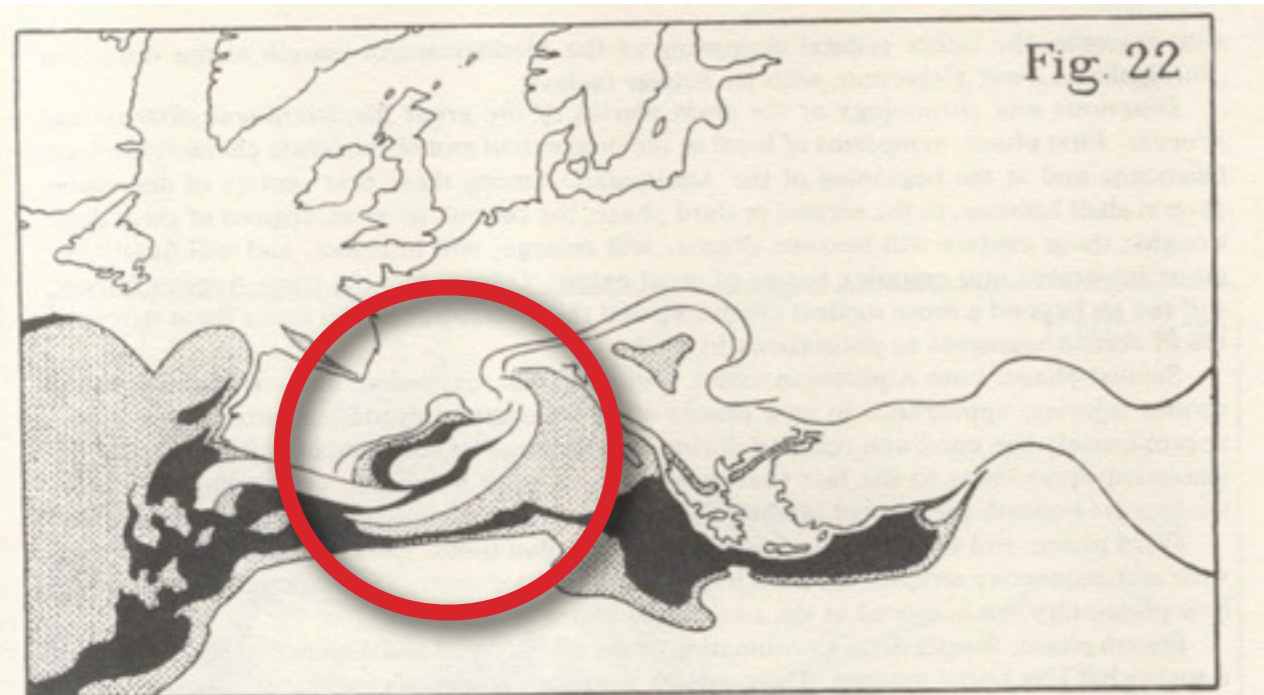

**L'évolution de la Méditerranée selon Emile Argand (1924) !**



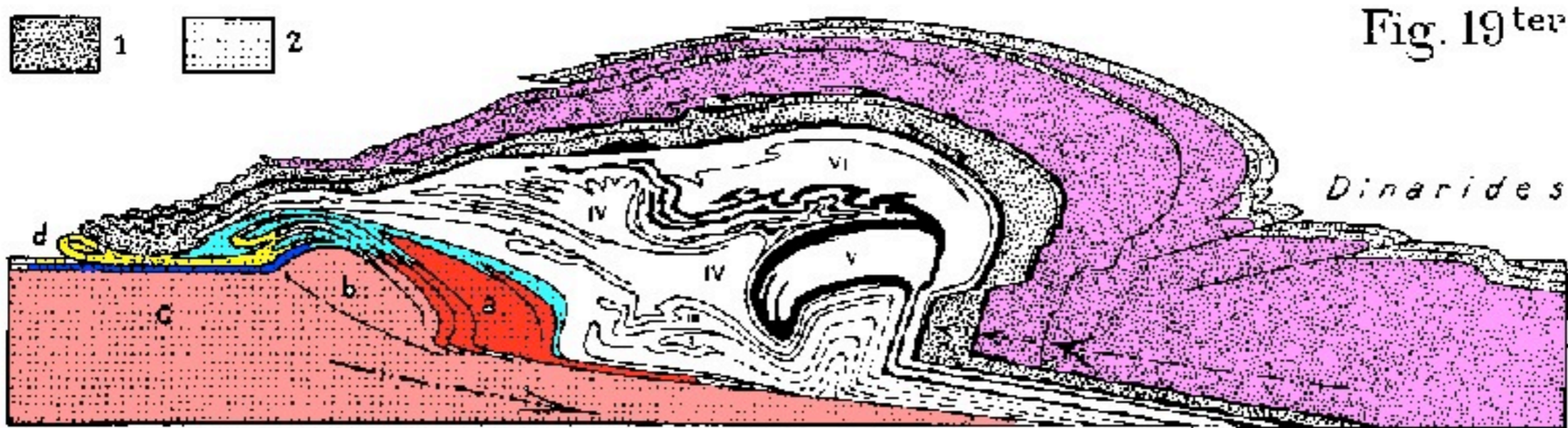

Fig. 19<sup>ter</sup>

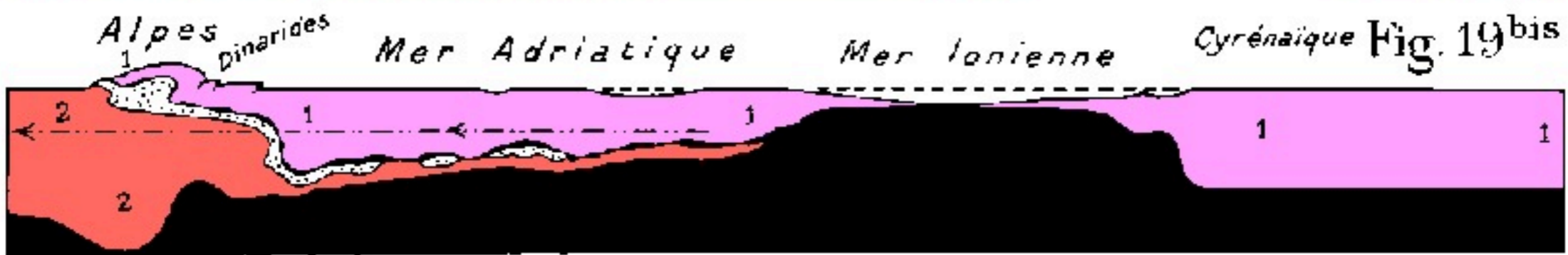

Fig. 19<sup>bis</sup>



Fig. 19

EMILE ARGAND

353

Les Alpes résultant de la collision de deux masses continentales  
 Extension et océanisation en Méditerranée (Emile Argand)

## Mais la théorie de Wegener est très largement rejetée



Harold Jeffreys (1891-1989)

### Le rejet de la théorie de Wegener

Ce n'est qu'en 1922 que les géologues commencent à s'intéresser aux thèses de Wegener. Passée la réserve du début, les hostilités deviennent de plus en plus virulentes. Les détracteurs doutent du sérieux scientifique de Wegener et pour justifier leur rejet ils argumentent que les mesures géodésiques de l'éloignement du Groenland sont plus qu'incertaines, que les ajustements entre continents sont imprécis et sans doute accidentels, que les ressemblances géologiques et paléontologiques ne sont pas si évidentes et qu'il est bien téméraire de vouloir prouver l'existence d'un ancien continent unique en cherchant à raccorder les moraines glaciaires...

**Lake**, en 1922, ouvre les hostilité contre la théorie Wegener, en mettant en doute le sérieux de sa démarche scientifique :

« Wegener lui-même n'aide pas son lecteur à se faire un jugement impartial. Même si son attitude a pu être originale, dans son livre, il ne cherche pas la vérité, il défend une cause, et il ferme les yeux devant chaque fait et chaque argument qui la contredit » (in U. Marxin, *Continental drift : Evolution of a concept*, Washington, Smithsonian Institution Press, 1973, p. 83.)

Et que se passe-t-il sur le fond des océans et avant les 200 derniers millions d'années ? Wegener n'en dit rien et ces deux lacunes ont certainement joué un grand rôle dans le rejet de sa théorie.

Mais les détracteurs trouvent leurs objections les plus fortes dans le mécanisme invoqué pour rendre compte des mouvements : l'intensité des forces supposées est bien trop faible, la résistance du sima bien trop forte pour permettre un déplacement appréciable des continents.

Le chef de file des négateurs absolus est Harold Jeffreys (1891-1989). Il calcule que les forces supposées ont une amplitude  $2,5 \cdot 10^5$  fois trop faible pour mouvoir et déformer les blocs continentaux et pour lui la théorie des translations est « out of the question ».



In Holmes, 1929

Sir Arthur Holmes (1890-1965) est certainement le plus visionnaire des géologues mobilistes. Il a pressenti de nombreux concepts en vogue aujourd'hui

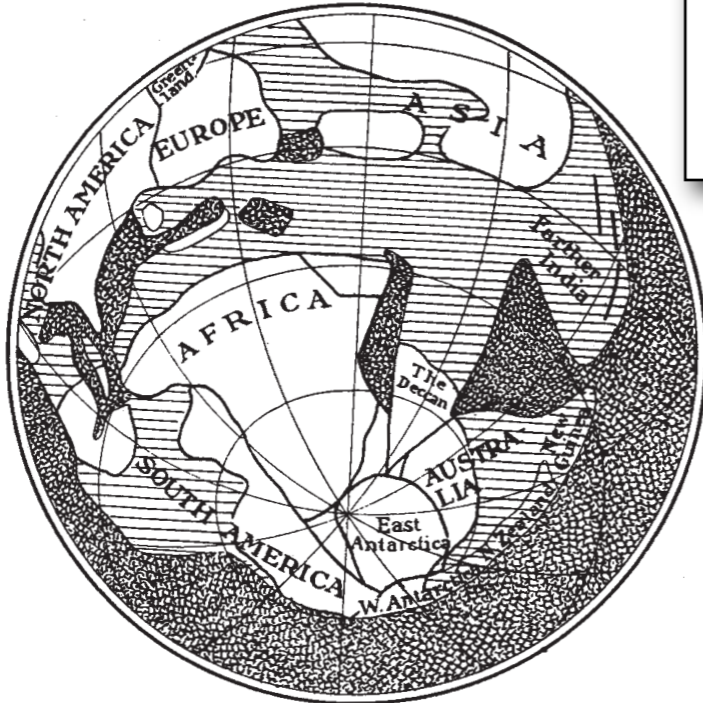
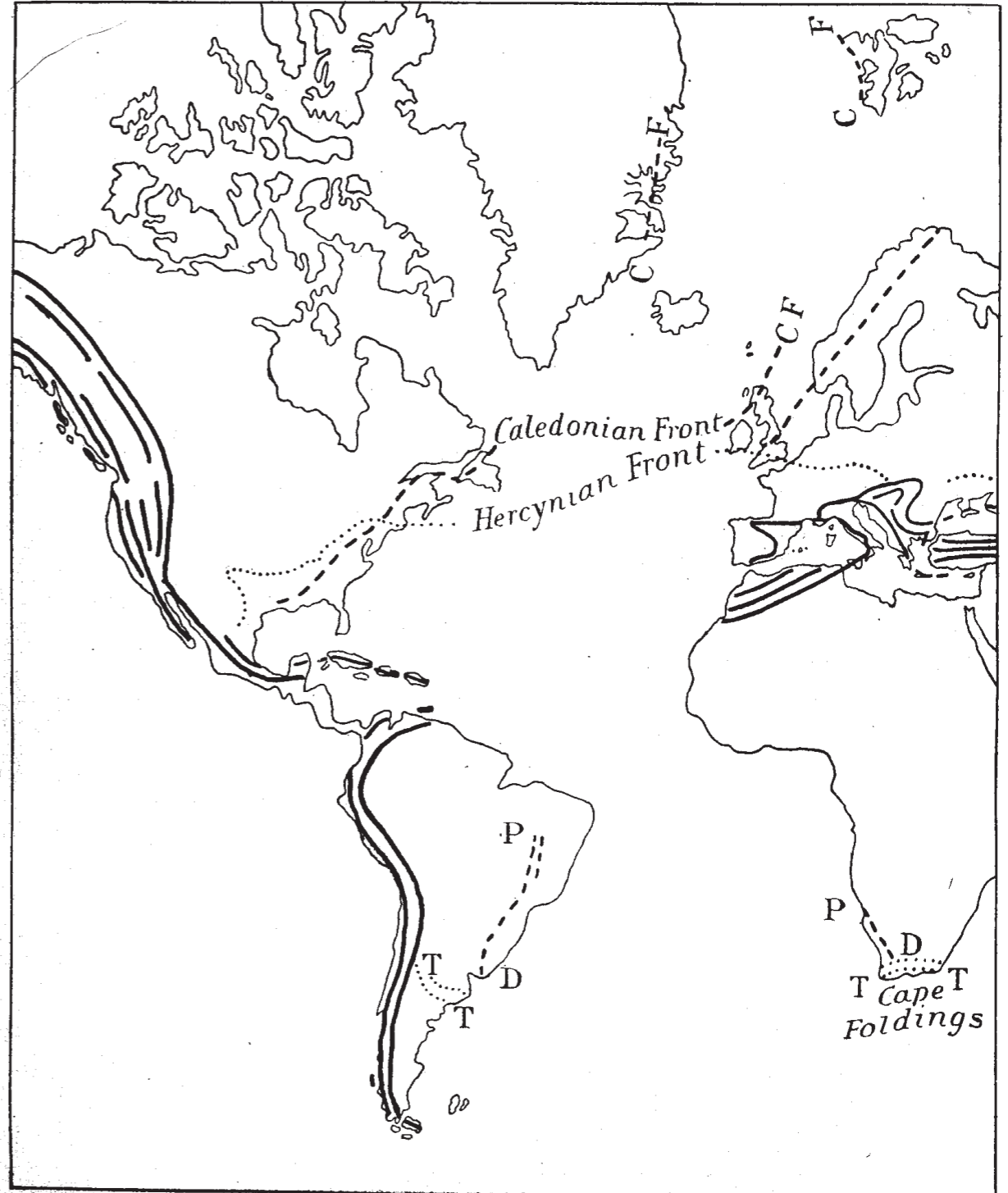

FIG. 1.—WEGENER'S CONCEPTION OF THE WORLD IN THE CARBONIFEROUS PERIOD. Heavily shaded portions indicate deep seas ; horizontal lines shallow water ; unshaded portions dry land. Reproduced from DISCOVERY, May, 1922, by courtesy of Messrs. Benn Bros., Ltd.



Sir Arthur Holmes (1890-1965), the British geologist who contributed to our understanding of Earth's age. Photo courtesy of University of Edinburgh, Department of Geology and Geophysics



Chaleur de la Terre,  
convection et  
mouvements en surface,  
chaînes de montagnes...

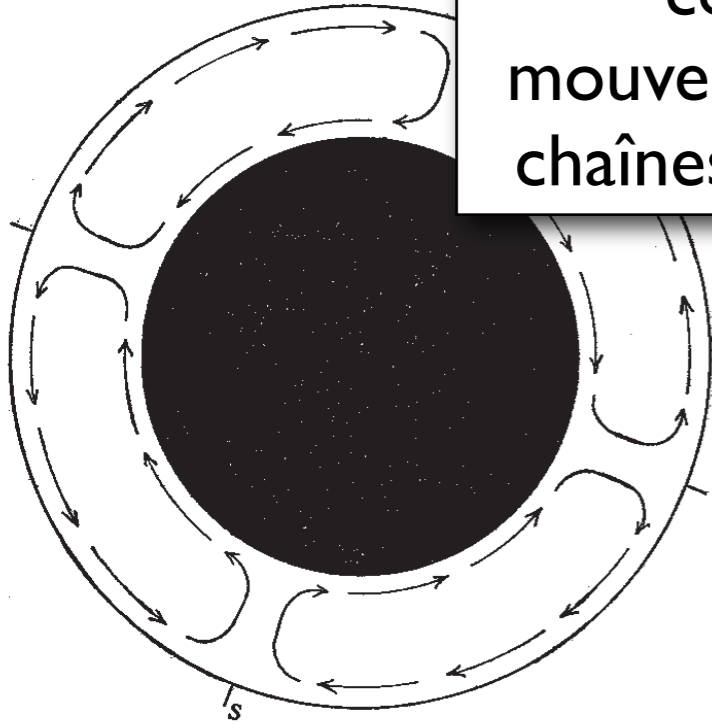

Fig. 1.1

THE SUB-CONTINENTAL CIRCULATION.

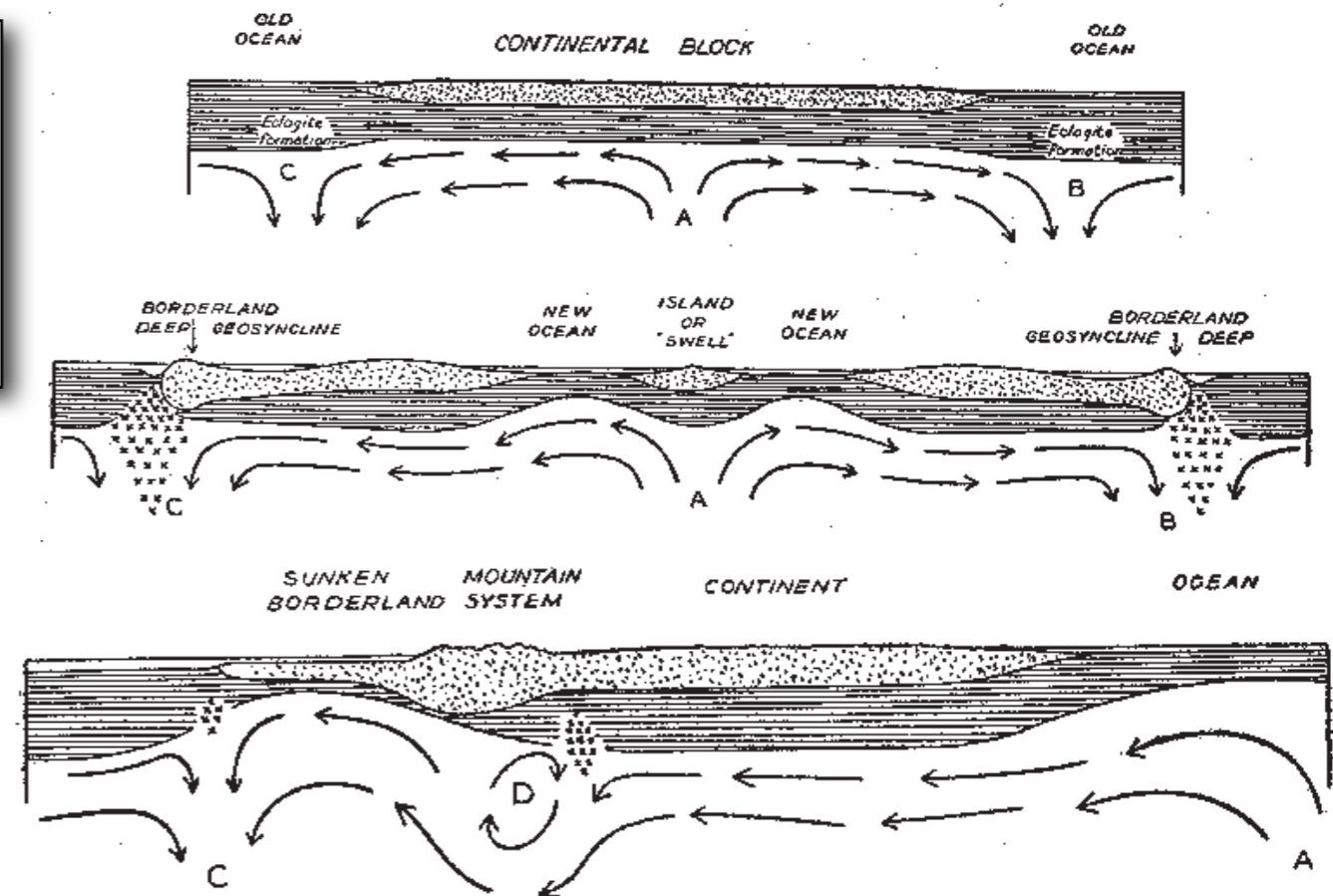

Fig. 4.

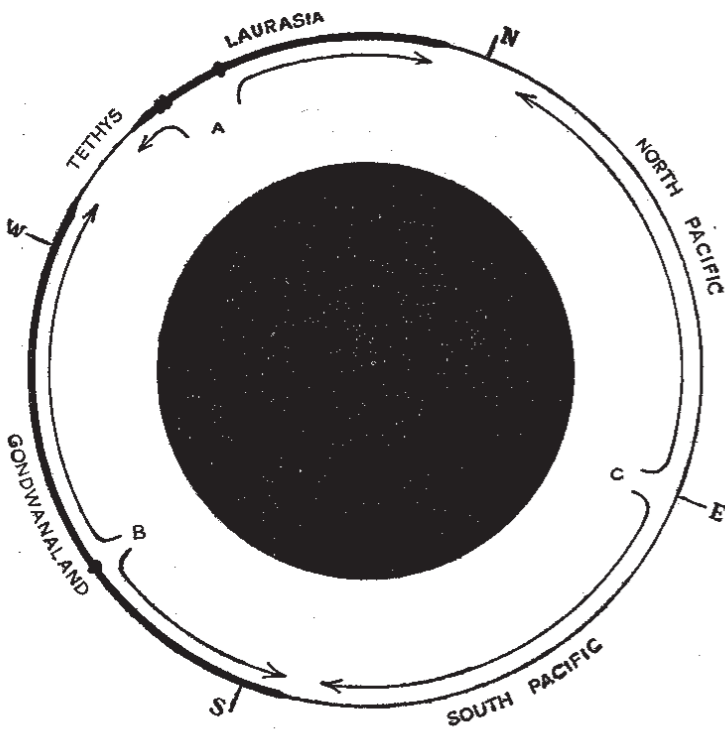

Fig. 5.

Arthur Holmes

Radioactivity and Earth Movements (1931)

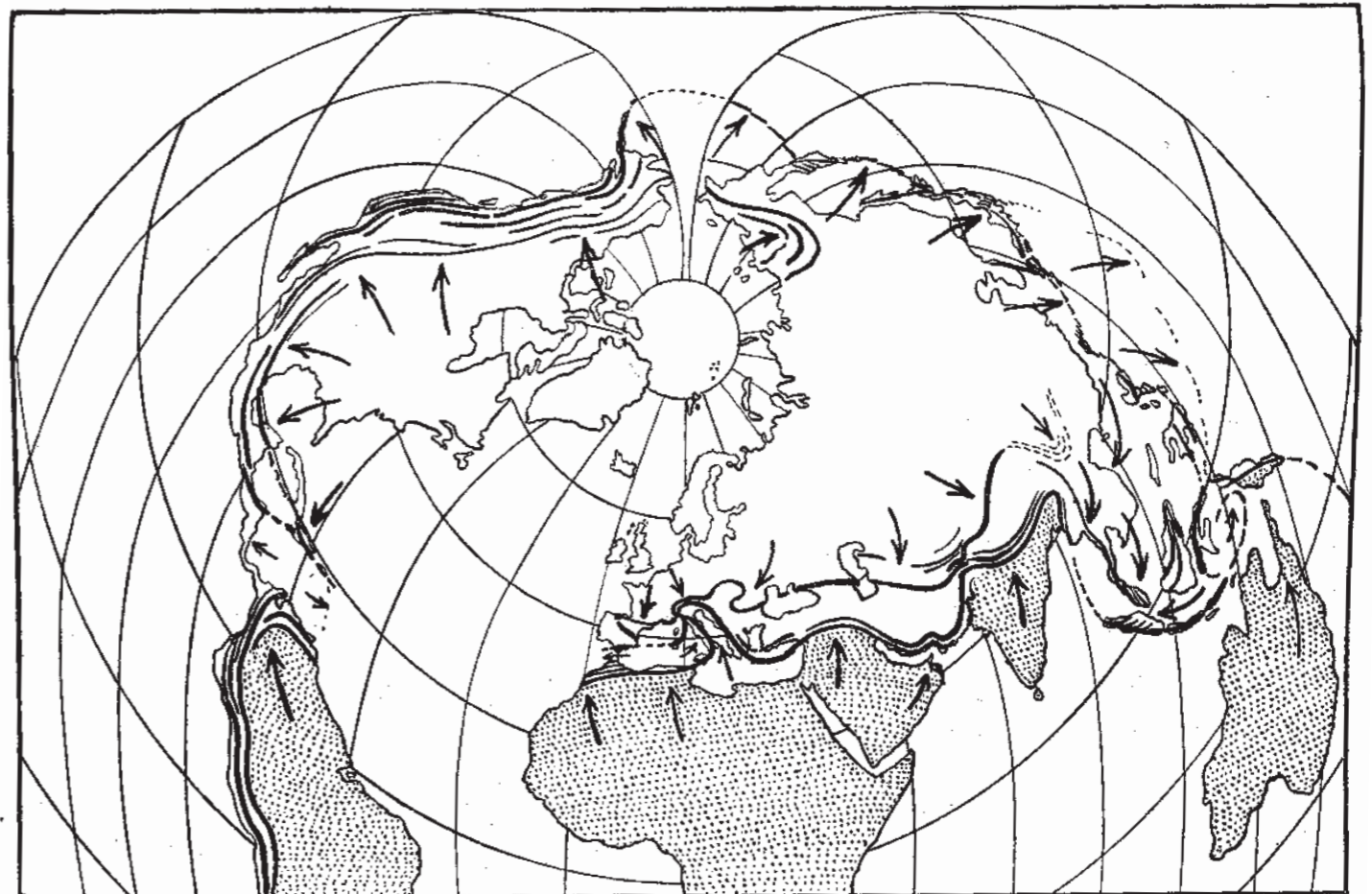

Fig. 6. Scale: 1 : 170 x 10<sup>8</sup>.



Chaleur de la Terre,  
convection et  
mouvements en surface,  
chaînes de montagnes...

PART OF THICKENED  
MEDIAN AREA      MOUNTAIN  
SYSTEM      BORDERING  
GEOSYNCLINE      FORELAND



Fig. 8

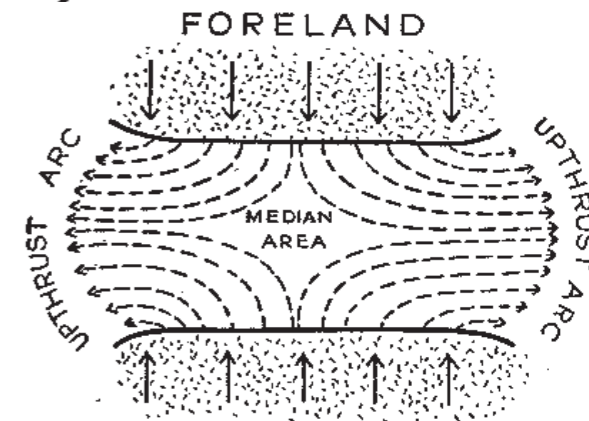

Fig. 9.

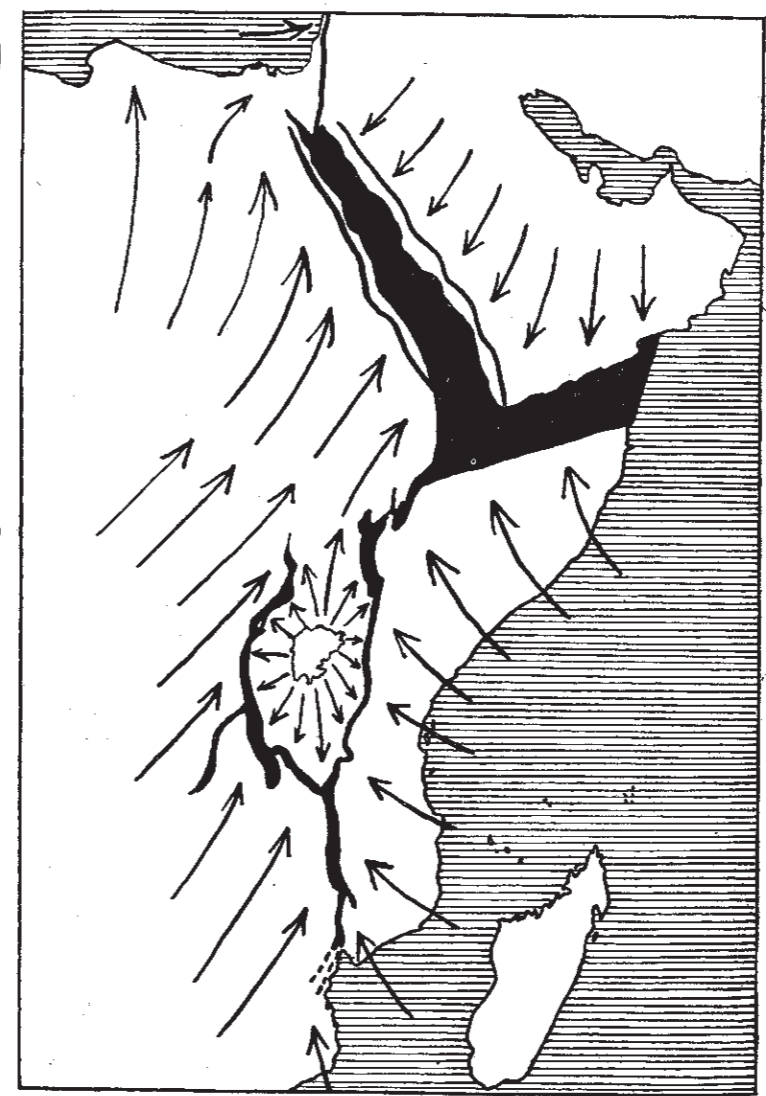

Fig. 10.

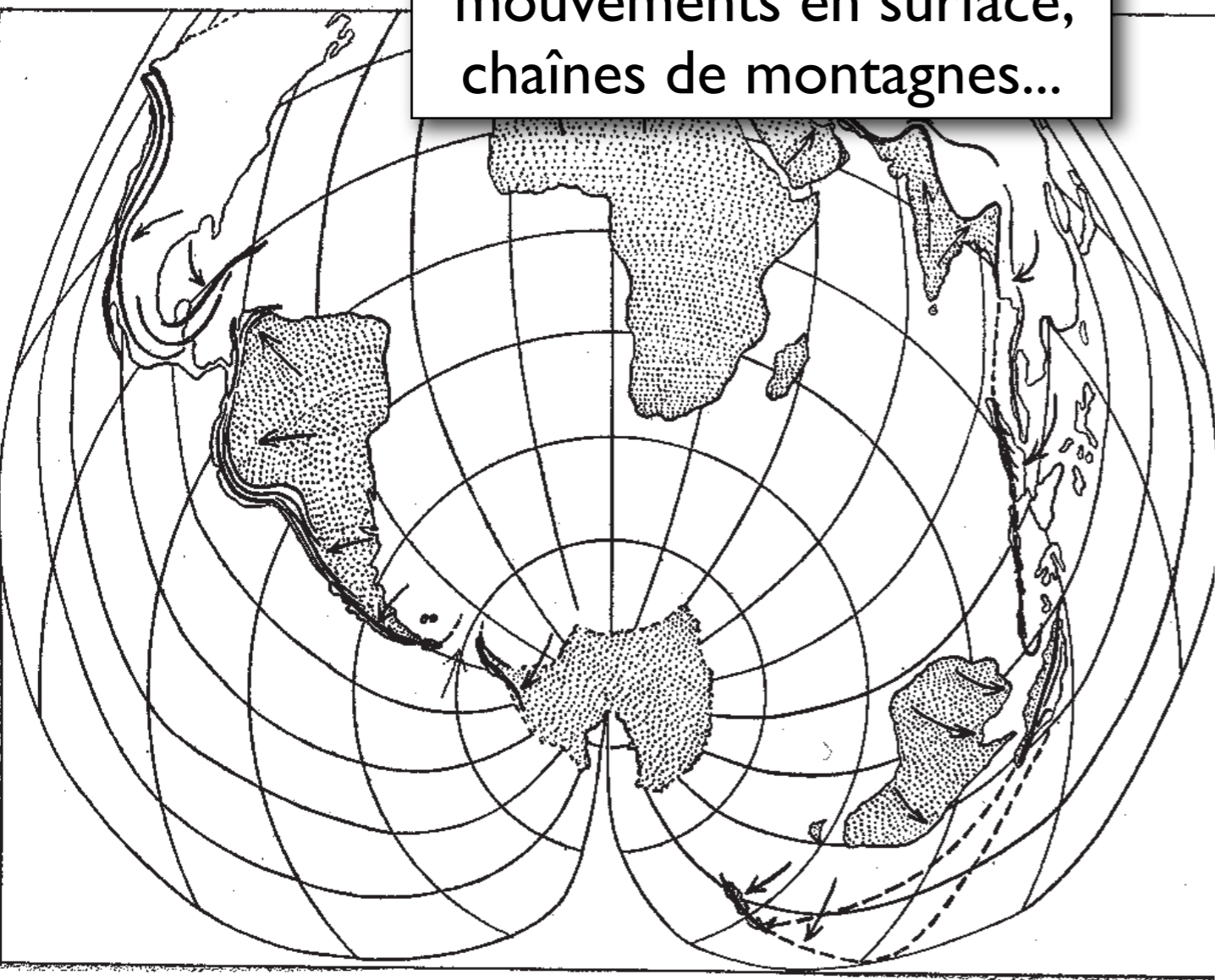

Fig. 7. Scale: 1 : 210 x 10<sup>6</sup>

Rift Valley

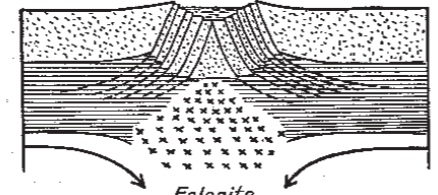

Fig. 12.

Thrusts in  
Rigid Sial

Basin

Thrusts in  
Rigid Sial

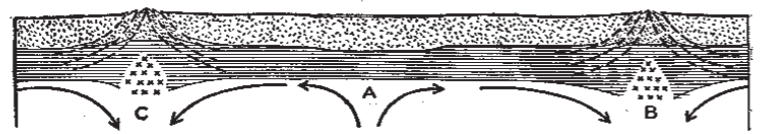

Fig. 11.



JEAN GOGUEL  
Ingénieur général des Mines  
Professeur à l'École des Mines de Paris  
Directeur du Service de la Carte géologique

INTRODUCTION

---

# TRAITÉ

DE

# TECTONIQUE

---

DEUXIÈME ÉDITION  
REVUE ET AUGMENTÉE

---

MASSON ET C<sup>e</sup>, ÉDITEURS  
120, Boulevard Saint-Germain, PARIS (VI<sup>e</sup>)

1965

FIG. 215.

Schéma montrant  
comment la descente  
du sima cristallisé  
dans le sima fondu  
moins dense  
peut faciliter  
l'écrasement  
de la partie supérieure  
de l'écorce.

(Inspiré  
d'une suggestion  
de R. A. DALY.)

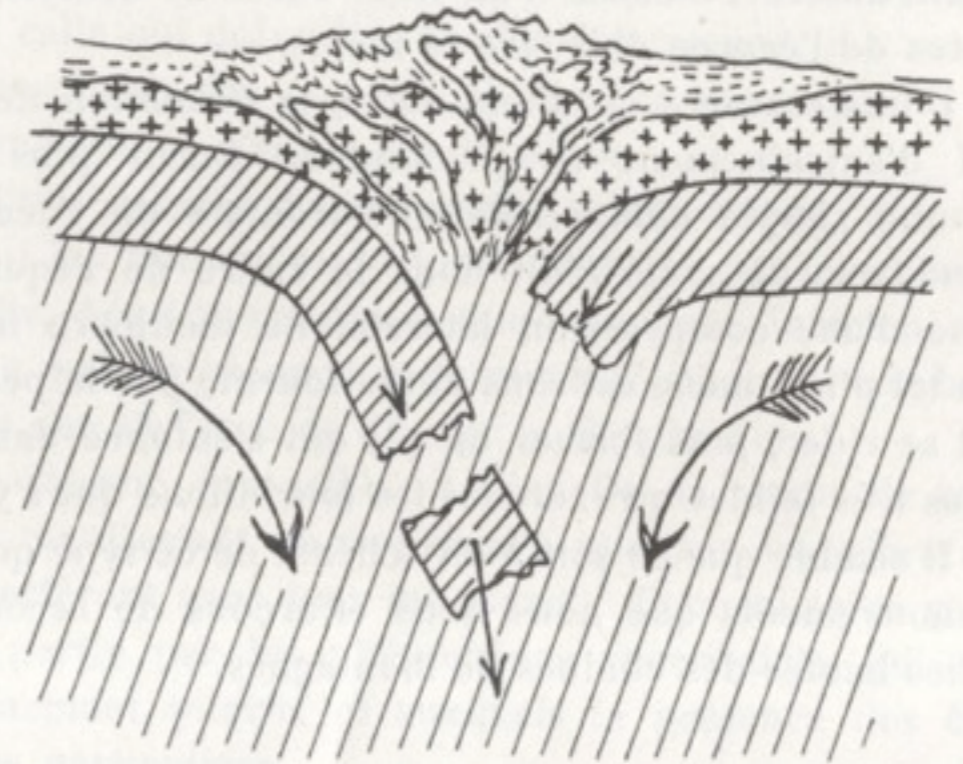

Jean Goguel (1952 et 1962)

JEAN GOGUEL  
Ingénieur général des Mines  
Professeur à l'École des Mines de Paris  
Directeur du Service de la Carte géologique

INTRODUCTION

---

# TRAITÉ

DE

# TECTONIQUE

---

DEUXIÈME ÉDITION  
REVUE ET AUGMENTÉE

---

MASSON ET C<sup>e</sup>, ÉDITEURS  
120, Boulevard Saint-Germain, PARIS (VI<sup>e</sup>)

1965

Fig. 215.

Schéma montrant  
comment la descente  
du sima cristallisé  
dans le sima fondu  
moins dense  
peut faciliter  
l'écrasement  
de la partie supérieure  
de l'écorce.

(Inspiré  
d'une suggestion  
de R. A. DALY.)

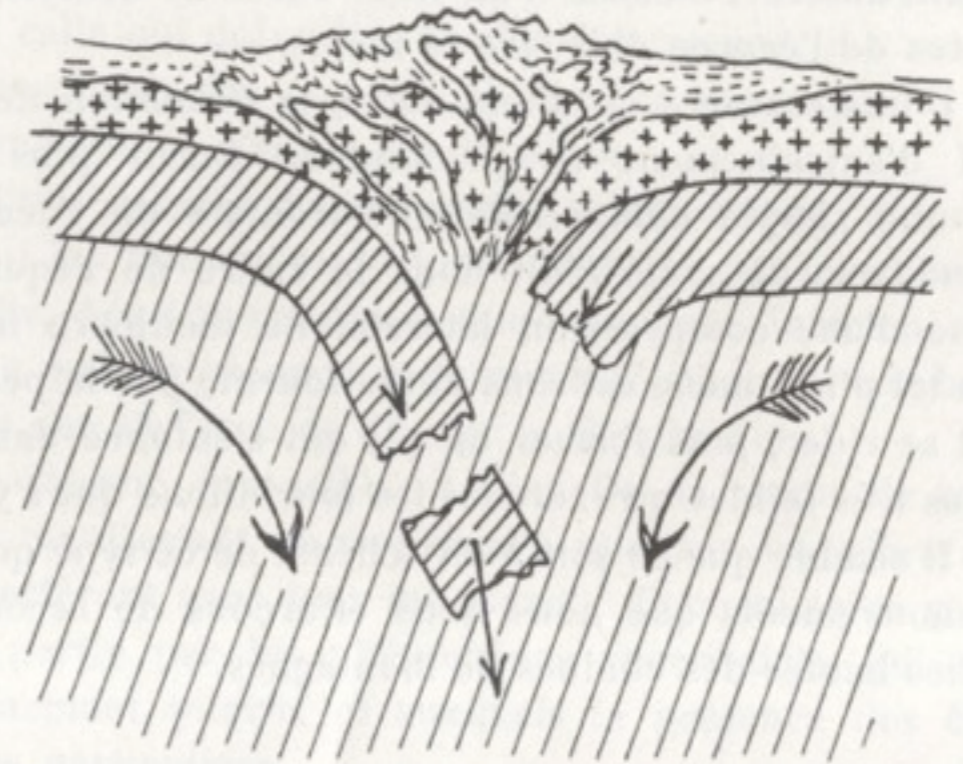

Jean Goguel (1952 et 1962)

**La solution viendra de la  
communauté des  
géophysiciens et de la  
découverte du domaine  
océanique**



L'étude du magnétisme  
des roches a fait faire un  
saut en avant considérable

**1853: Découverte de l'aimantation des roches: *Macedonio Melloni***

**1901, 1906: Découverte des inversions par *Bernard Bruhnes*; premières datations des inversions par *Matuyama***

**1952: Invention d'un magnétomètre capable de mesurer de très faibles champs magnétiques par *Patrick Blackett***

**1959: *Keith Runcorn* et *Ted Irving* mesure la mémoire magnétique des roches, ils inventent le paléomagnétisme.**

**1960: *John Reynolds* et *John Verhoogen* confirment les observations de *Matuyama* sur les inversions**

**1960: *Walter Elsasser* et *Ted Bullard* développent l'idée de la dynamo terrestre**

**1960-1966: Etablissement de la première échelle des inversions du champs sur les derniers 4 Ma par *Alan Cox*, *Richard Doell* et *Brent Dalrymple* (US Geological Survey), et *Ian McDougall* et *François Chamalun* (Australian National University).**

# Le paléomagnétisme a fourni les premières preuves indépendantes de la dérive des continents

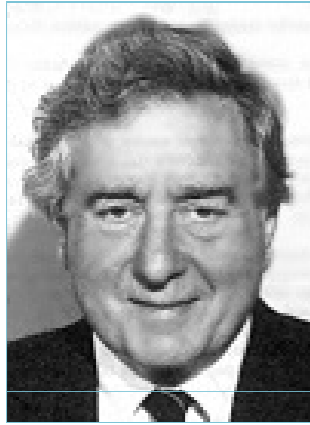

Keith Runcorn

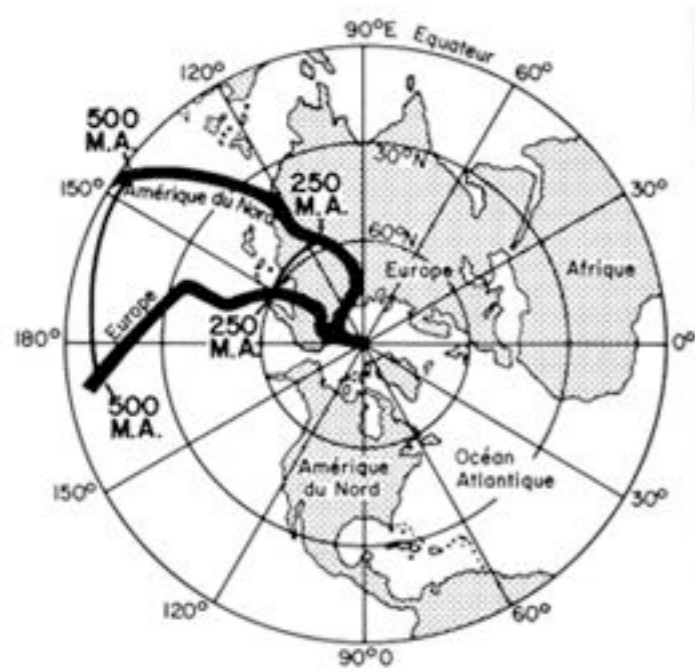

Runcorn, S.K.: Palaeomagnetic evidence for continental drift and its geophysical cause, in S.K. Runcorn (ed) Continental Drift, New York, Academic Press, 1962

Courbes de dérive du pôle pour l'Europe et l'Amérique

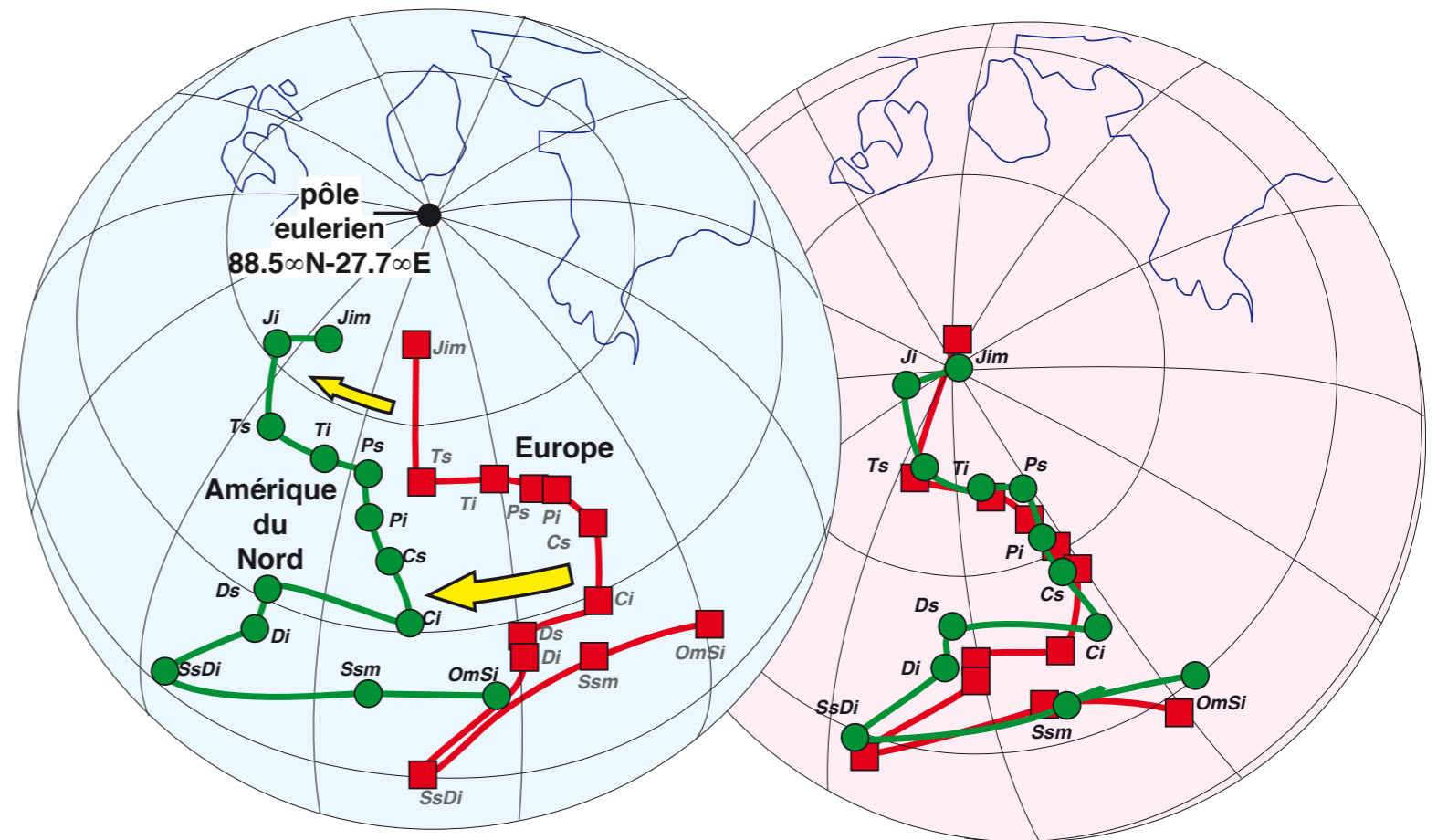

Actuel

Reconstruction anté-ouverture de l'Atlantique



# La première échelle des inversions du champ magnétique a fourni la base de la théorie de l'expansion des fonds océaniques



Allan Cox (seated), Richard Doell (L), and Brent Dalrymple (R) at a gas mass spectrometer. This photo was taken sometime in the early 1960s. Image courtesy of Stanford School of Earth Sciences.

The first figure by Cox, Dalrymple, and Doell shows Earth's magnetic reversals and the beginnings of the Geomagnetic Polarity Time Scale. (mod. from *Science*, 1963)

[quake06.stanford.edu/centennial/tour/stop11.html](http://quake06.stanford.edu/centennial/tour/stop11.html)

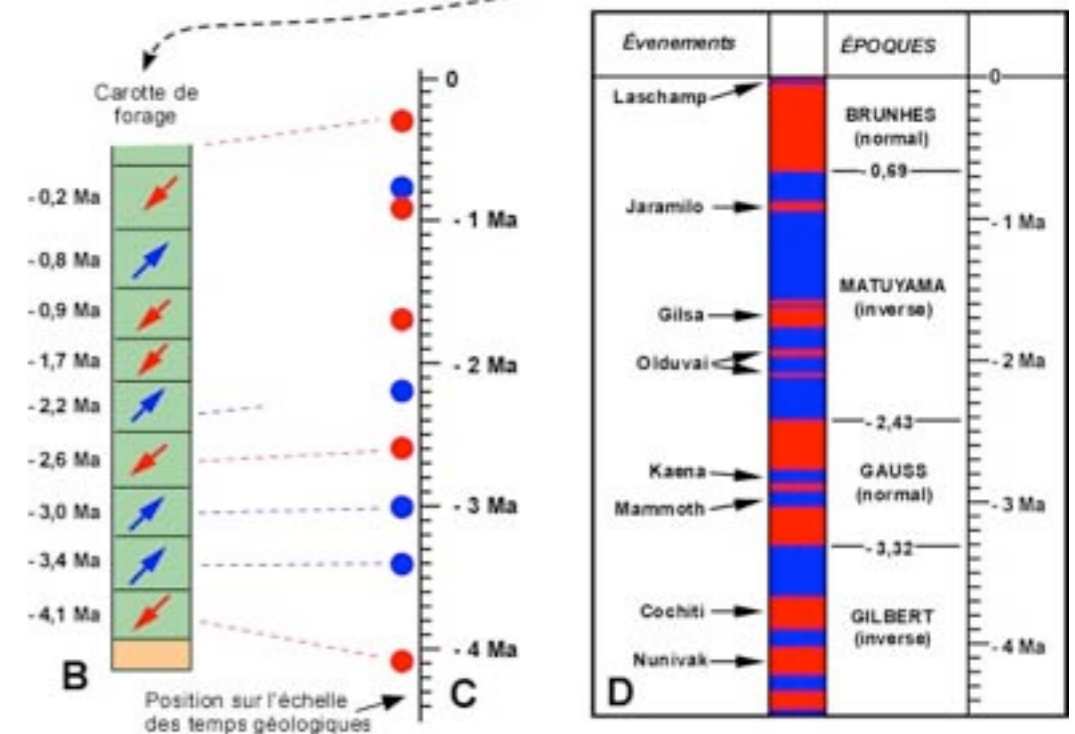
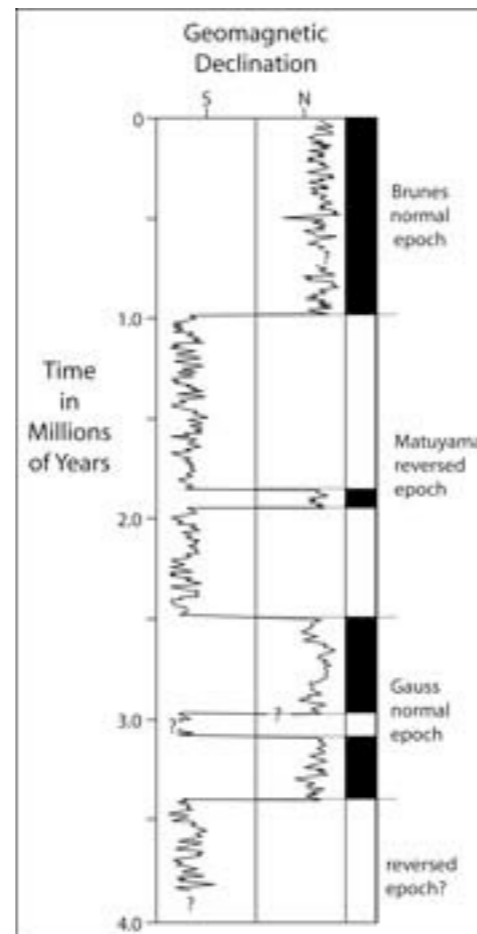
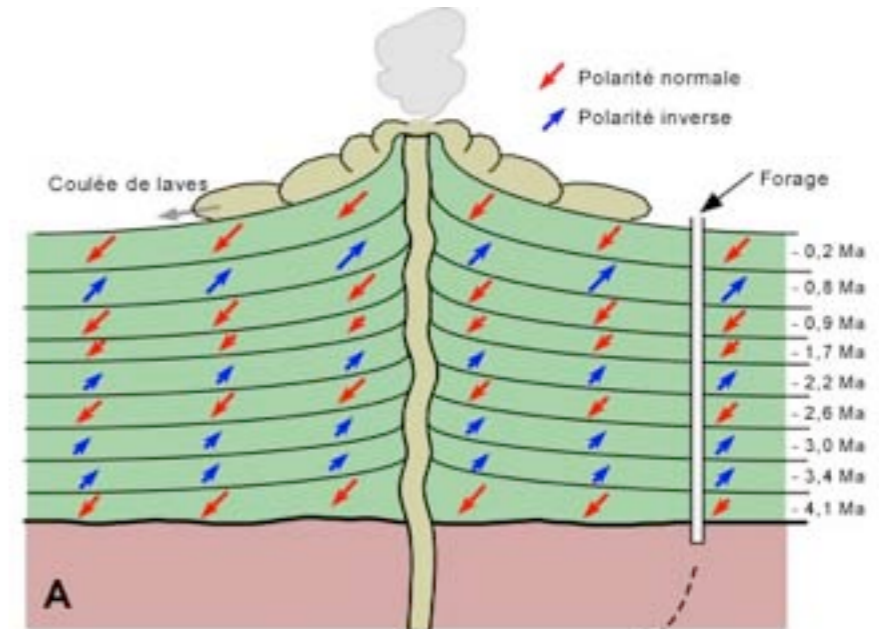

## **L'hypothèse de l'expansion océanique et sa vérification**

Au début des années 1960, les découvertes de la topographie océanique et des variations du flux thermique permettent d'imaginer une expansion océanique par accrétion de matériau remontant à l'axe des dorsales, conséquence d'une convection profonde.

La mise en évidence de bandes d'anomalies magnétiques symétriques par rapport à l'axe des dorsales océaniques, corrélables avec les phénomènes d'inversion des pôles magnétiques (connus depuis le début du siècle) permet d'éprouver cette hypothèse et de calculer des vitesses d'expansion.





Maurice Ewing et le *Vema*

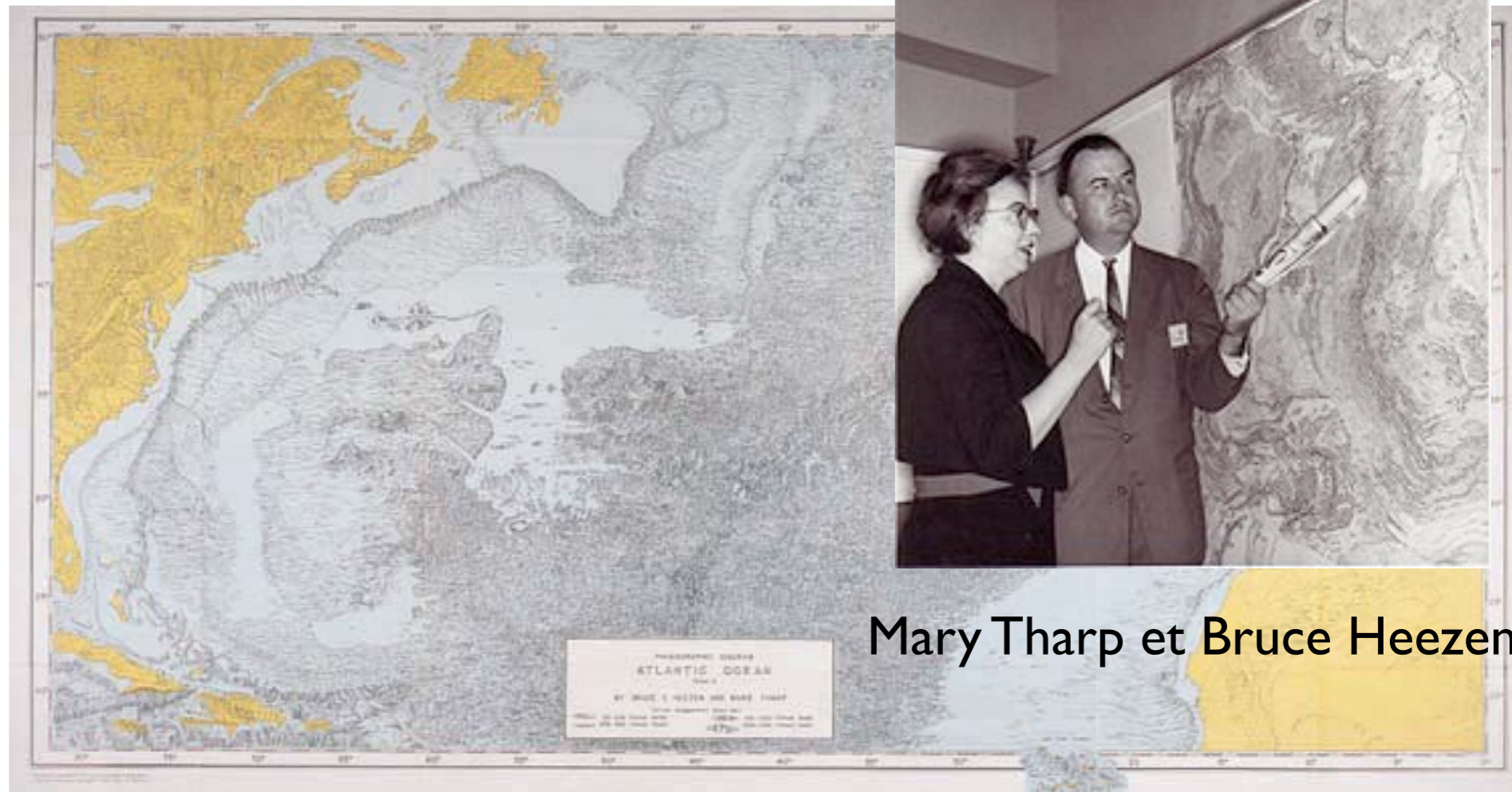

Mary Tharp et Bruce Heezen



## Découverte des dorsales médio- océaniques...

Les campagnes océanographiques des années 50 ont permis la mise en évidence de montagnes sous la mer sur plus de 50 000 km. Chaque océan à la sienne.



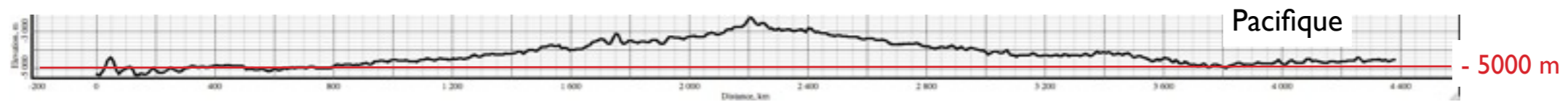
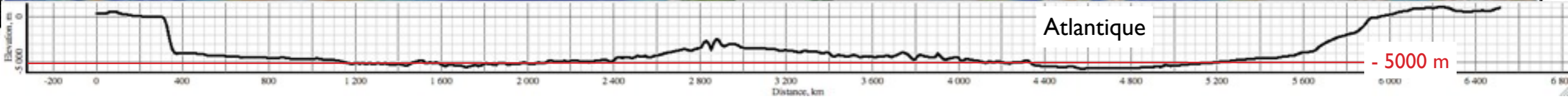
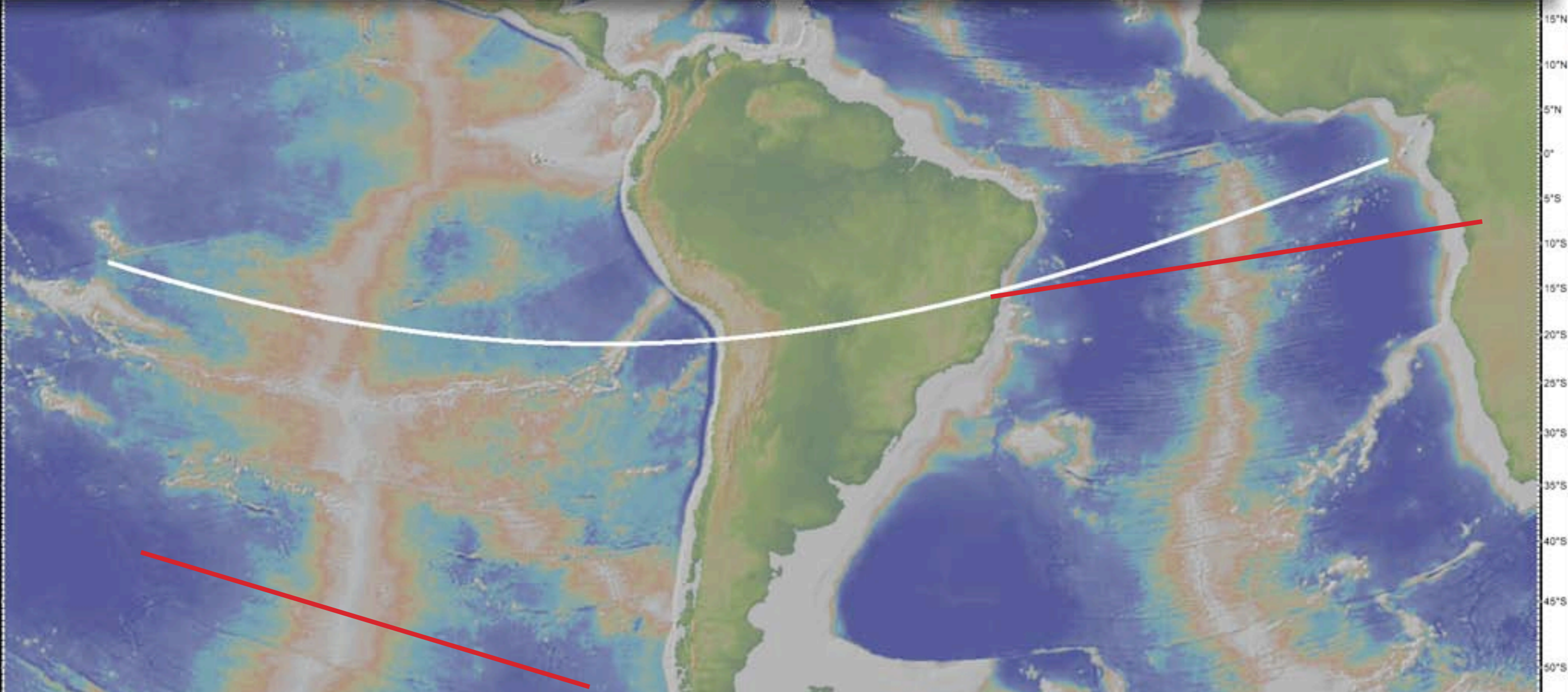
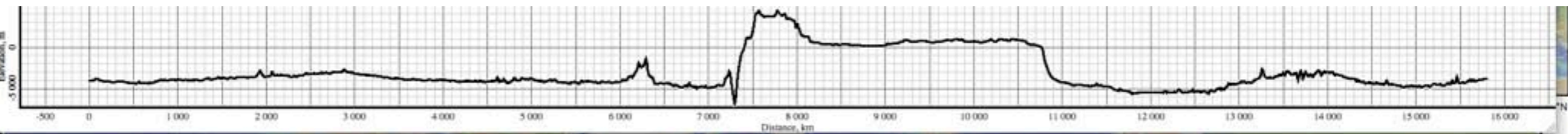



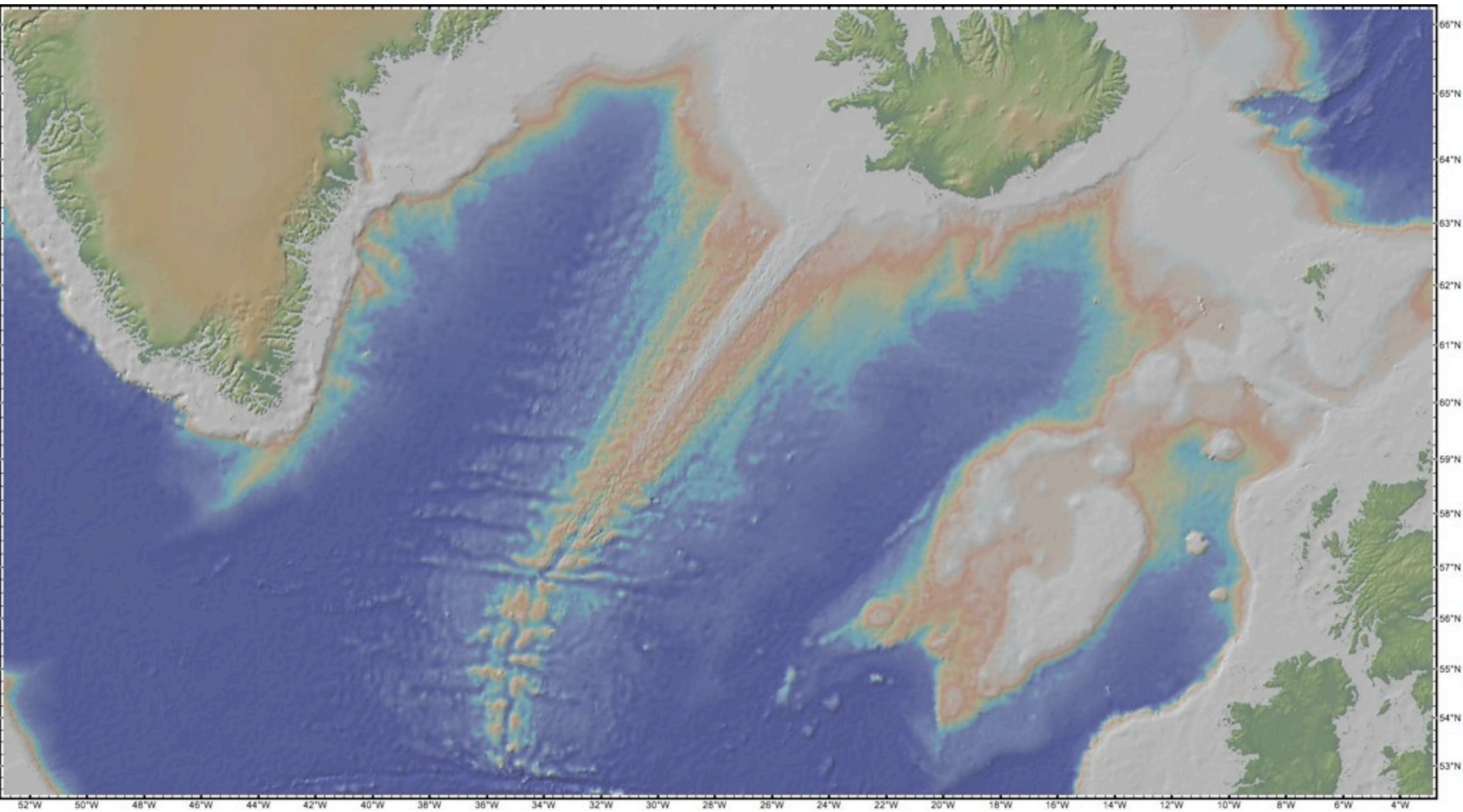





Harry Hess, 1962

Au départ l'expansion des fonds océaniques est une hypothèse formulée en particulier par Robert S. Dietz (1961) et Harry H. Hess (1962)

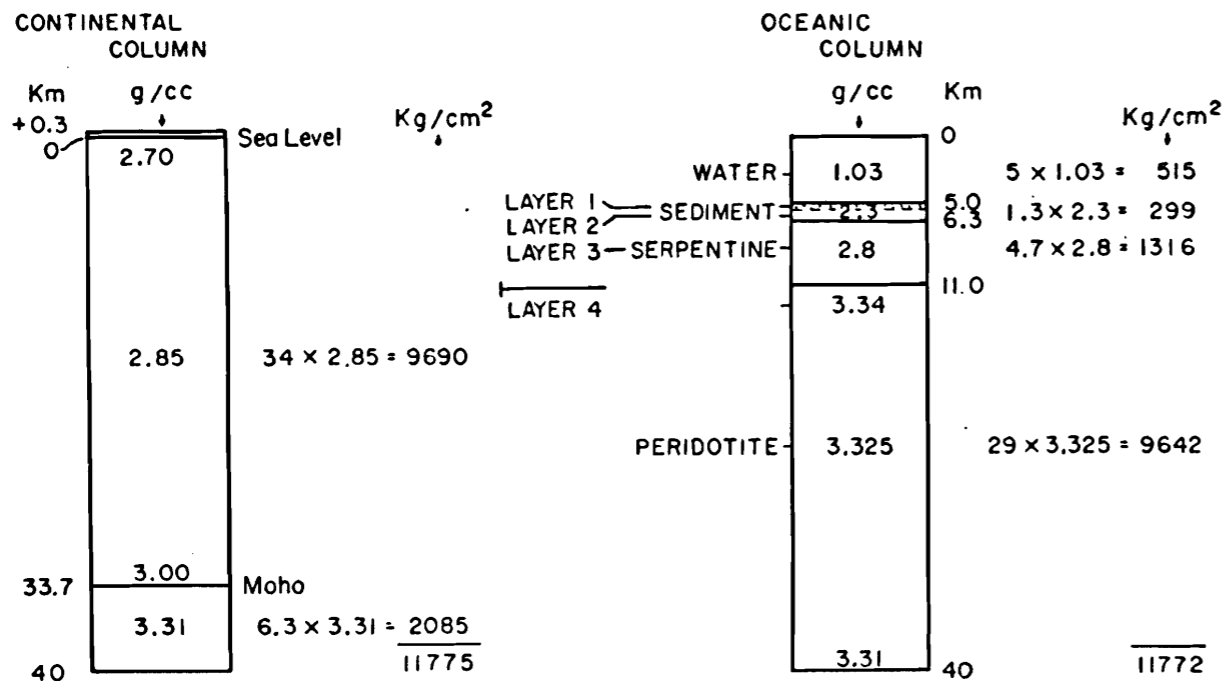

Figure 2. Balance of oceanic and continental crustal columns

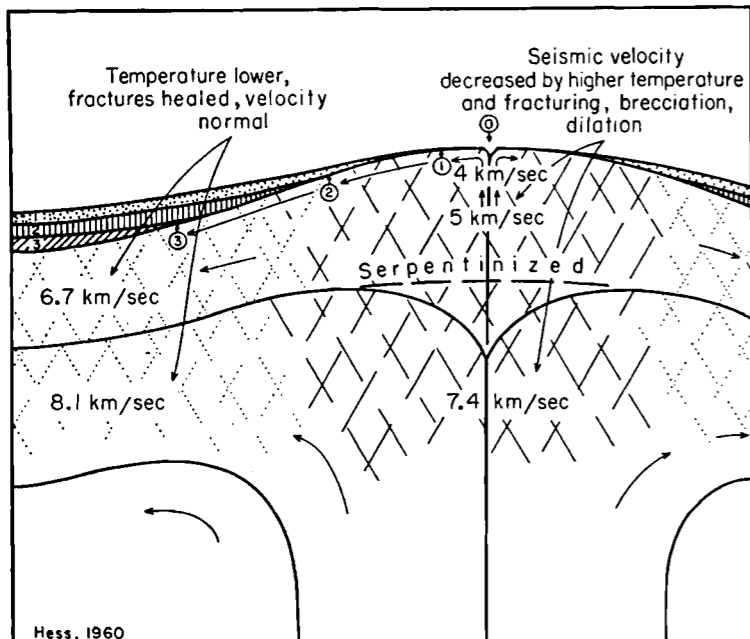

Figure 7. Diagram to represent (1) apparent progressive overlap of ocean sediments on a mid-ocean ridge which would actually be the effect of the mantle moving laterally away from ridge crest, and (2) the postulated fracturing where convective flow changes direction from vertical to horizontal. Fracturing and higher temperature could account for the lower seismic velocities on ridge crests, and cooling and healing of the fractures with time, the return to normal velocities on the flanks.

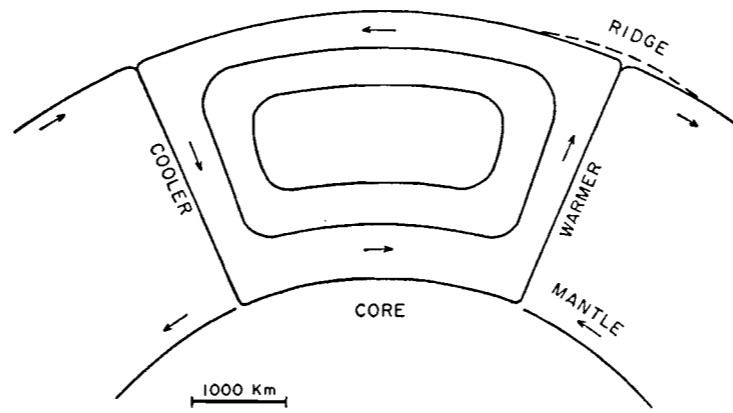

Figure 8. Possible geometry of a mantle convection cell

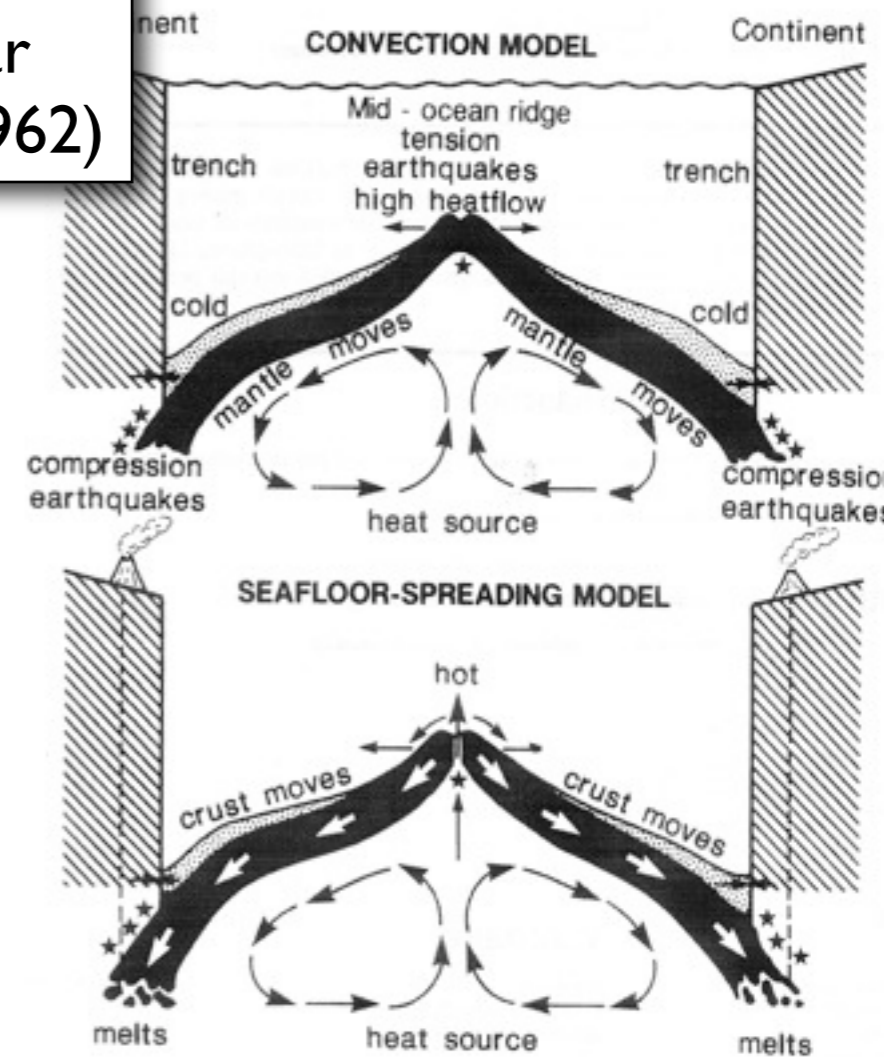

Figure 9. Diagram to show progressive migration of volcanic peaks, guyots, and atolls, from a ridge crest to the flanks, suggesting that the wave-cut surfaces of guyots or the bases of atolls may become older laterally away from the crest

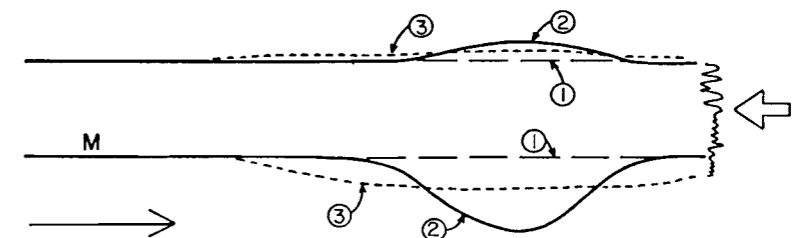

Figure 12. Diagram to illustrate thickening of a continent by deformation. Initially a mountain system and much larger root are formed, but both spread laterally with time and isostatic adjustment



## CONTINENT AND OCEAN BASIN EVOLUTION BY SPREADING OF THE SEA FLOOR

By ROBERT S. DIETZ,

U.S. Navy Electronics Laboratory, San Diego 52, California

ANY concept of crustal evolution must be based on an Earth model involving assumptions not fully established regarding the nature of the Earth's outer shells and mantle processes. The concept proposed here, which can be termed the 'spreading sea-floor theory', is largely intuitive, having been derived through an attempt to interpret sea-floor bathymetry. Although no entirely new proposals need be postulated regarding crustal structure, the concept requires the acceptance of a specific crustal model, in some ways at variance with the present consensus of opinion. Since the model follows from the concept, no attempt is made to defend it. The assumed model is as follows:

(1) Large-scale thermal convection cells, fuelled by the decay of radioactive minerals, operate in the mantle. They must provide the primary diastrophic forces affecting the lithosphere.

(2) The sequence of crustal layers beneath the oceans is markedly different from that beneath the continents and is quite simple (Fig. 1). On an average 4.5 km. of water overlies 0.3 km. of unconsolidated sediments (layer 1). Underlying this is layer 2, consisting of about 2.0 km. of mixed volcanics and lithified sediments. Beneath this is the layer 3 (5 km. thick), commonly called the basalt layer and supposedly forming a world-encircling cap of effusive basic volcanics over the Earth's mantle from which it is separated by the Mohorovičić seismic discontinuity. Instead we must accept the growing opinion that the 'Moho' marks a change of phase rather than a chemical boundary, that is, layer 3 is chemically the same as the mantle rock but petrographically different with low-pressure phase minerals above the Moho and high-pressure minerals below. This change of phase may be either from eclogite to gabbro<sup>1</sup>, or from peridotite to serpentine<sup>2</sup>; its exact nature is not vital to our concept, but we can tentatively accept the eclogite-gabbro transition as it has more adherents. Common usage requires that we reserve the term 'mantle' for the substance beneath the

## Spreading Sea Floor Theory

Owing to the small strength of the lithosphere and the gradual transition in rigidity between it and the asthenosphere, the lithosphere is not a boundary to convection circulation, and neither is the Moho beneath the oceans because this is not a density boundary but simply a change of phase. Thus the oceanic 'crust' (the gabbroic layer) is almost wholly coupled with the convective overturn of the mantle creeping at a rate of a few cm./yr. Since the sea floor is covered by only a thin veneer of sediments with some mixed-in effusives, it is essentially the outcropping mantle. So the sea floor marks the tops of the convection cells and slowly spreads from zones of divergence to those of convergence. These cells have dimensions of several thousands of kilometres; some cells are quite active now while others are dead or dormant. They have changed position with geological time causing new tectonic patterns.



L'introduction du terme «sea-floor spreading» par l'océanographe américain Robert S. Dietz (1914-1995) en 1961

(repris du cours de C. Sengör au Collège de France en 2005)



La découverte des anomalies magnétiques par Raff et Mason (1961) puis leur interprétation indépendamment par L. Morley et Vine & Matthews fournissent des preuves de la réalité de ce processus

MAGNETIC ANOMALIES OVER OCEANIC RIDGES

By F. J. VINE and DR. D. H. MATTHEWS  
 Department of Geodesy and Geophysics, University of Cambridge

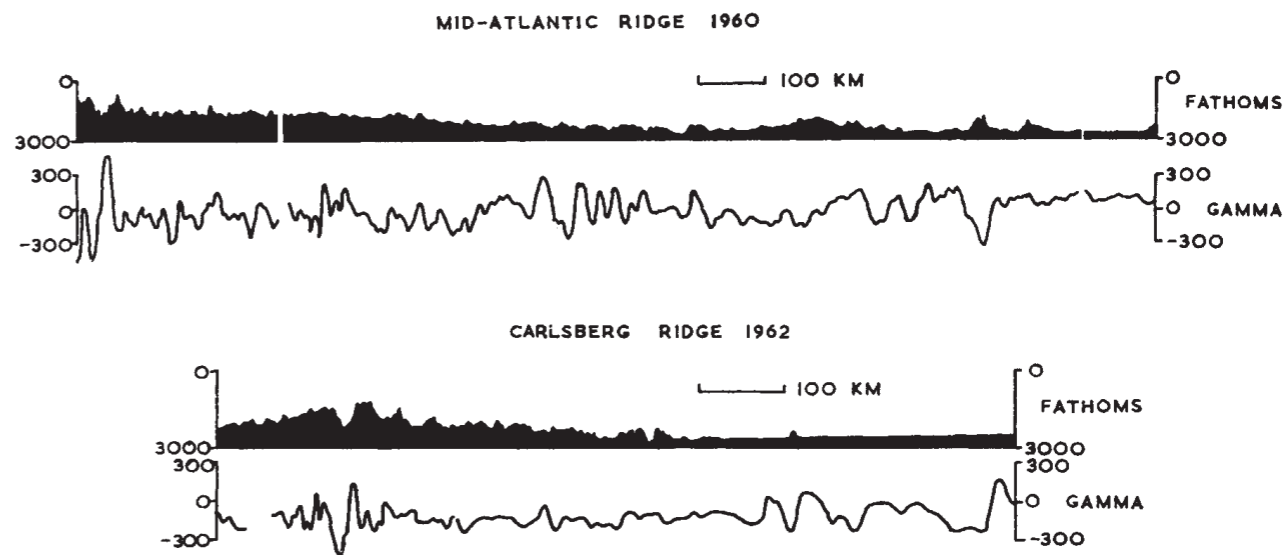
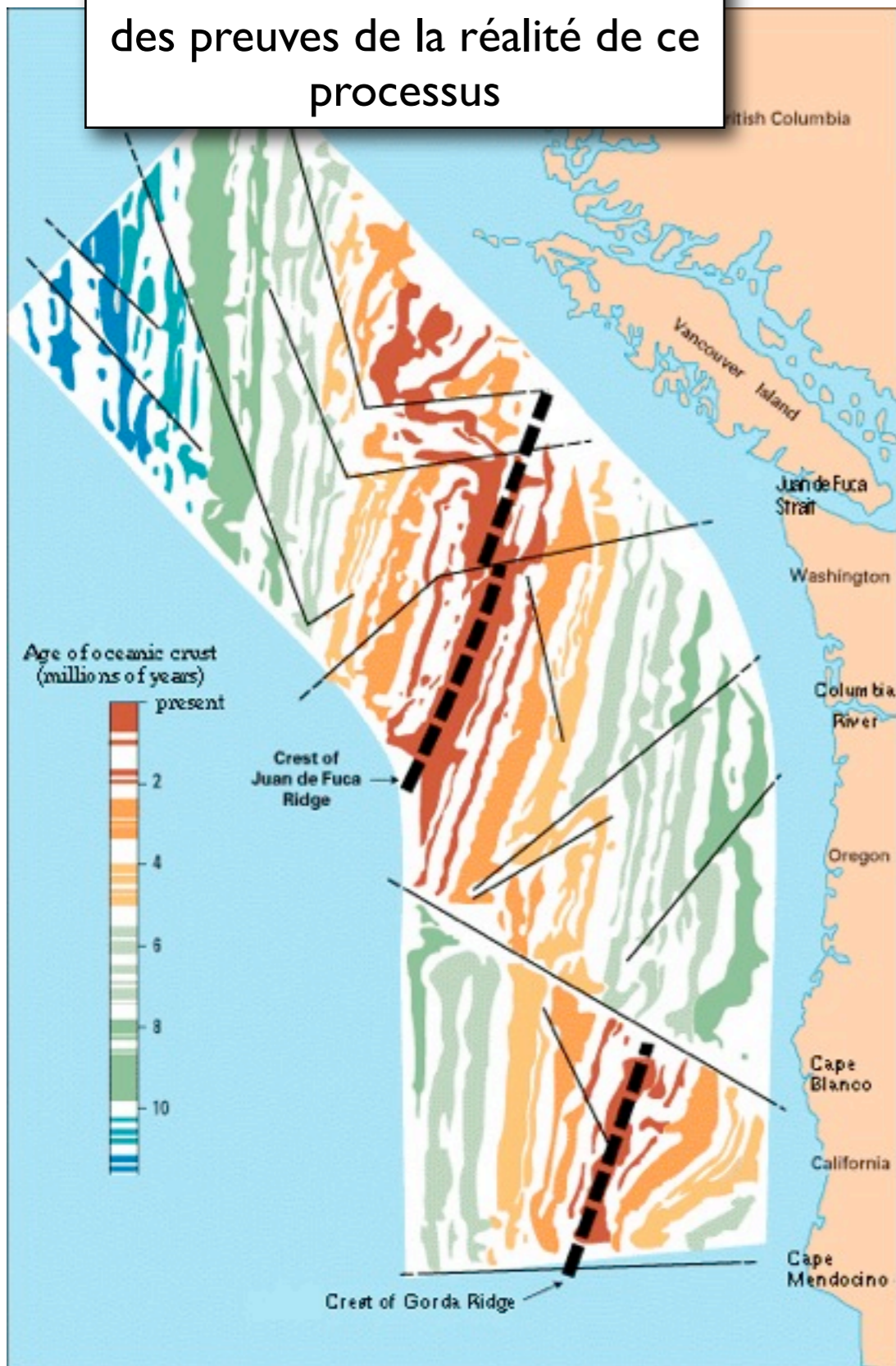

Fig. 1. Profiles showing bathymetry and the associated total magnetic field anomaly observed on crossing the North Atlantic and the north-west Indian Oceans. Upper profile from 45° 17' N, 28° 27' W. to 45° 19' N, 11° 29' W. Lower profile from 30° 5' N, 61° 57' E. to 10° 10' N, 66° 27' E.



Lawrence W. Morley



Matthews, Vine et McKenzie

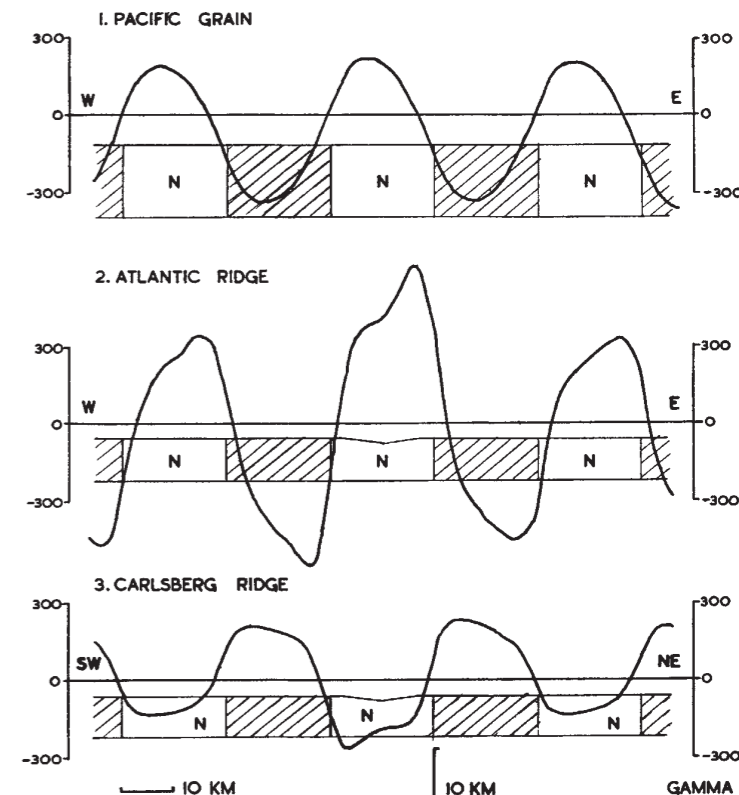
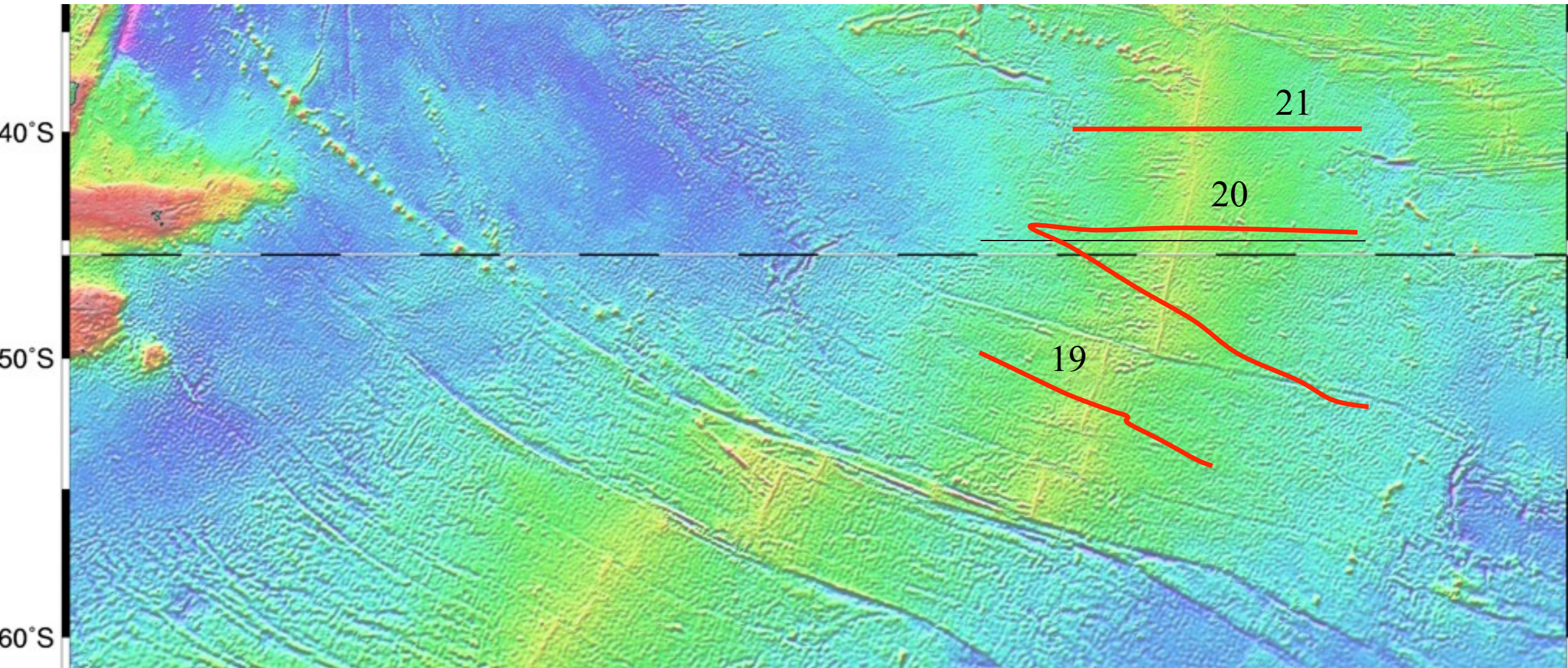

Fig. 4. Magnetic profiles computed for various crustal models. Crustal blocks marked N, normally magnetized; diagonally shaded blocks, reversely magnetized. Effective susceptibility of blocks, 0.0027, except for the block under the median valley in profiles 2 and 3, 0.0053.



Il faut attendre la publication du «magic profile»  
pour que l'ensemble des géophysiciens soit  
convaincu



**Routes du navire océanographique Eltanin en 1960 (Columbia University) pour enregistrer les variations du champ magnétique**



# Profil magnétique enregistré par l'Eltanin

la ligne rouge représente l'absence d'anomalie

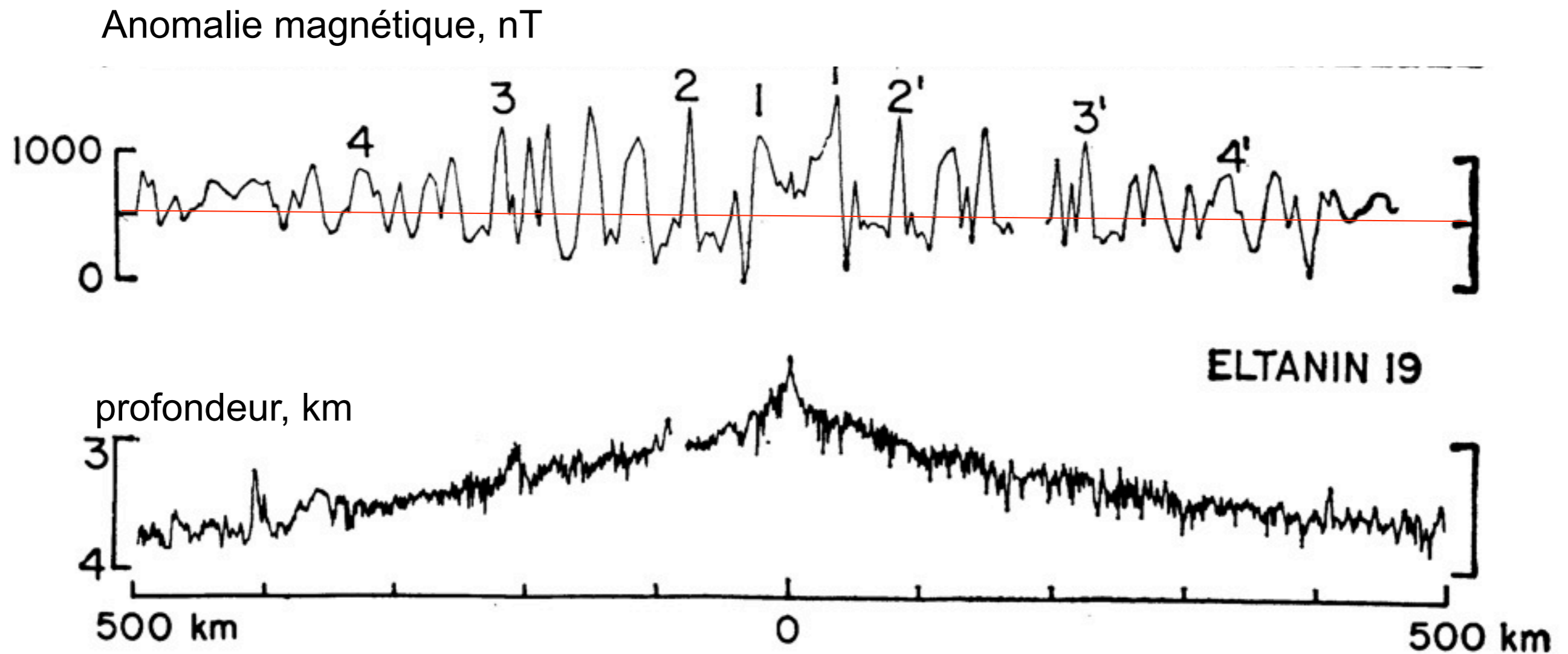



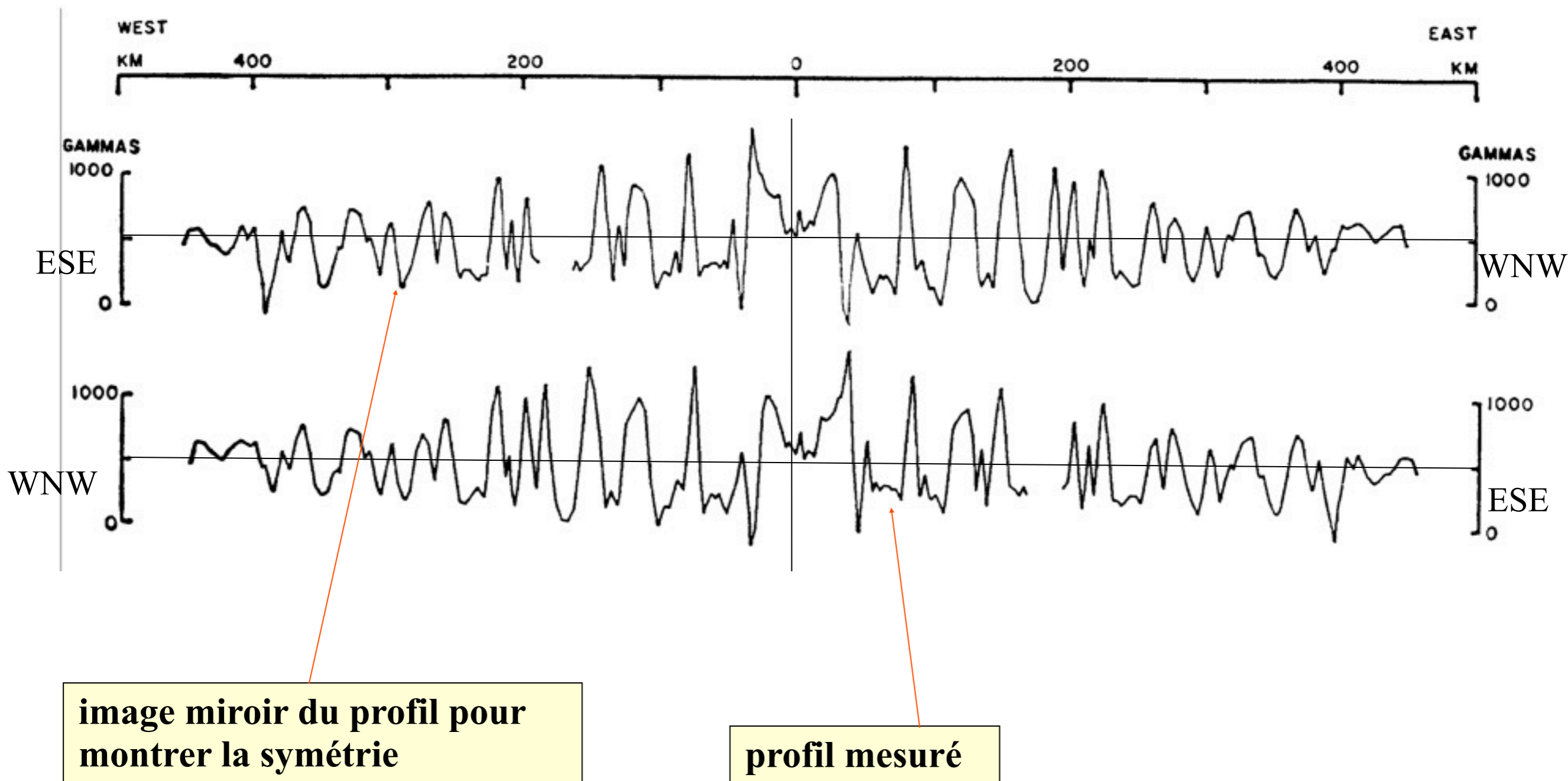

## la symétrie du profil Eltanin 19



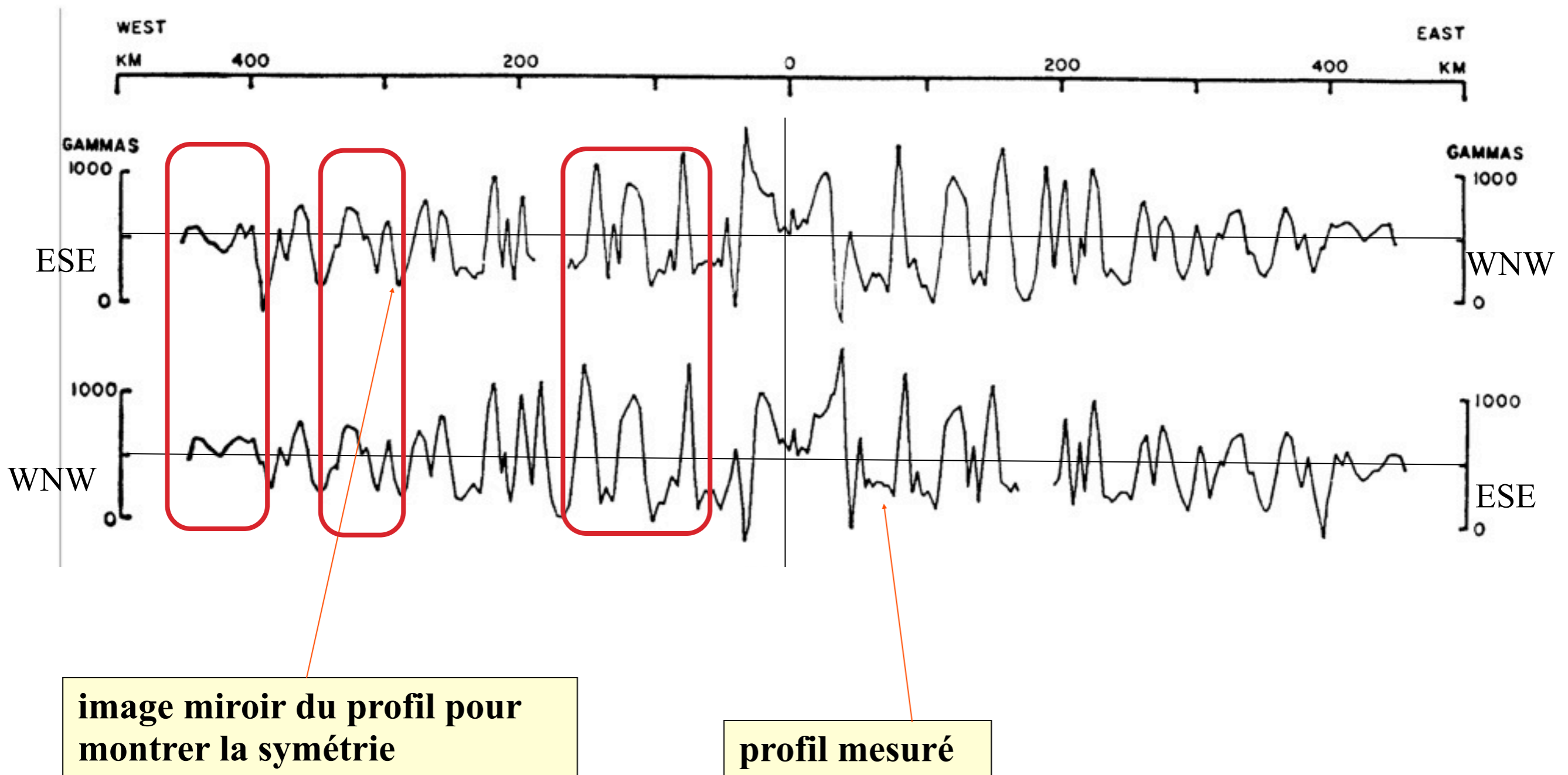

## la symétrie du profil Eltanin 19

# Marine Magnetic Anomalies, Geomagnetic Field Reversals, and Motions of the Ocean Floor and Continents<sup>1</sup>

J. R. HEIRTZLER,<sup>2</sup> G. O. DICKSON, E. M. HERRON,  
W. C. PITMAN, III, AND X. LE PICHON<sup>3</sup>

*Lamont Geological Observatory, Columbia University  
Palisades, New York 10964*

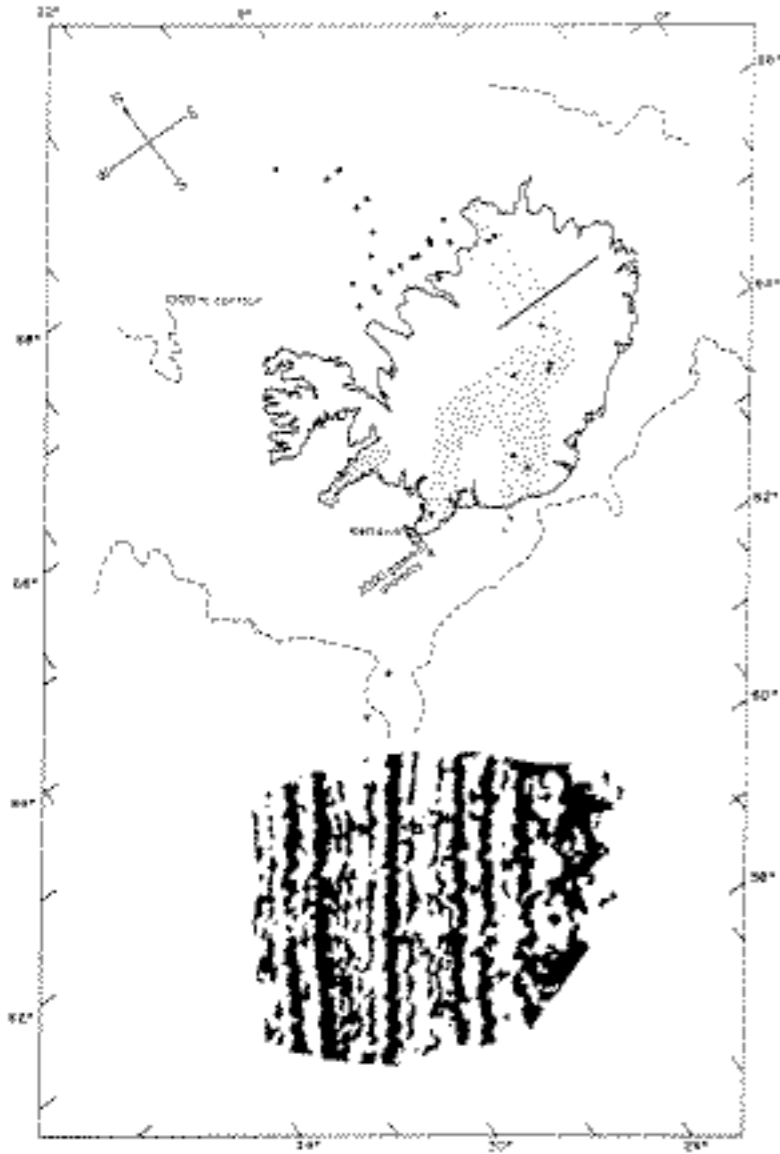

Carte des anomalies magnétiques su sud de l'Islande [Heirtzler, 1968]

[www-istp.gsfc.nasa.gov/earthmag/mill\\_6.htm](http://www-istp.gsfc.nasa.gov/earthmag/mill_6.htm)

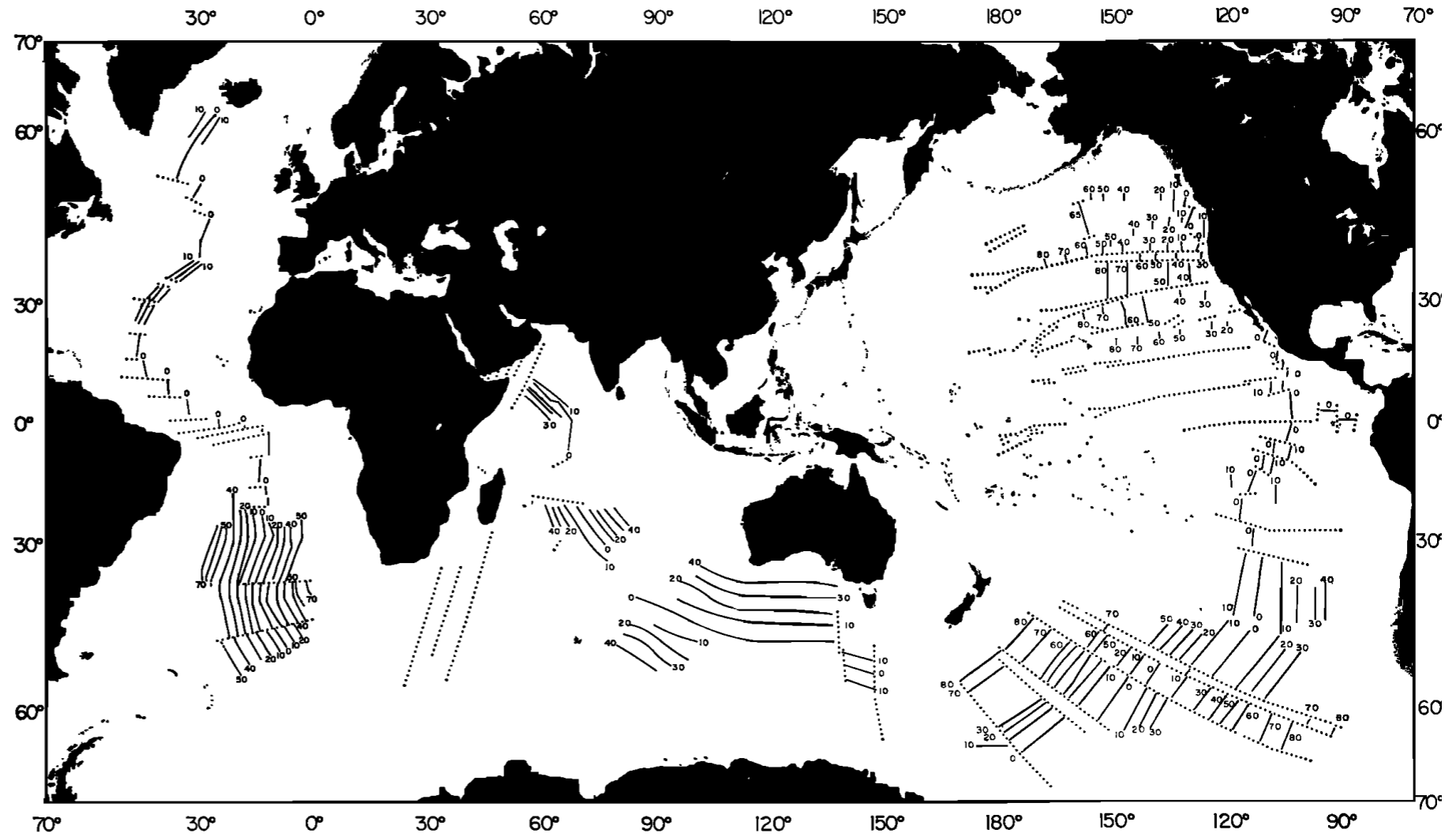
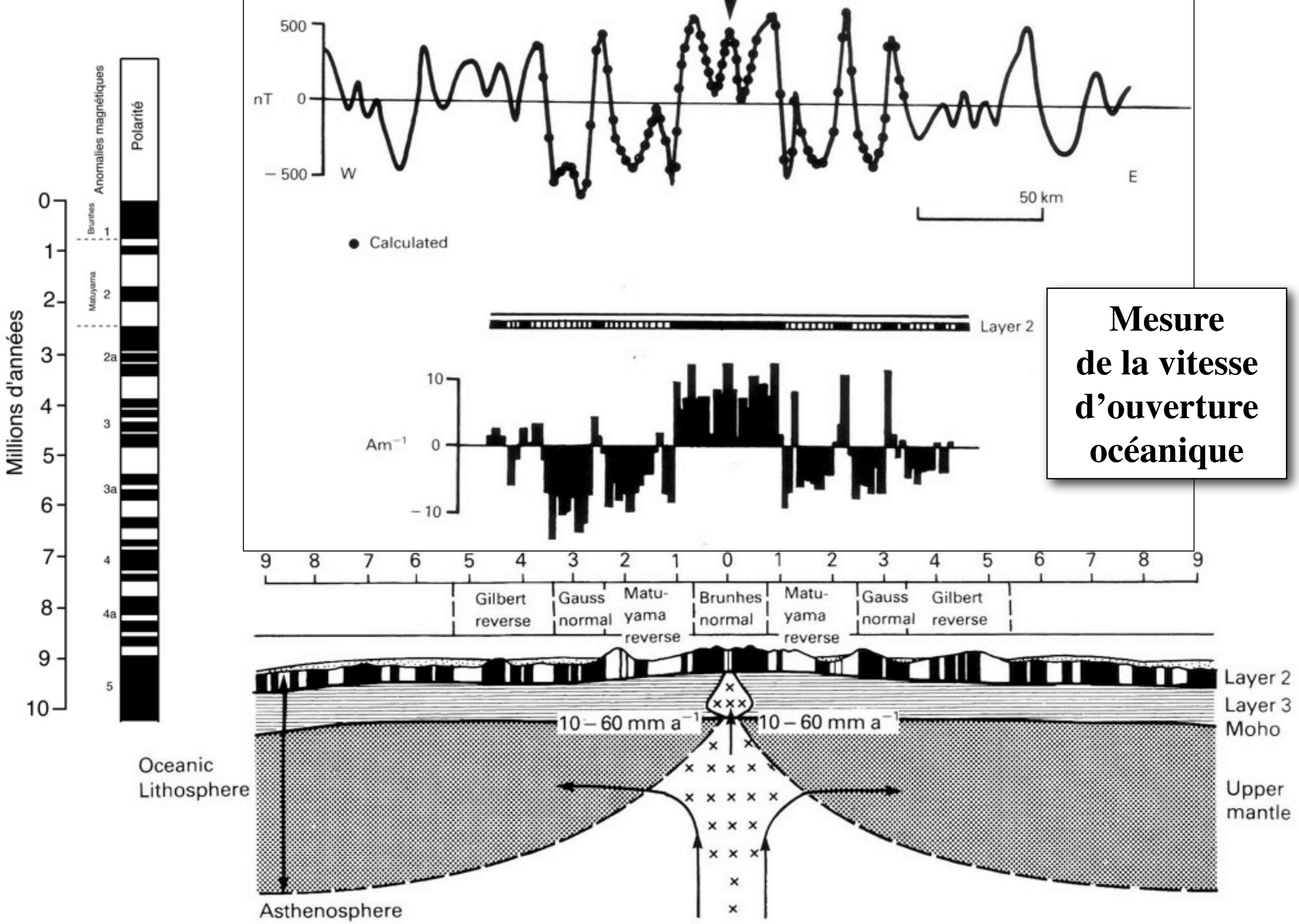

Fig. 4. Isochron map of the ocean floor according to the magnetic anomaly pattern. Numbers on isochron lines represent age in millions of years. Dotted lines represent fracture zones.





**Mesure  
de la vitesse  
d'ouverture  
océanique**

## Les concepts de lithosphère et d'asthénosphère

Au voisinage des fosses océaniques, la distribution spatiale des foyers des séismes en fonction de leur profondeur s'établit selon un plan incliné.

Les différences de vitesse des ondes sismiques qui se propagent le long de ce plan, par rapport à celles qui s'en écartent, permettent de distinguer : la lithosphère de l'asthénosphère.

L'interprétation de ces données sismiques permet ainsi de montrer que la lithosphère s'enfonce dans le manteau au niveau des fosses dites de subduction.

La limite inférieure de la lithosphère correspond généralement à l'isotherme 1300°C.



En observant les mouvements verticaux liés à la vidange du Lac Bonneville, Grove Gilbert discute en 1890 la notion d'isostasie et propose de substituer à l'isostasie locale (voir les théories de Pratt et Airy) la notion d'isostasie régionale impliquant une rigidité de la croûte.

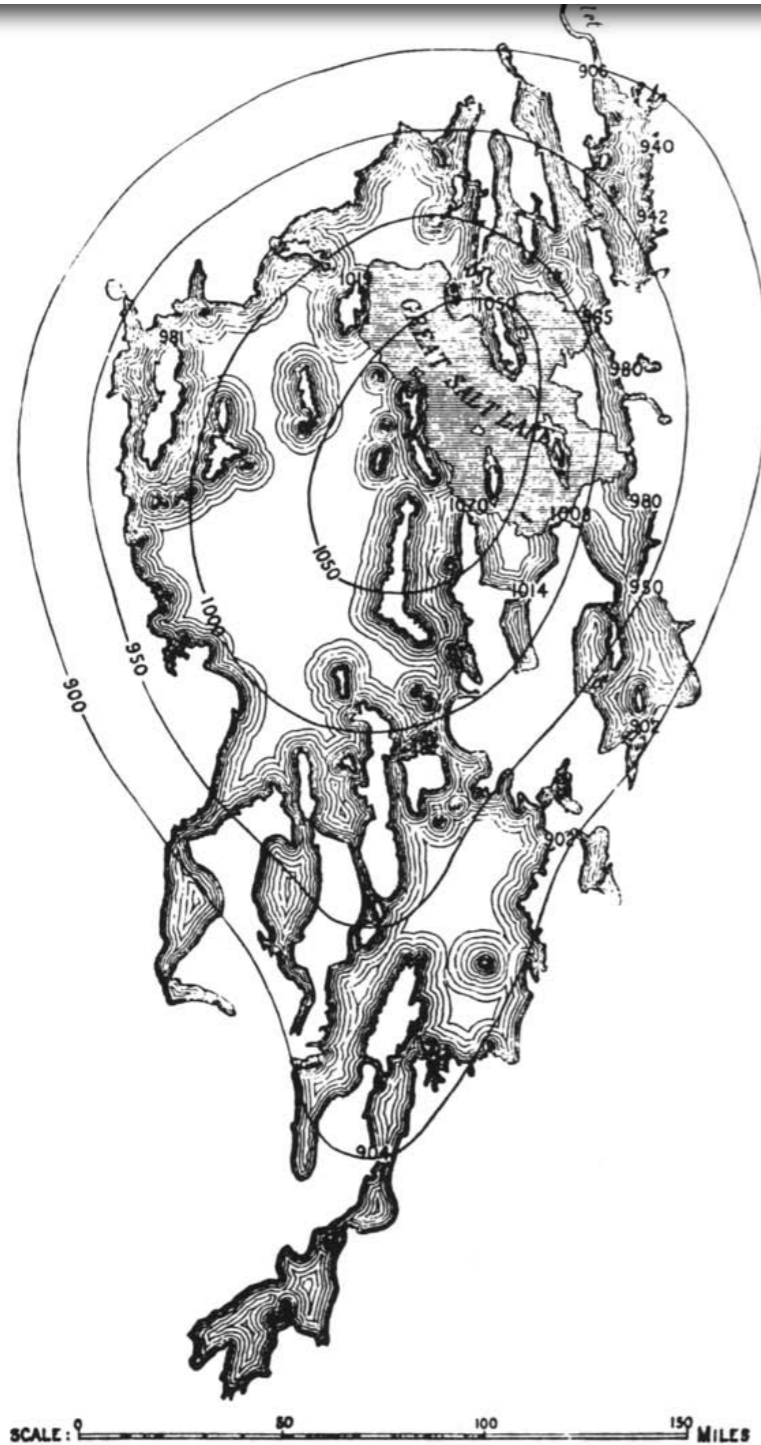

Fig. 3. Gilbert's (1890a) contour map of warped Lake Bonneville shorelines.

(D'après Wolf, 1993)

## La notion de «lithosphère», au sens d'une enveloppe rigide dotée d'une certaine élasticité, vient des études des mouvements verticaux

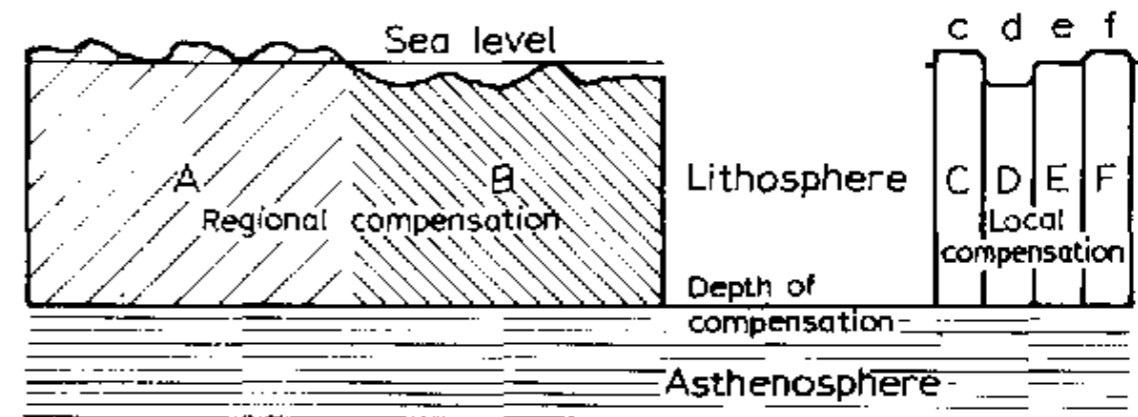

Fig. 4. Barrell's (1919b) conception of *regional* isostatic equilibrium versus conventional conception of *local* isostatic equilibrium.

En 1914 Joseph Barrell introduit la notion d'asthénosphère qu'il oppose à la lithosphère rigide. L'asthénosphère est capable de se déformer plastiquement pour effectuer les ajustements isostatiques.

La notion de «lithosphère», au sens d'une enveloppe rigide dotée d'une certaine élasticité, vient des études des mouvements verticaux

Ce type d'analyse est étendu au cas des réajustements post-glaciaires (Nansen, 1921; Daly, 1934)

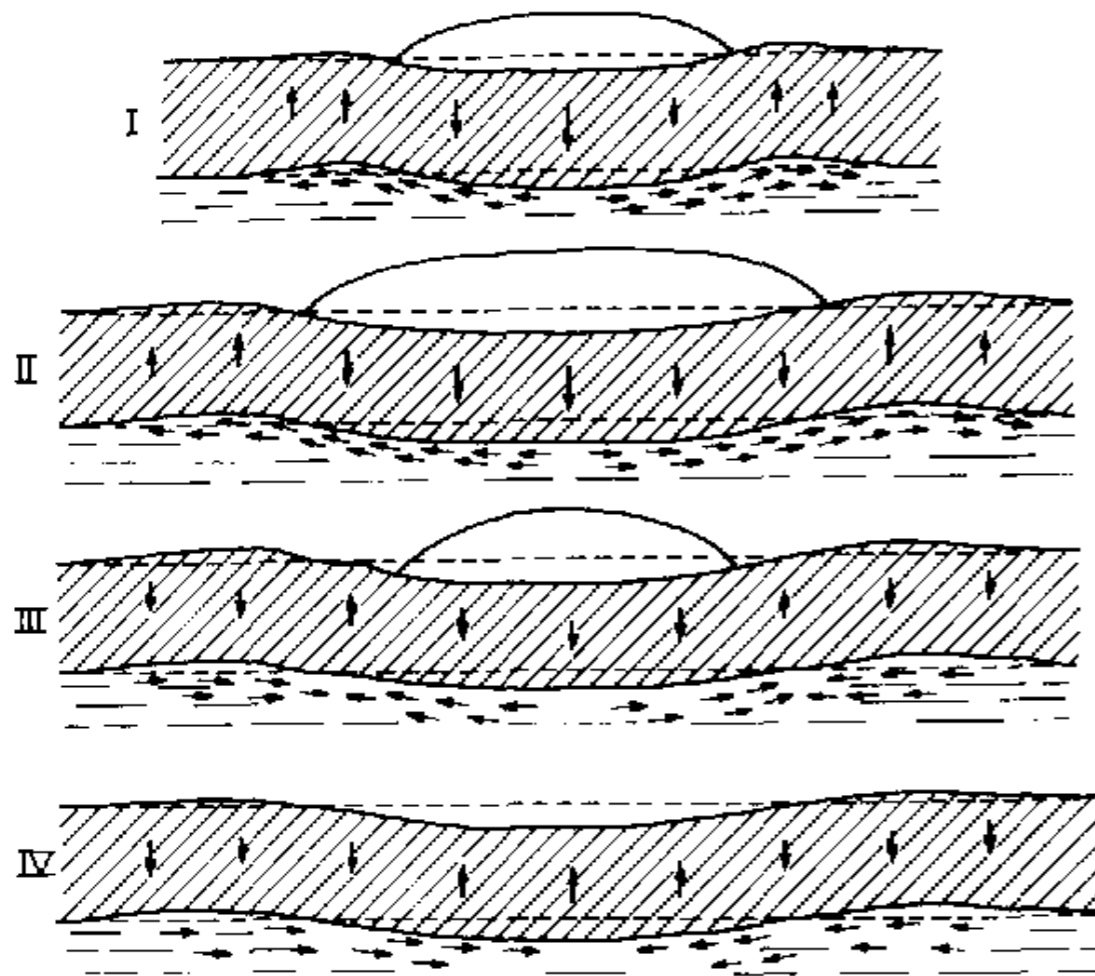

Fig. 5. Nansen's (1921) illustration of depression of crust due to ice-sheet. Note retarded response of crust and substratum.

(D'après Wolf, 1993)

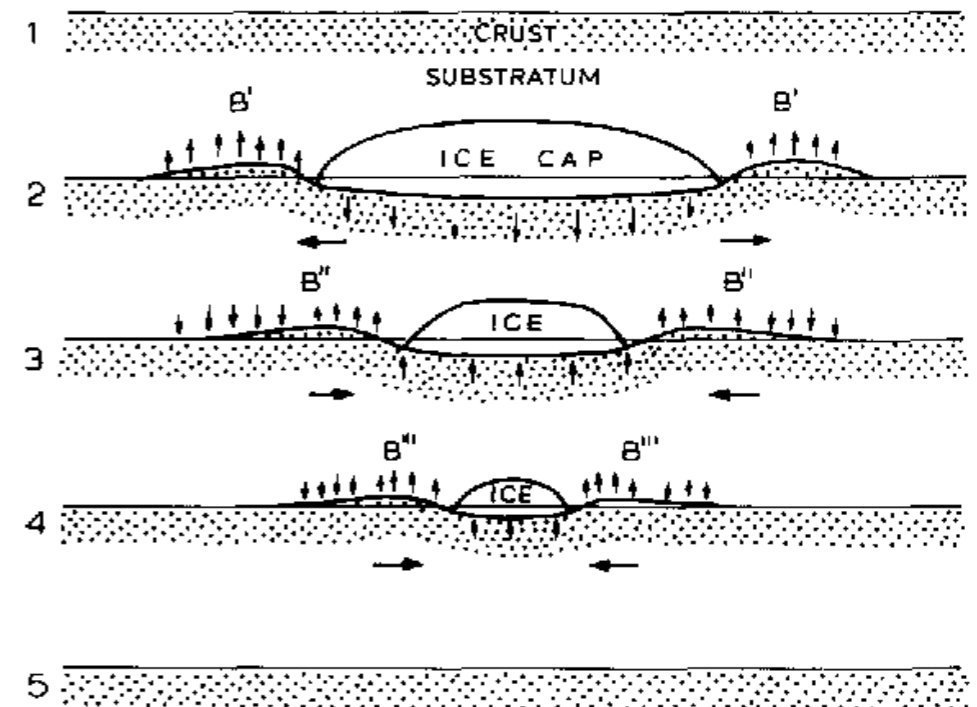

Fig. 6. Daly's (1934) illustration of *bulge hypothesis* of isostatic adjustment. Note movement of peripheral bulge.



**La notion de «lithosphère», au sens d'une enveloppe rigide dotée d'une certaine élasticité, vient des études des mouvements verticaux**

Ce type d'analyse est étendu au cas des réajustements post-glaciaires (Nansen, 1921; Daly, 1934)

Les travaux plus récents ont permis d'estimer la viscosités respectives de la lithosphère ( $\sim 10^{21}$  Pa.s) et de l'asthénosphère (1-2 ordres de grandeur plus faible) ainsi que les épaisseurs de la lithosphère (de 50 à plus de 200 km)

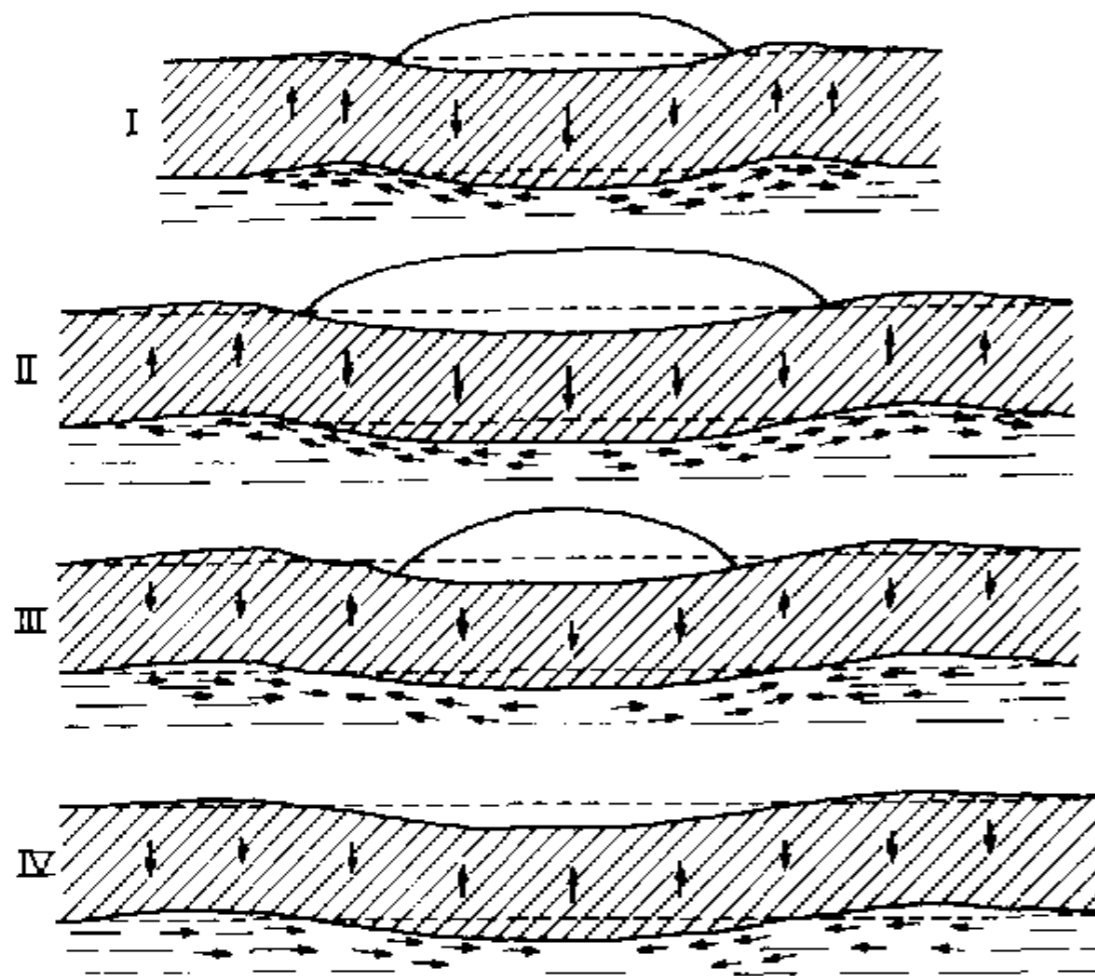

Fig. 5. Nansen's (1921) illustration of depression of crust due to ice-sheet. Note retarded response of crust and substratum.

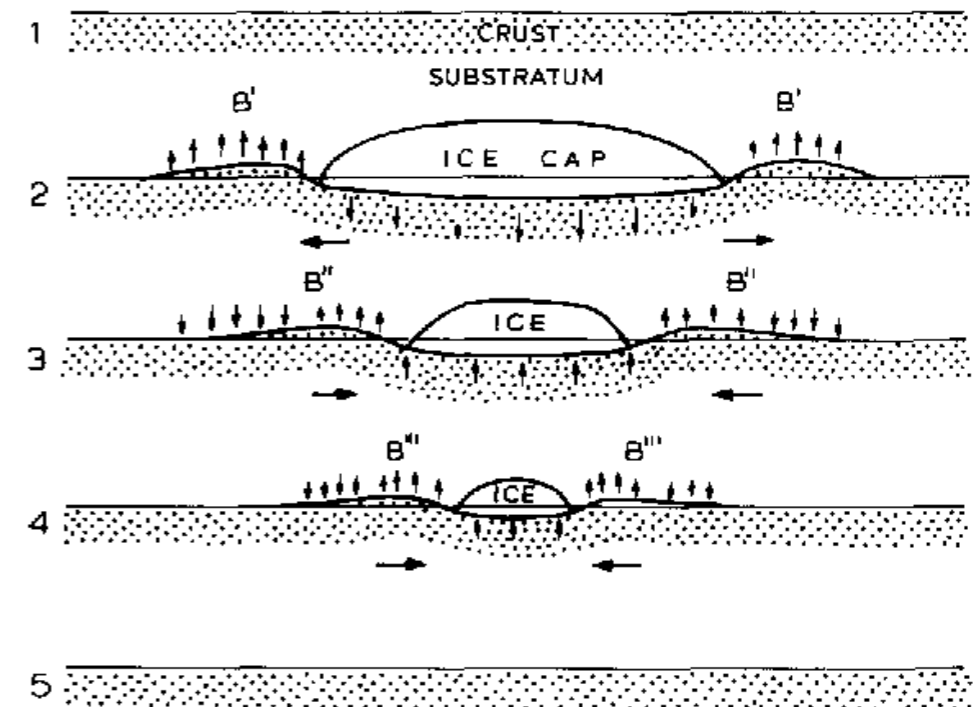
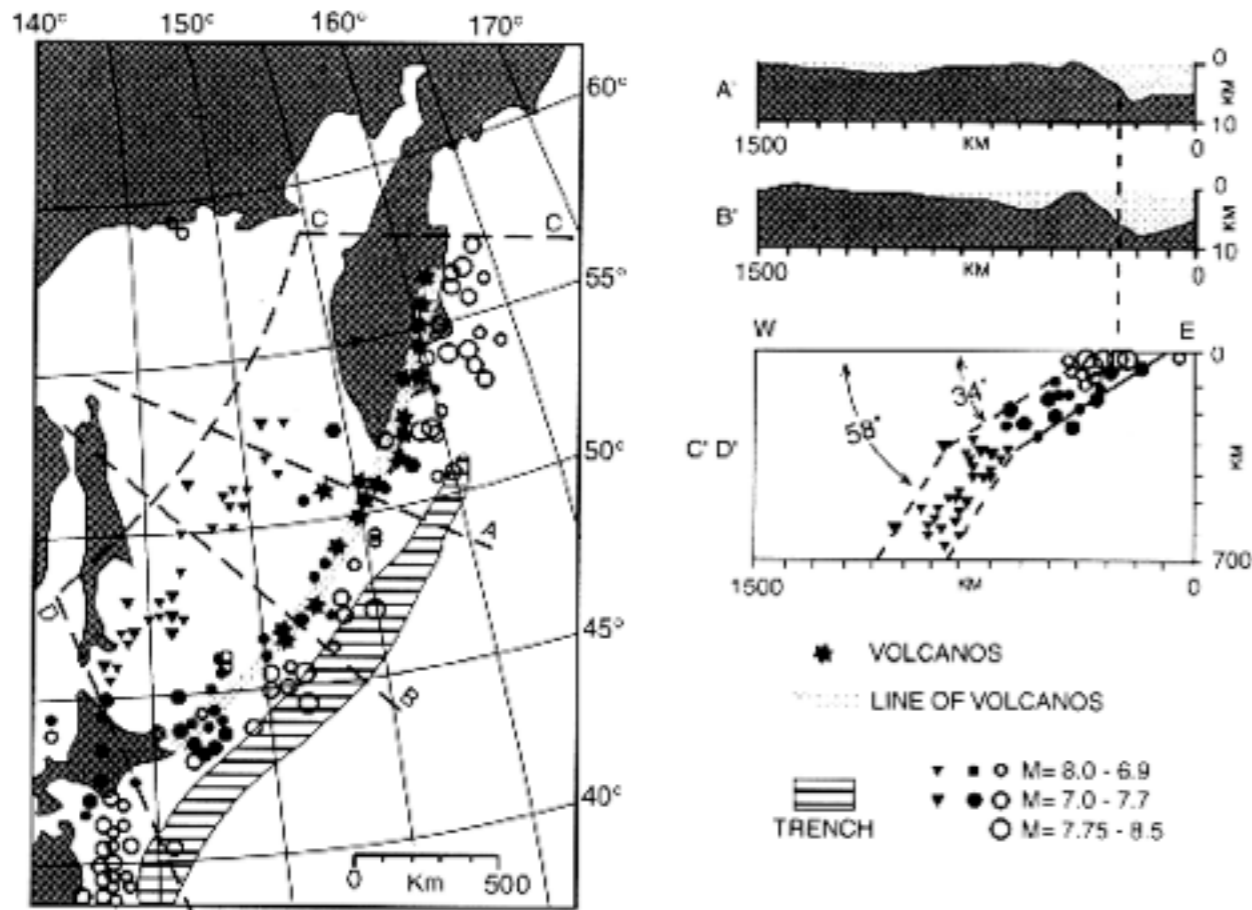

Fig. 6. Daly's (1934) illustration of *bulge hypothesis* of isostatic adjustment. Note movement of peripheral bulge.

(D'après Wolf, 1993)

# Une autre approche de la lithosphère au travers de la subduction



Distribution of Earthquake Focus in the Japanese Islands and their Neighbourhood.

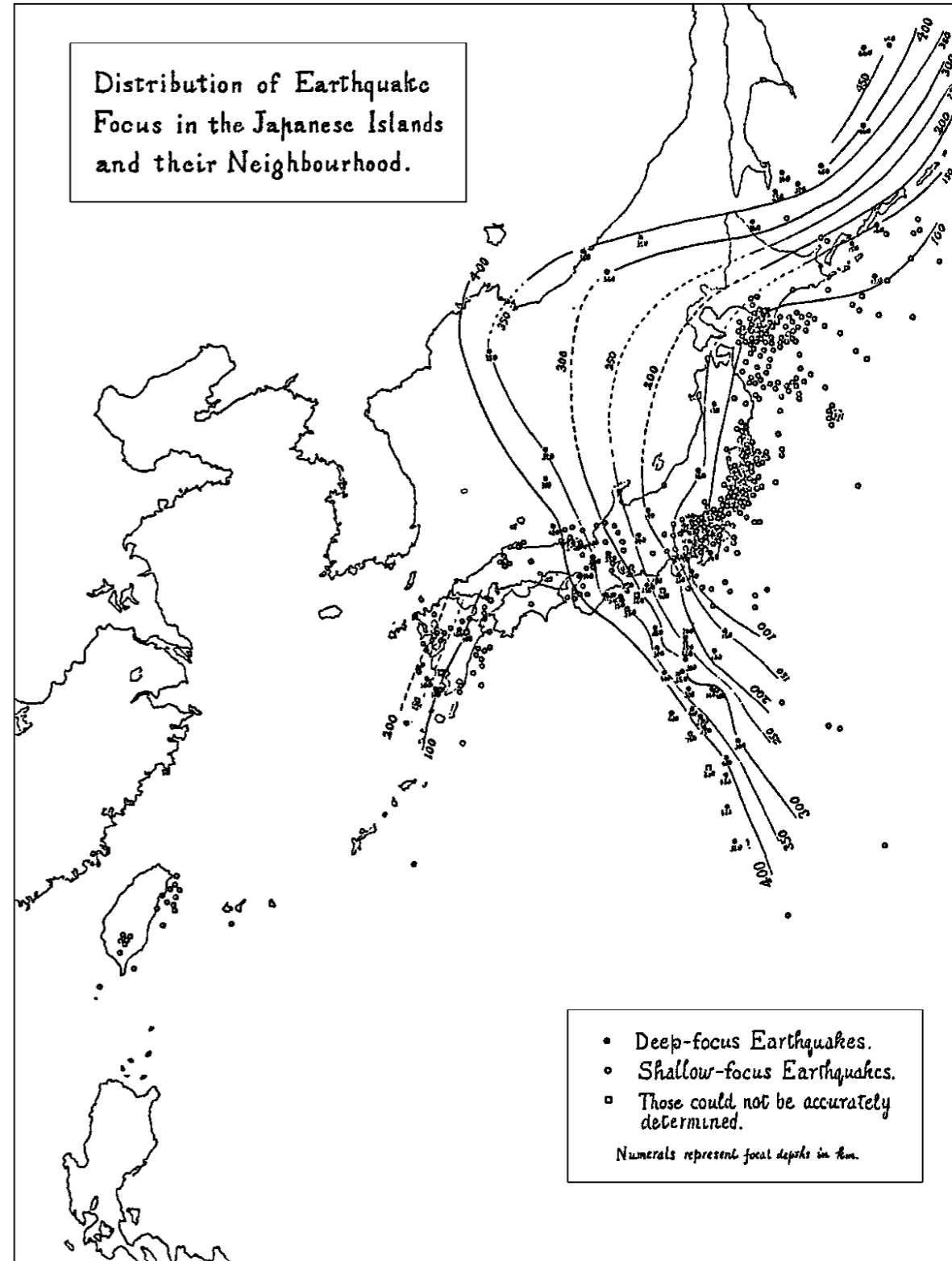

- Deep-focus Earthquakes.
- Shallow-focus Earthquakes.
- ◻ Those could not be accurately determined.

Numerals represent focal depths in Km.

Benioff, 1955

Wadati, 1935



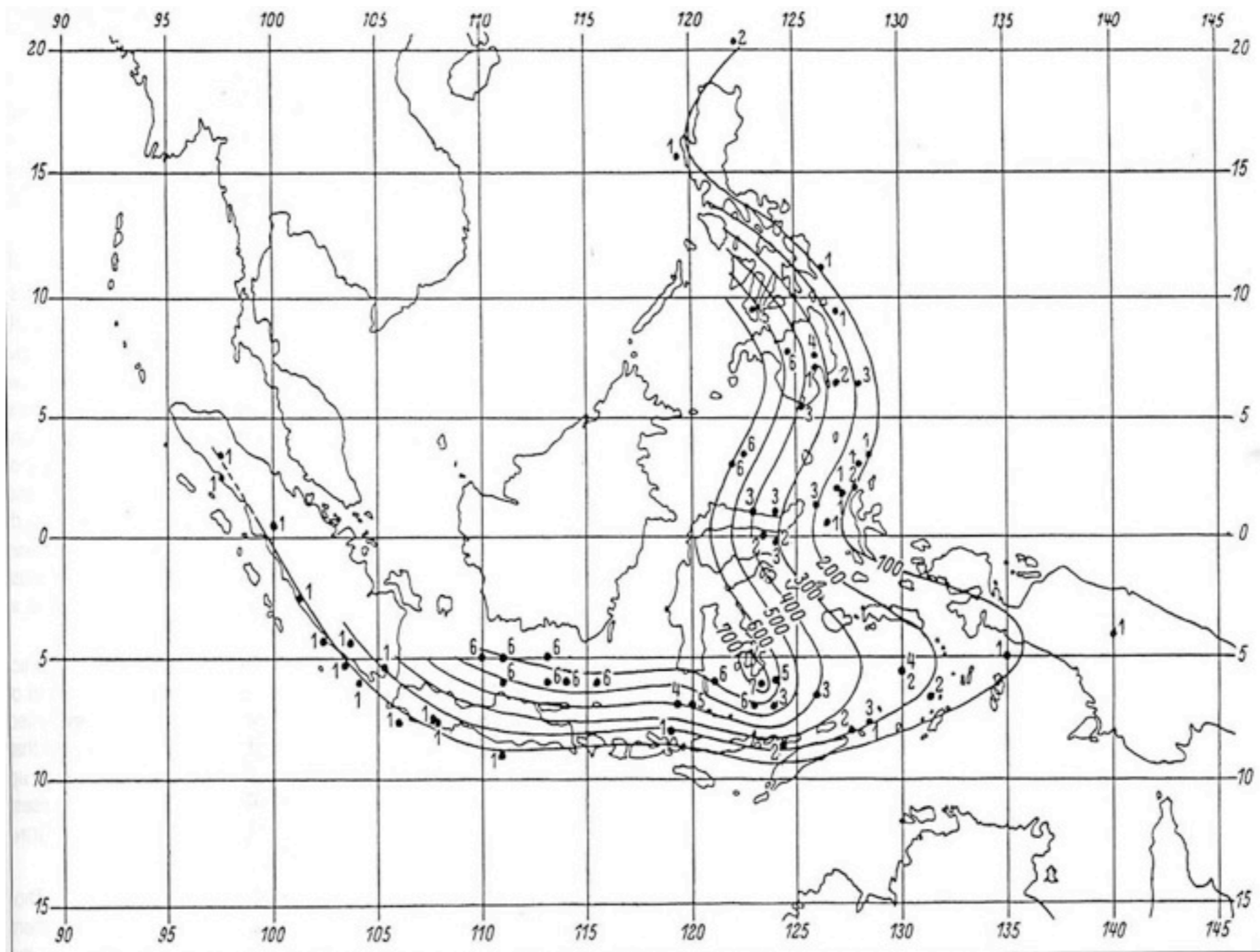

**H. P. Berlage, 1937:** Les isobathes des tremblements de terre de l'Asie du sud-est.  
(repris du cours de C. Sengör au Collège de France en 2005)

# Deep Earthquake Zones, Anomalous Structures in the Upper Mantle, and the Lithosphere<sup>1</sup>

JACK OLIVER AND BRYAN ISACKS

Lamont Geological Observatory, Columbia University  
Palisades, New York 10964

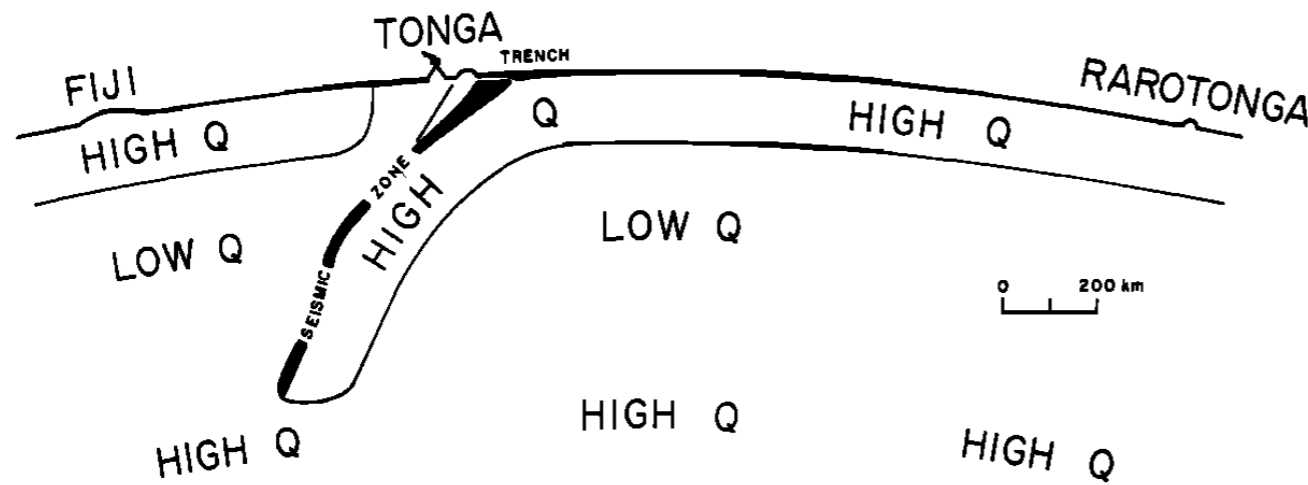

Fig. 13. Hypothetical section through Fiji, Tonga, and Rarotonga based on data of this paper. Boundaries between high  $Q$  and low  $Q$  zones are not well determined but can be taken as a first approximation.

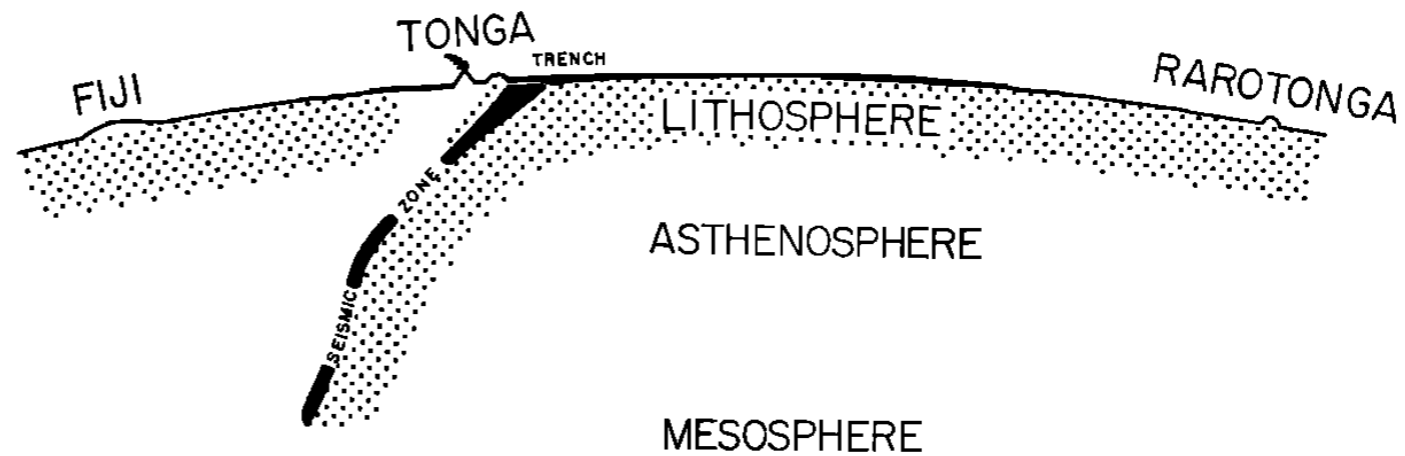

Fig. 14. Hypothetical section through Fiji, Tonga, and Rarotonga, assuming  $Q$  correlates with strength. The lithosphere and mesosphere are zones of significant strength, and the asthenosphere is a zone of vanishing strength on appropriate time scale. The terminology is that of *Daly* [1940].



# Deep Earthquake Zones, Anomalous Structures in the Upper Mantle, and the Lithosphere<sup>1</sup>

JACK OLIVER AND BRYAN ISACKS

Lamont Geological Observatory, Columbia University  
Palisades, New York 10964

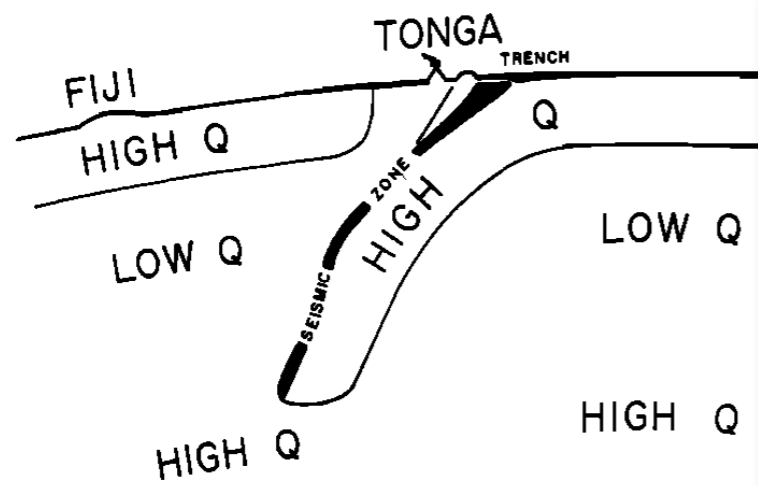

Fig. 13. Hypothetical section through Fiji, Tonga paper. Boundaries between high  $Q$  and low  $Q$  zone taken as a first approximation.

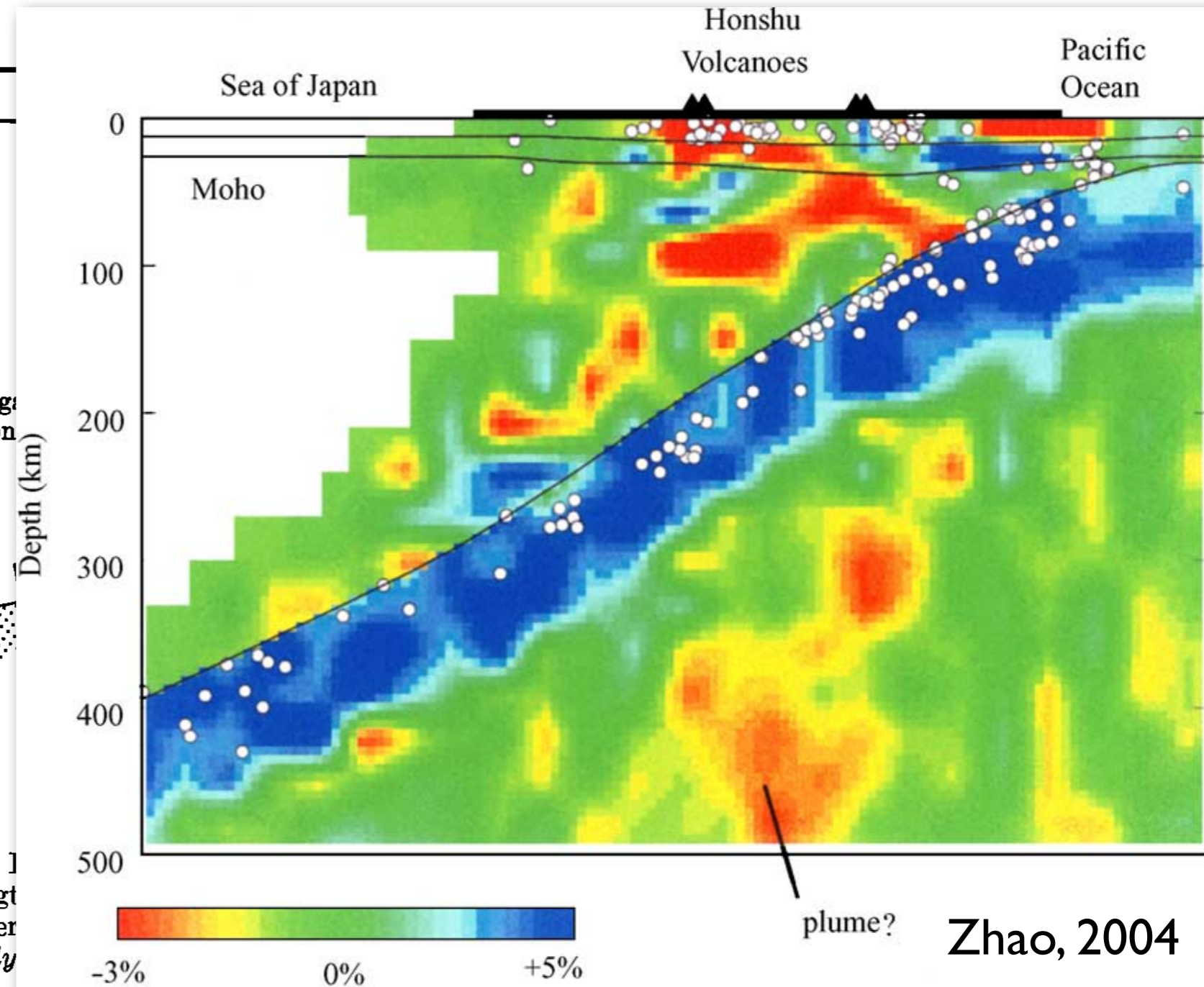
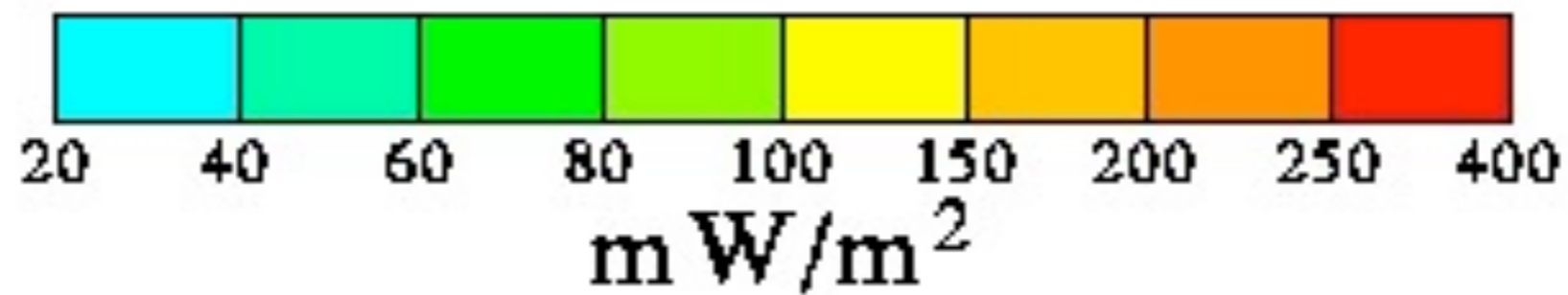
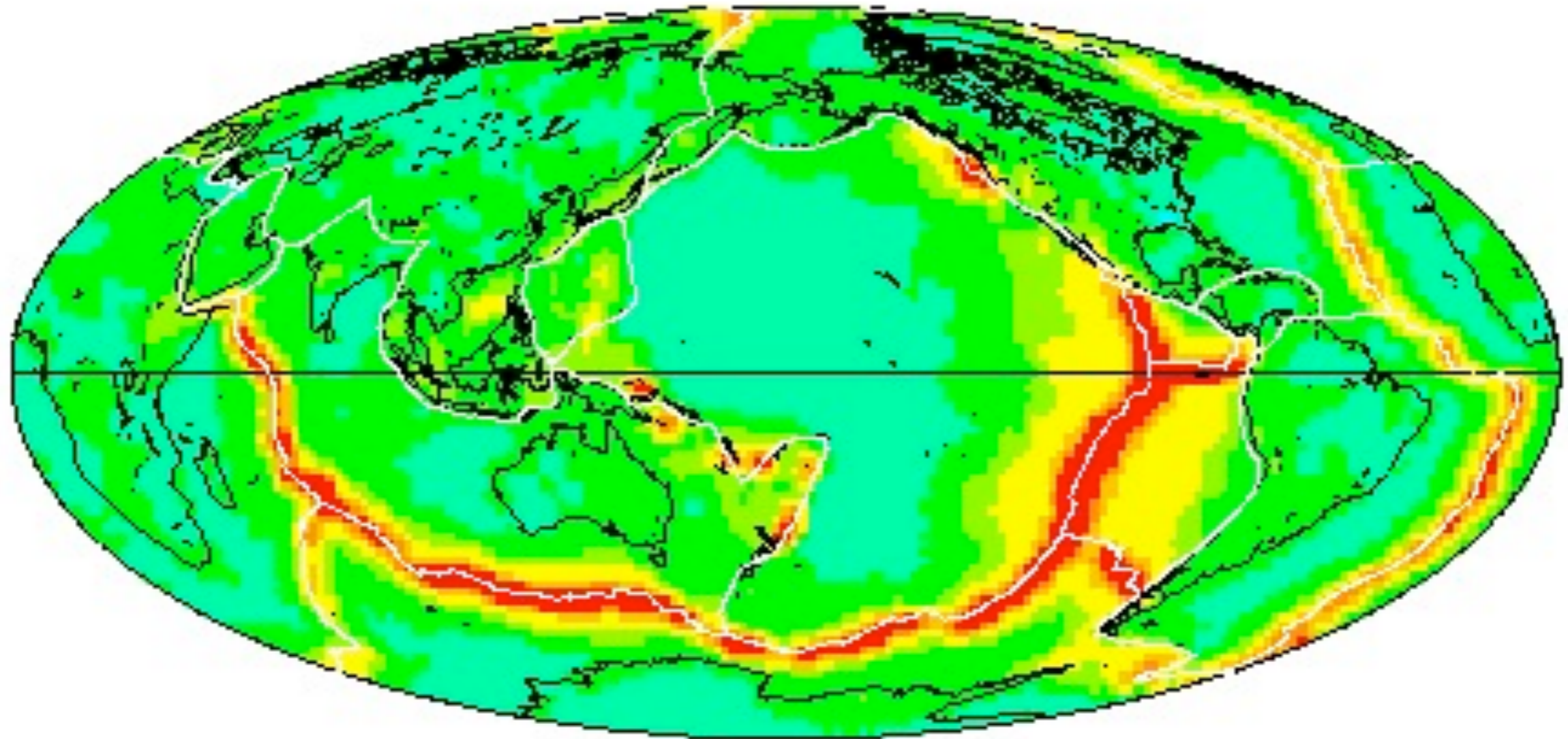

Fig. 14. 1 with strengt asthenospher that of *Daly*

Zhao, 2004

**Une dernière approche de la lithosphère  
au travers du flux de chaleur**





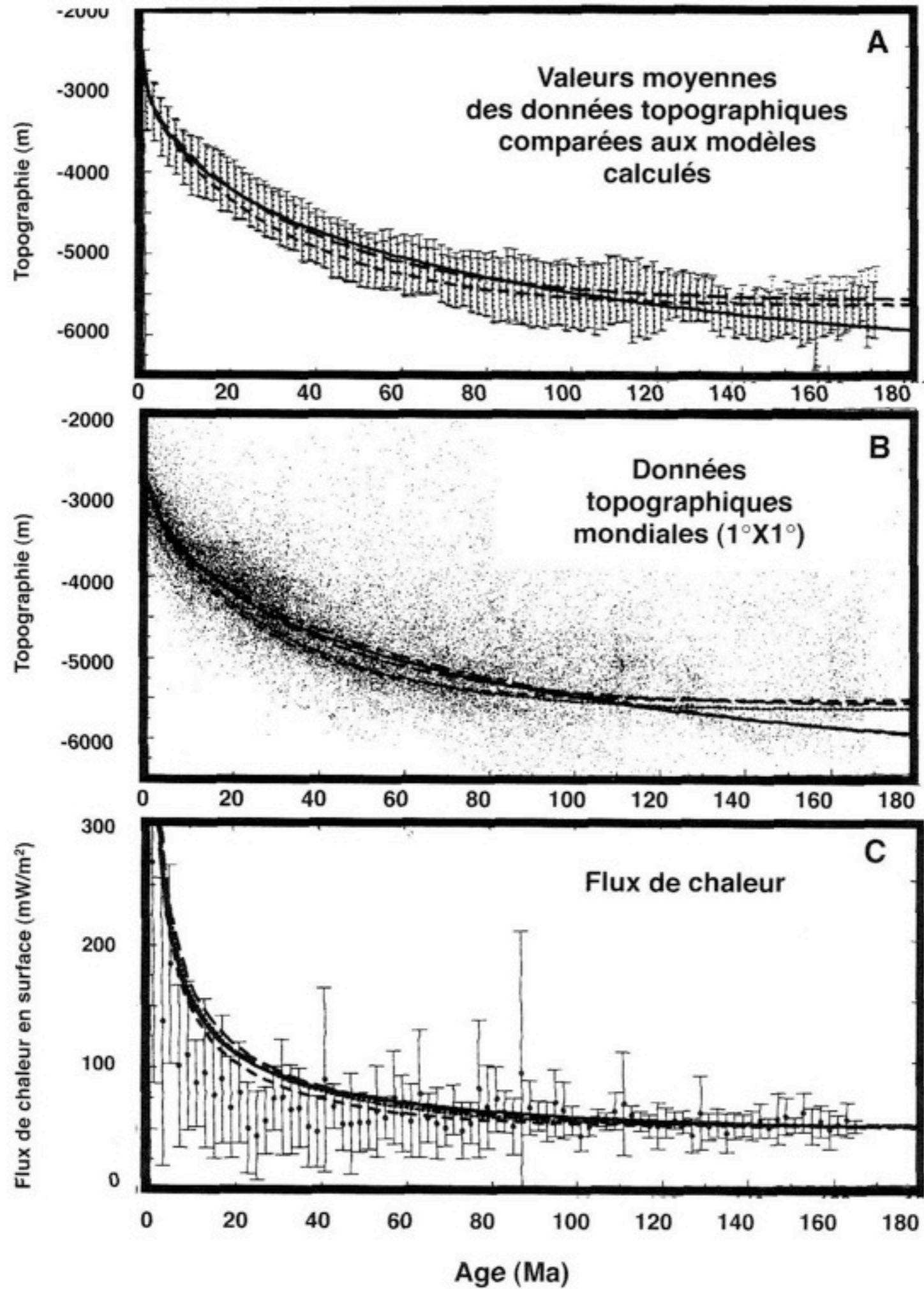

ride mdio-oanique

plaine abyssale

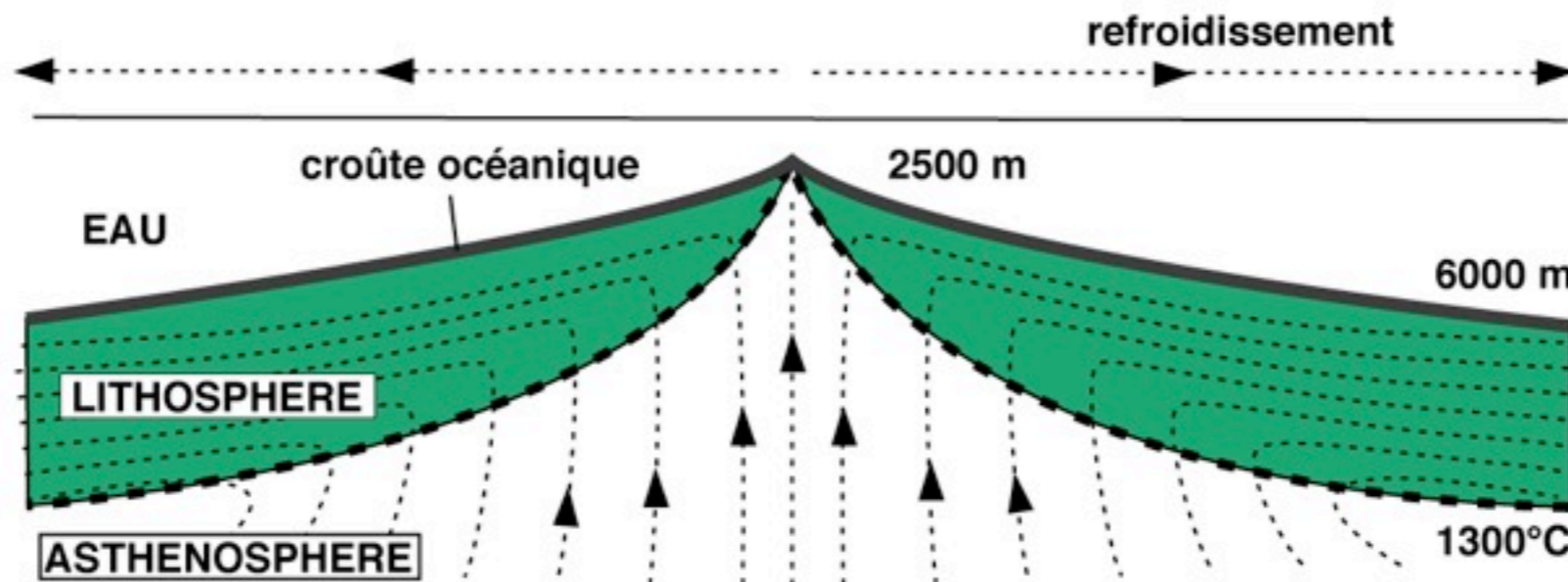

ride rapide (Pacifique)

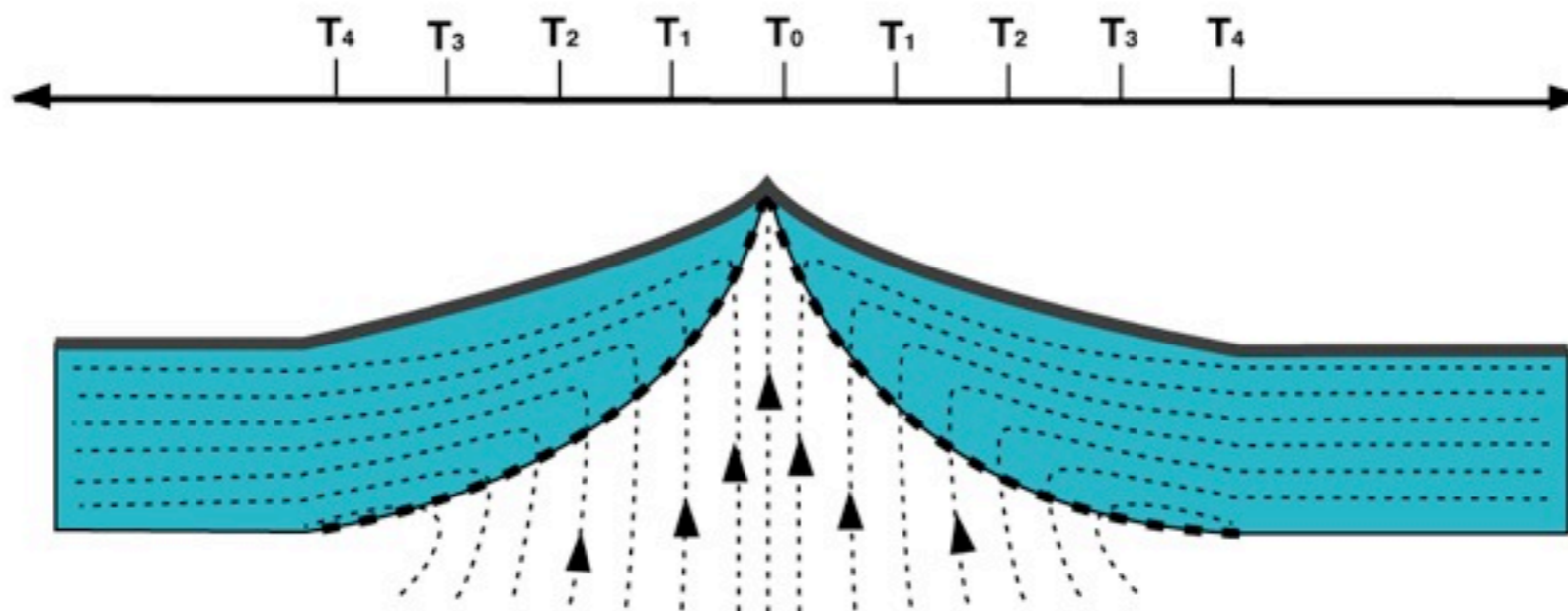

ride lente (Atlantique)

T<sub>4</sub> T<sub>3</sub> T<sub>2</sub> T<sub>1</sub> T<sub>0</sub> T<sub>1</sub> T<sub>2</sub> T<sub>3</sub> T<sub>4</sub>





## **Un premier modèle global: une lithosphère découpée en plaques rigides**

A la fin des années soixante, la géométrie des failles transformantes océaniques permet de proposer un modèle en plaques rigides.

Des travaux complémentaires parachèvent l'établissement de la théorie de la tectonique des plaques en montrant que les mouvements divergents (dorsales), décrochants (failles transformantes) et convergents (zones de subduction) sont cohérents avec ce modèle géométrique.

Des alignements volcaniques, situés en domaine océanique ou continental, dont la position ne correspond pas à des frontières de plaques, sont la trace du déplacement de plaques lithosphériques au dessus d'un point chaud fixe, en première approximation, dans le manteau.

# A NEW CLASS OF FAULTS AND THEIR BEARING ON CONTINENTAL DRIFT

By PROF. J. TUZO WILSON, O.B.E.  
Institute of Earth Sciences, University of Toronto

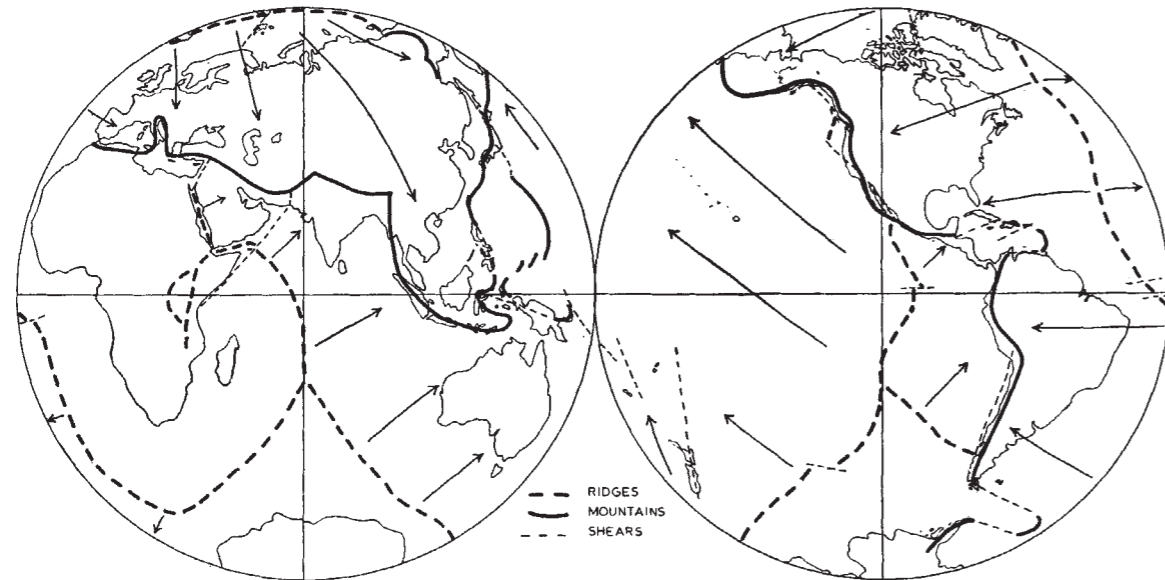

Fig. 1. Sketch map illustrating the present network of mobile belts, comprising the active primary mountains and island arcs in compression (solid lines), active transform faults in horizontal shear (light dashed lines) and active mid-ocean ridges in tension (heavy dashed lines)

**J.T. Wilson introduit la notion de faille transformante et invente la tectonique des plaques**

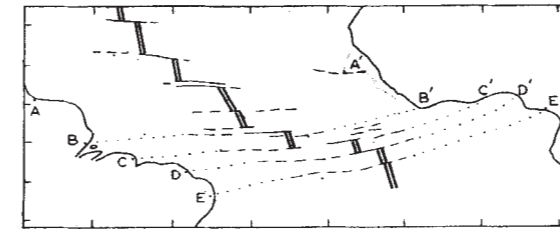

Fig. 7. Sketch (after Krause and Heezen *et al.*) showing how the Mid-Atlantic ridge is offset to the left by active transform faults which have dextral motions if the rift is expanding (see Fig. 4a). ||, Mid-ocean ridge; —, active fault; - - -, inactive fault trace; . . . . , hypothetical extension of fault

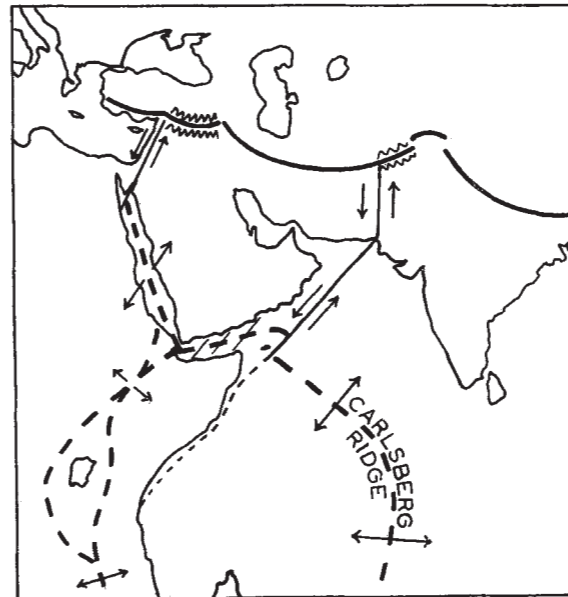

Fig. 8. Sketch illustrating the end of the Carlsberg mid-ocean ridge by a large transform fault (ridge-convex arc type) extending to the Hindu Kush, the end of the rift up the Red Sea by a similar transform fault extending into Turkey and the still younger East African rifts

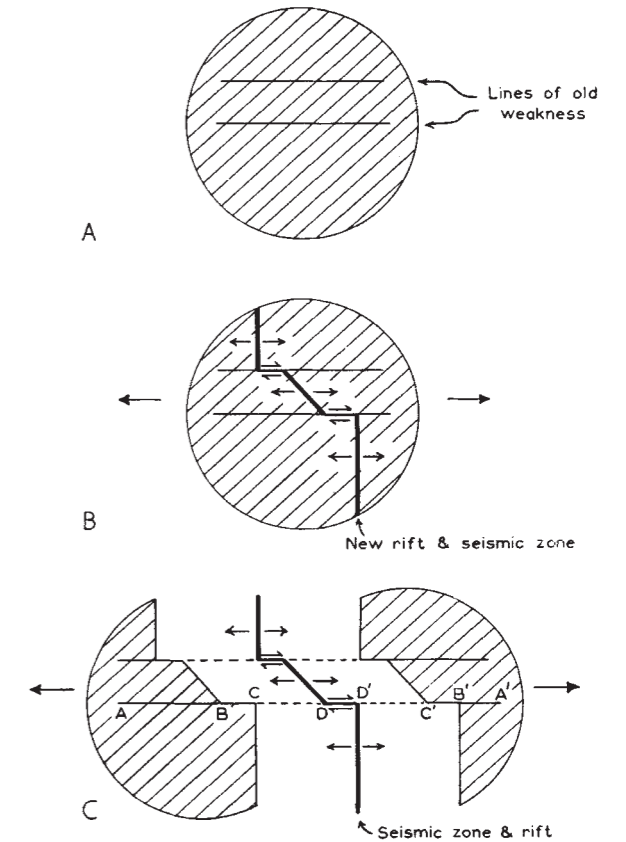

Fig. 6. Diagram illustrating three stages in the rifting of a continent into two parts (for example, South America and Africa). There will be seismic activity along the heavy lines only



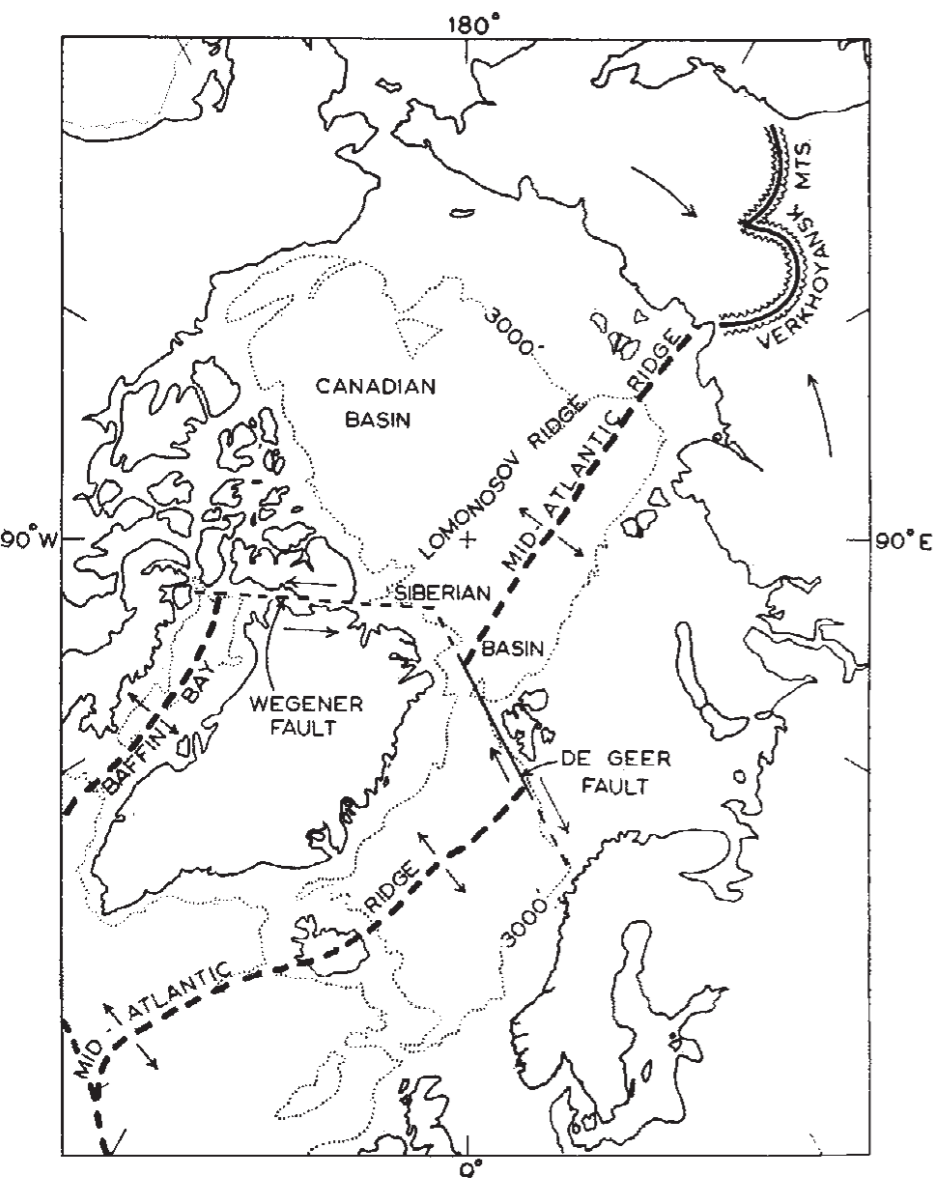

Fig. 5. Sketch map of the termination of the Mid-Atlantic ridge by two large transform faults (Wegener and De Geer faults) and by transformation into the Verkhoyansk Mountains

Wilson, 1965

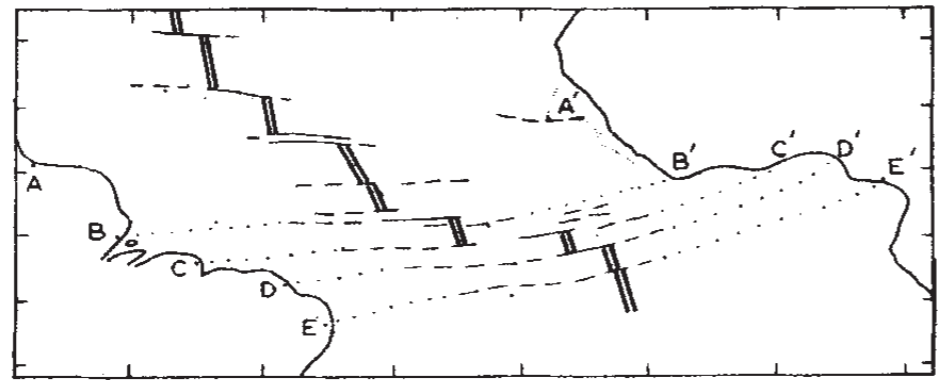

Fig. 7. Sketch (after Krause and Heezen *et al.*) showing how the Mid-Atlantic ridge is offset to the left by active transform faults which have dextral motions if the rift is expanding (see Fig. 4a). ||, Mid-ocean ridge; —, active fault; ---, inactive fault trace; . . . , hypothetical extension of fault

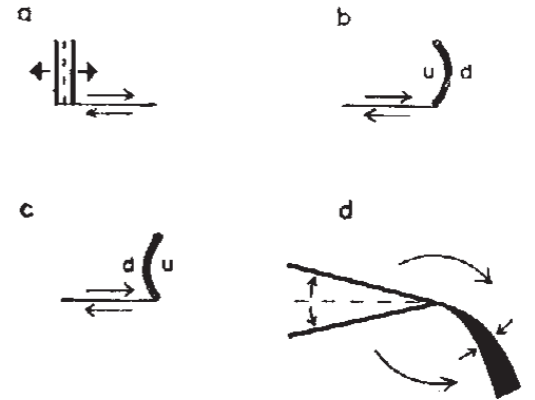

Fig. 2. Diagram illustrating the four possible right-hand transforms. a, Ridge to dextral half-shear; b, dextral half-shear to concave arc; c, dextral half-shear to convex arc; d, ridge to right-hand arc

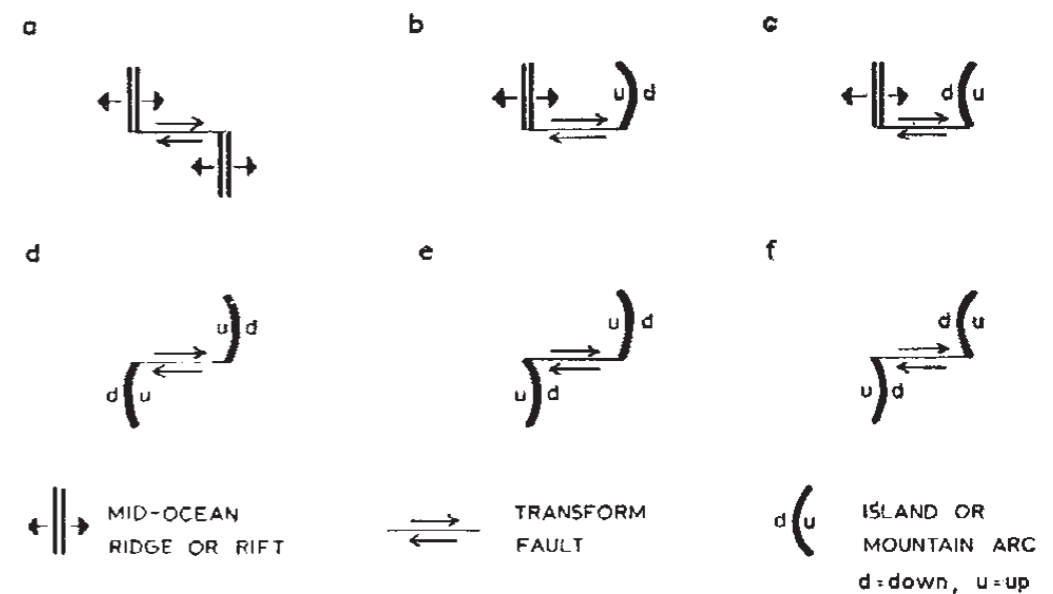

Fig. 3. Diagram illustrating the six possible types of dextral transform faults. a, Ridge to ridge type; b, ridge to concave arc; c, ridge to convex arc; d, concave arc to concave arc; e, concave arc to convex arc; f, convex arc to convex arc. Note that the direction of motion in a is the reverse of that required to offset the ridge

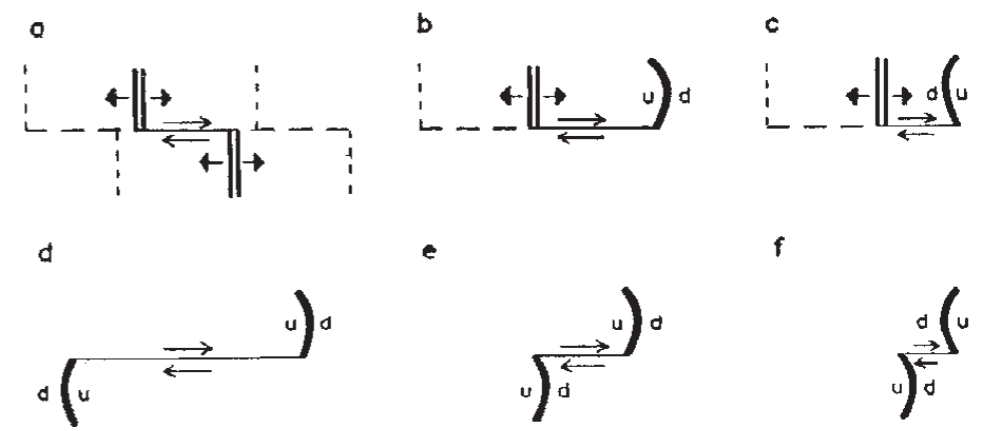

Fig. 4. Diagram illustrating the appearance of the six types of dextral transform faults shown in Fig. 3 after a period of growth. Traces of former positions now inactive, but still expressed in the topography, are shown by dashed lines

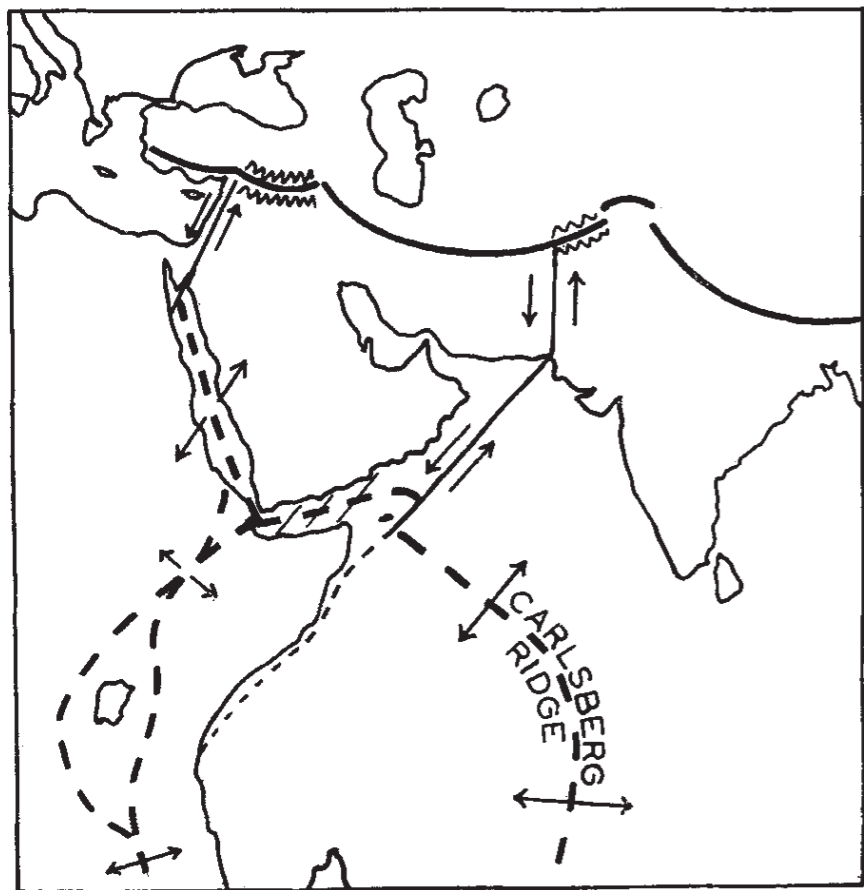

Fig. 8. Sketch illustrating the end of the Carlsberg mid-ocean ridge by a large transform fault (ridge-convex arc type) extending to the Hindu Kush, the end of the rift up the Red Sea by a similar transform fault extending into Turkey and the still younger East African rifts

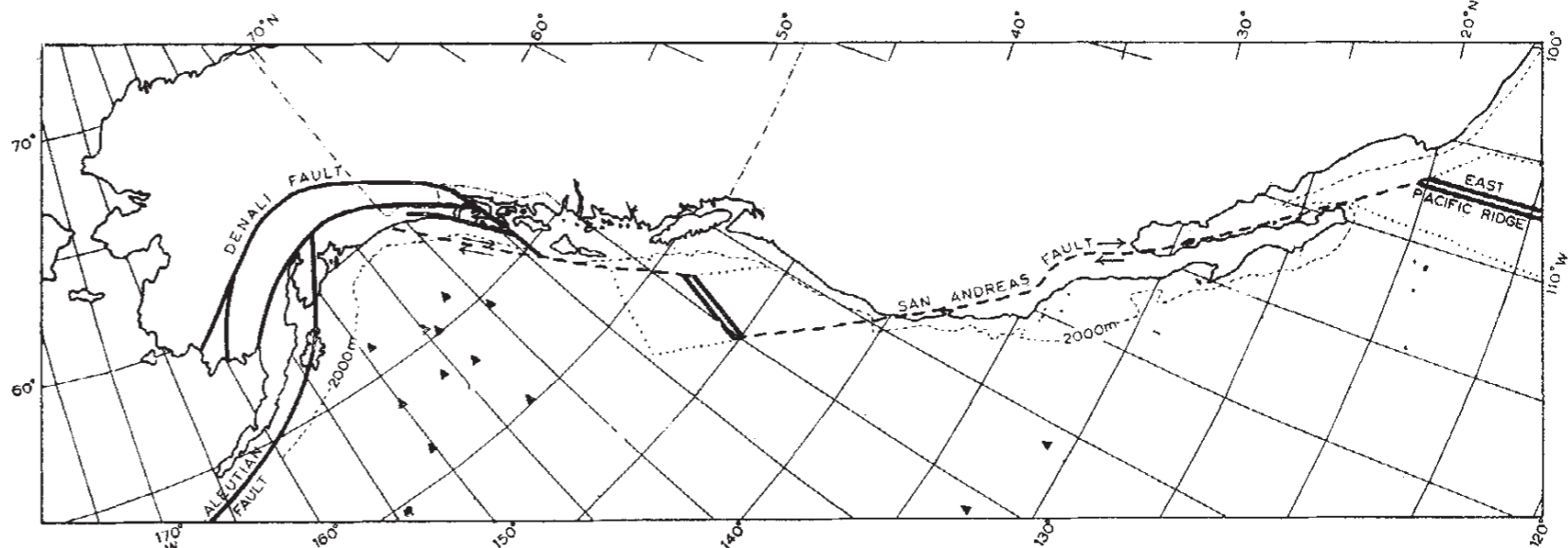

Fig. 9. Sketch map of the west coast of North America showing the approximate location of a submarine thrust fault along the Aleutian trench, the Denali faults (after St. Amand), the San Andreas and another large transform fault (after Benioff) and part of the East Pacific ridge and another mid-ocean ridge (after Menard)

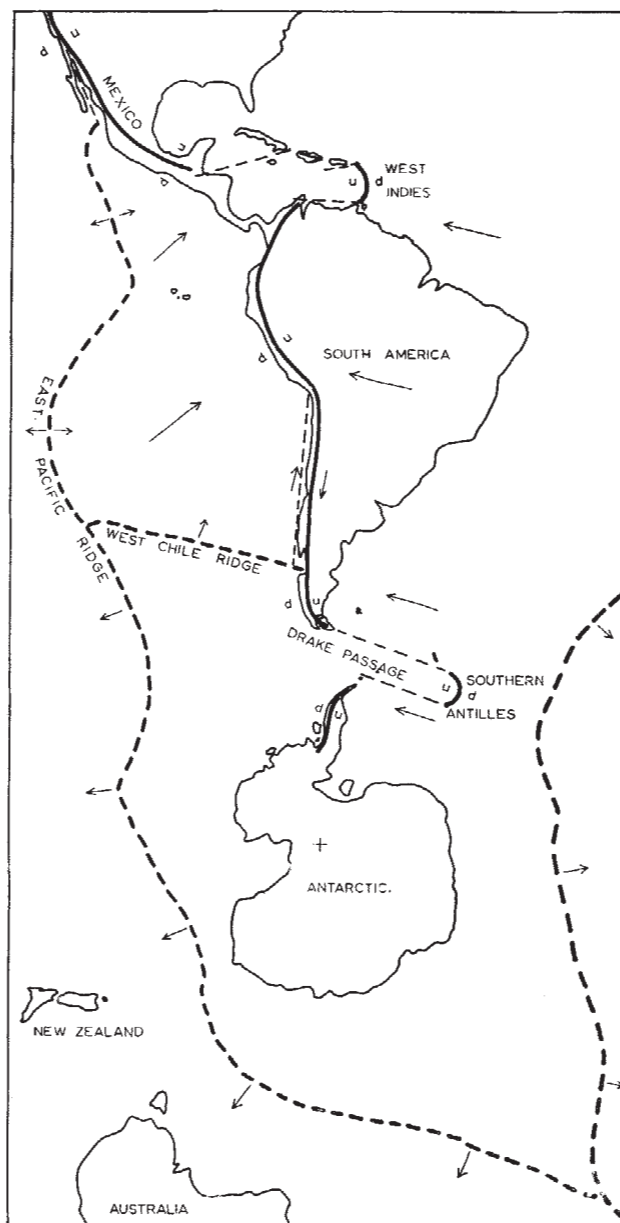

Fig. 10. Sketch map of Mexico, South America, Antarctica and part of the mid-ocean ridge system (heavy dashed lines) illustrating that the great loop of the ridge about Antarctica can only grow by increasing in diameter. Transform faults are shown by light dashed lines

Wilson, 1965



cinématique à deux plaques

*Quelles données ?*

By J. P. ROTHÉ

*Professeur à l'Université de Strasbourg, Directeur du Bureau international de Séismologie*

The distribution of earthquake epicentres in the Atlantic and Indian Oceans is discussed; numerous new epicentres are listed. It is shown that the line of epicentres following the mid-Atlantic Ridge is continued round the Cape of Good Hope and joins the similar line marking the central ridge of the Indian Ocean. It seems, therefore, that these two ridges are related structures.

Source: *Proceedings of the Royal Society of London. Series A, Mathematical and Physical Sciences*, Vol. 222, No. 1150, A Discussion on the Floor of the Atlantic Ocean (Mar. 18, 1954), pp. 387-397

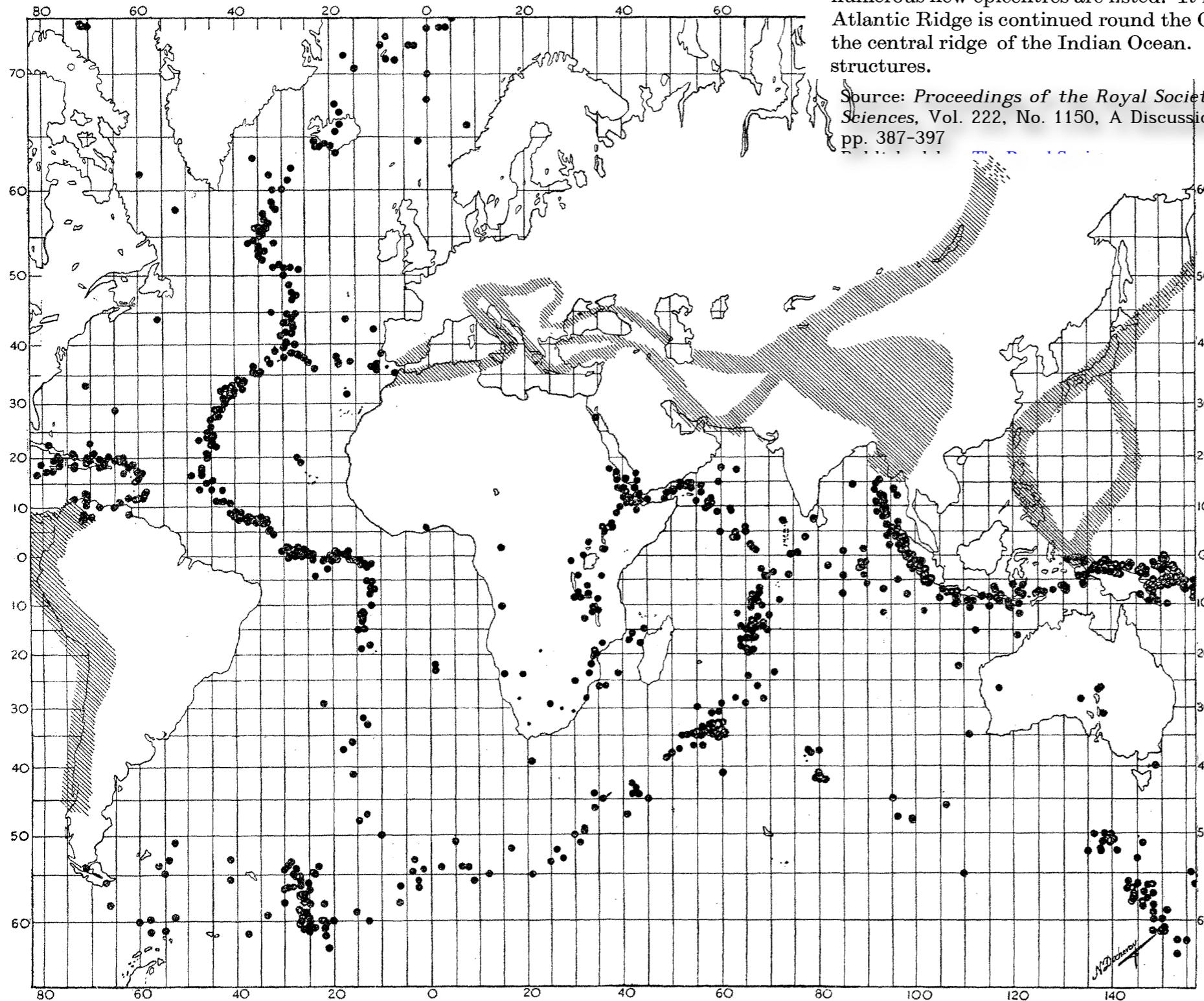
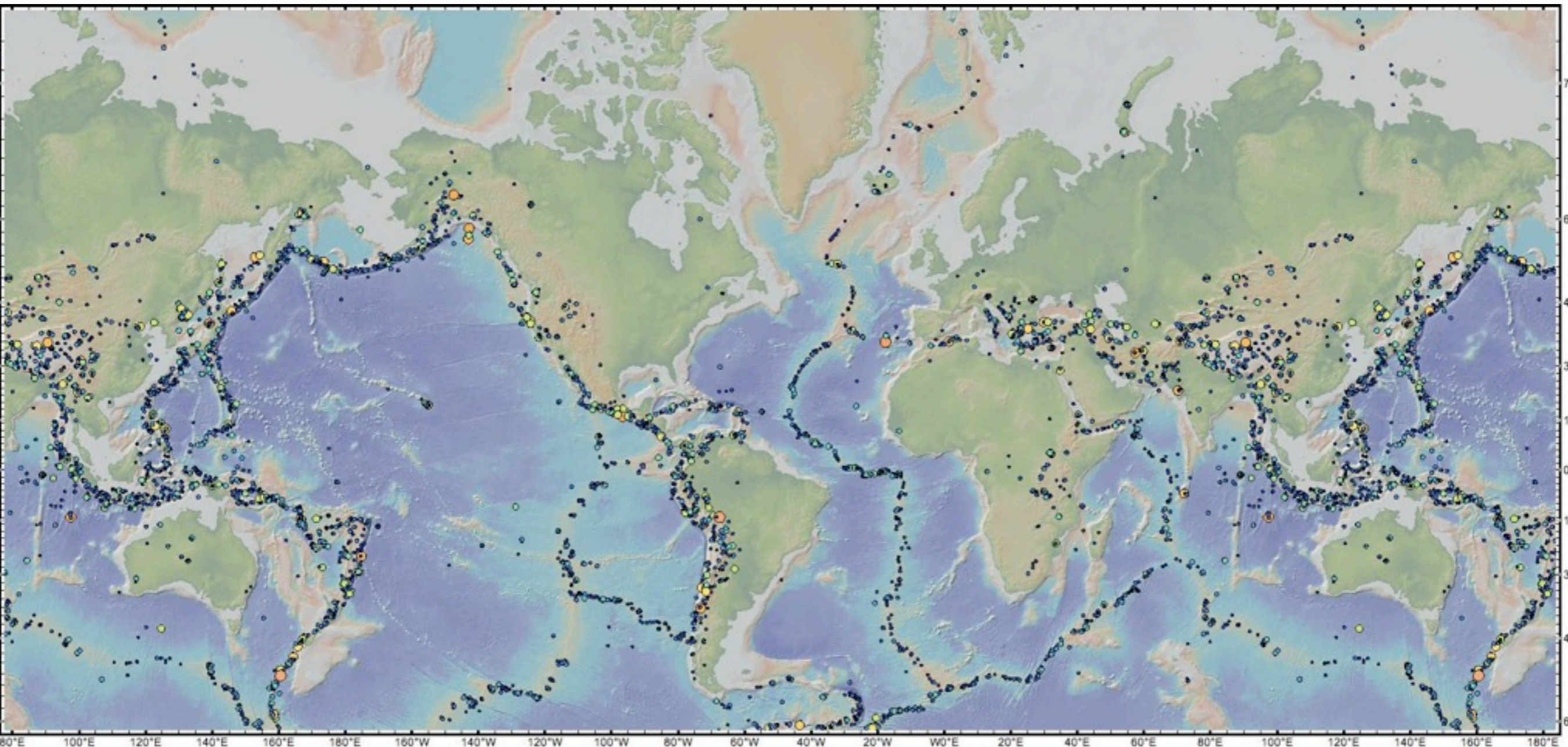

FIGURE 27. Epicentres des séismes de la zone médiane indo-atlantique et des régions voisines; les zones hachurées marquent l'emplacement des autres grandes zones séismiques.



# Les limites de plaques



la sismicité est localisée le long de ceintures étroites  
(ici les séismes de magnitude  $> 5.5$ )



# Les limites de plaques

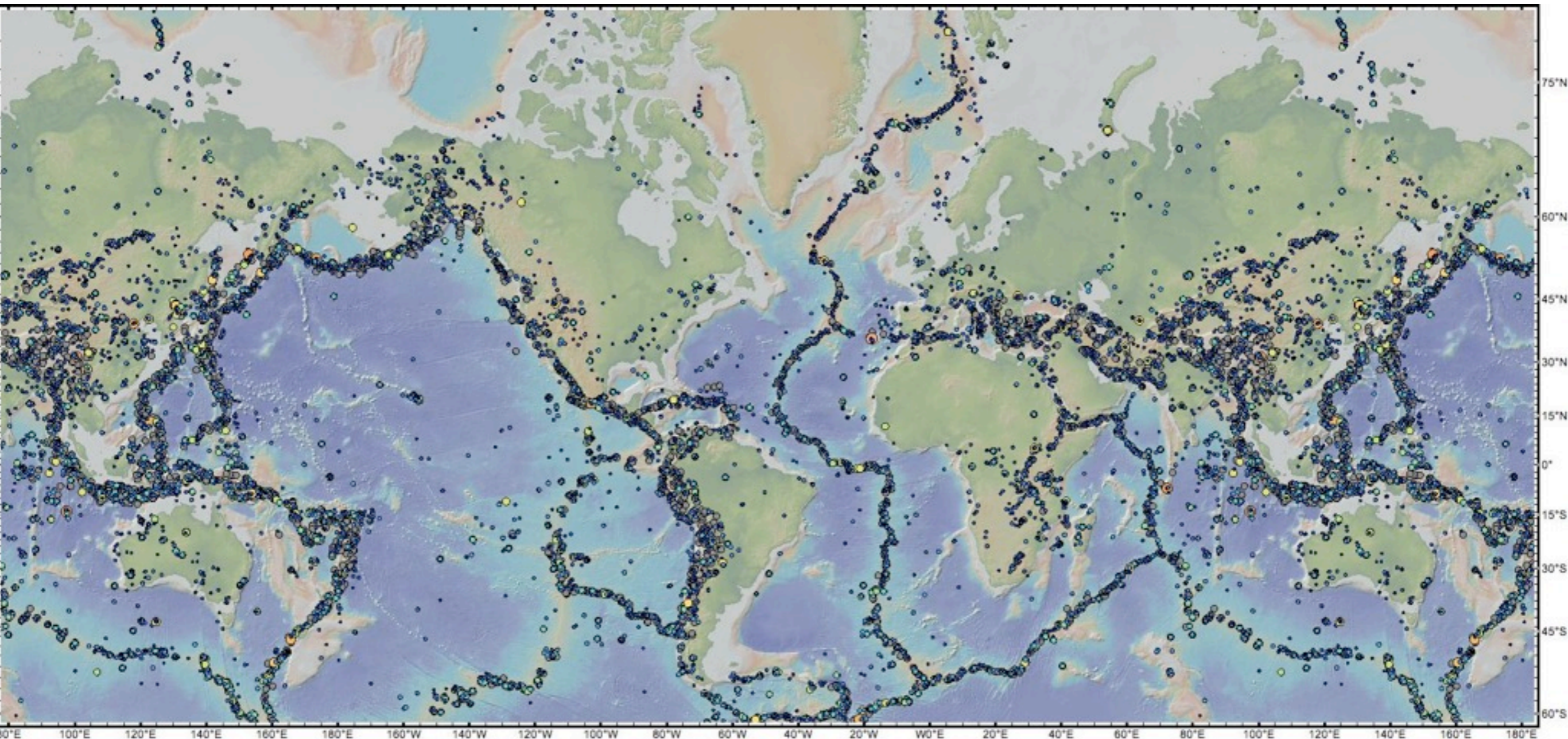

la sismicité est localisée le long de ceintures étroites  
(ici les séismes de magnitude  $> 4.5$ )



# Les vitesses relatives: les anomalies magnétiques

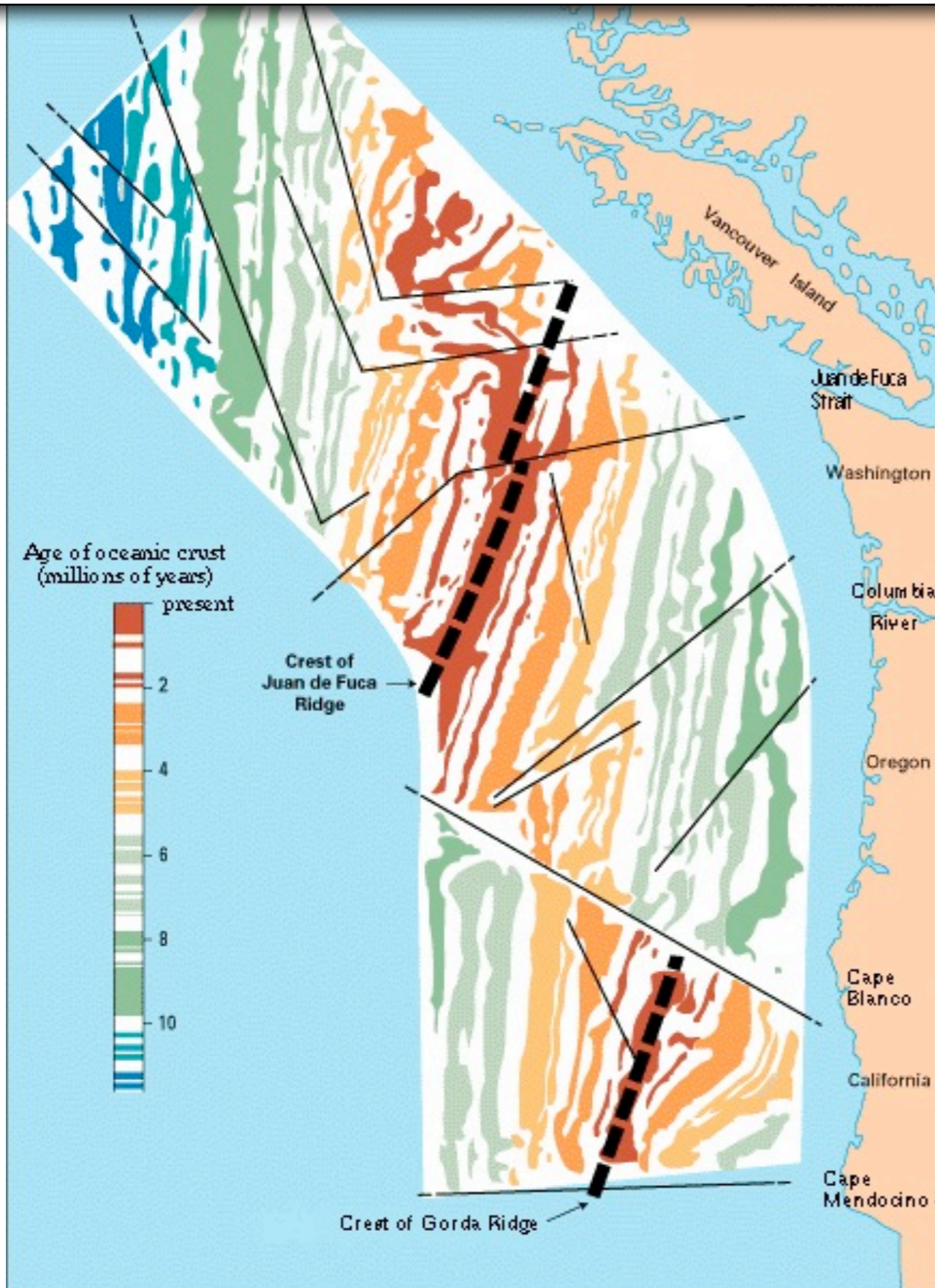



# Les directions des mouvements relatifs: les mécanismes au foyer des séismes

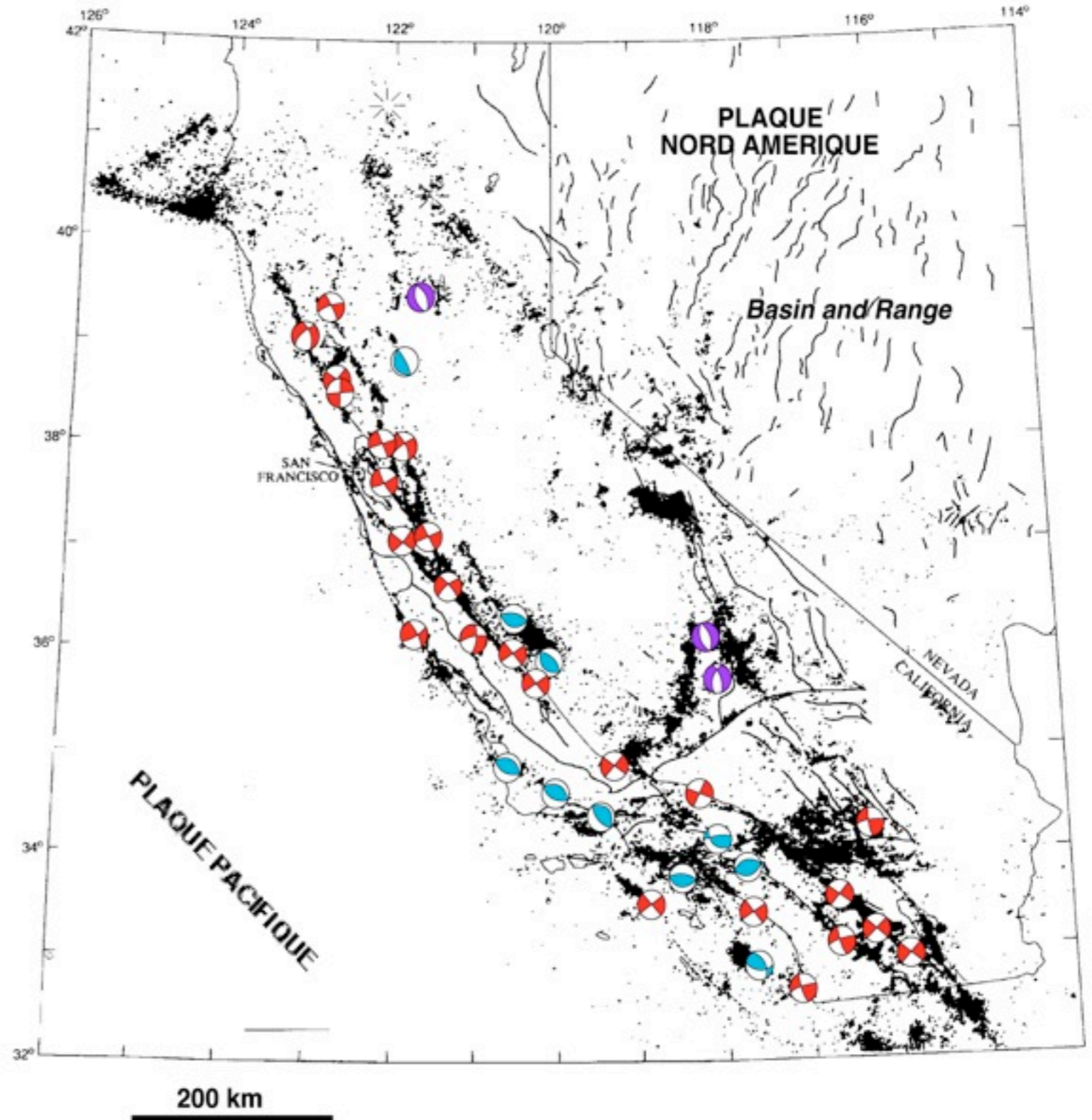
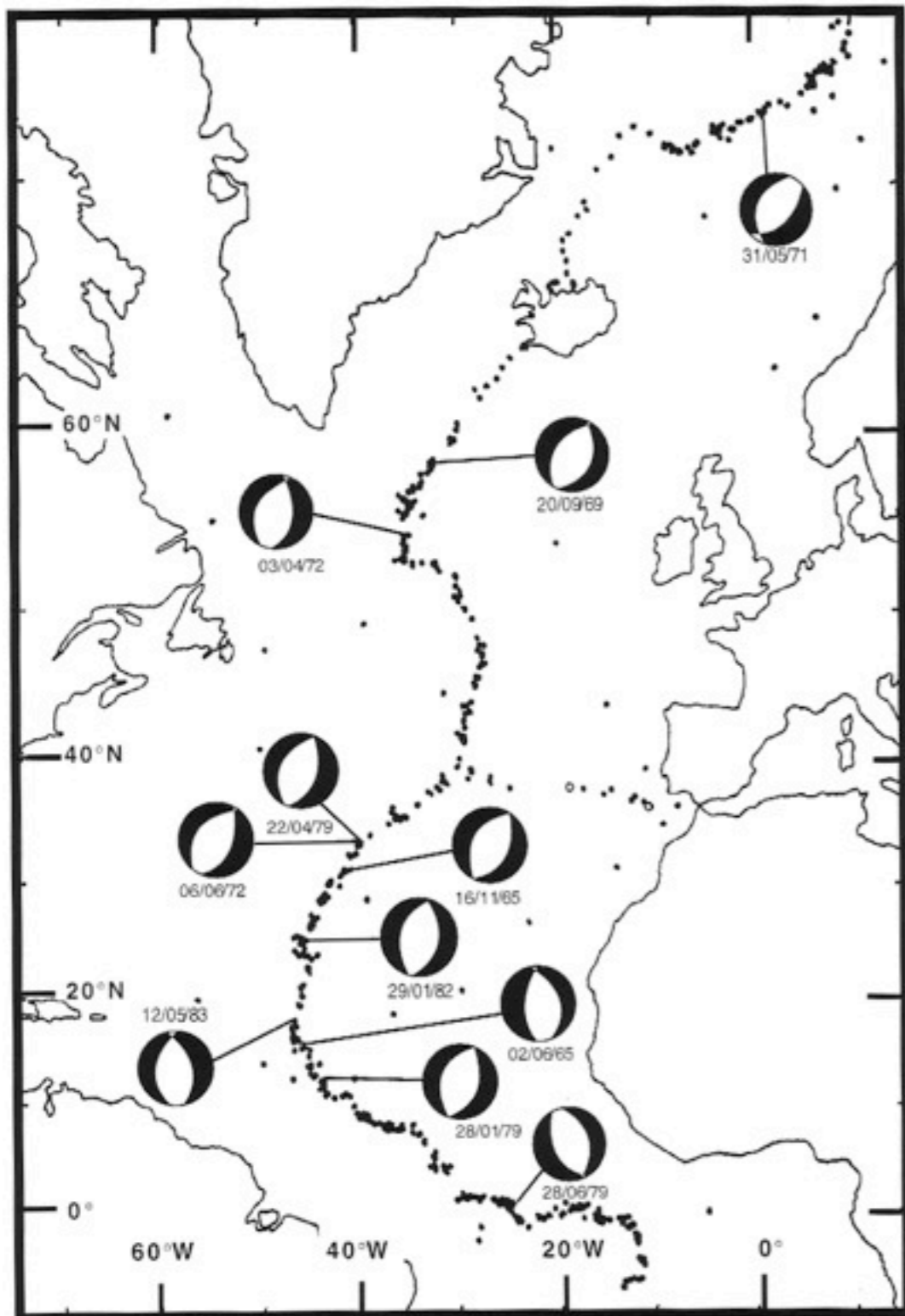



# Les directions des mouvements relatifs: les mécanismes au foyer des séismes

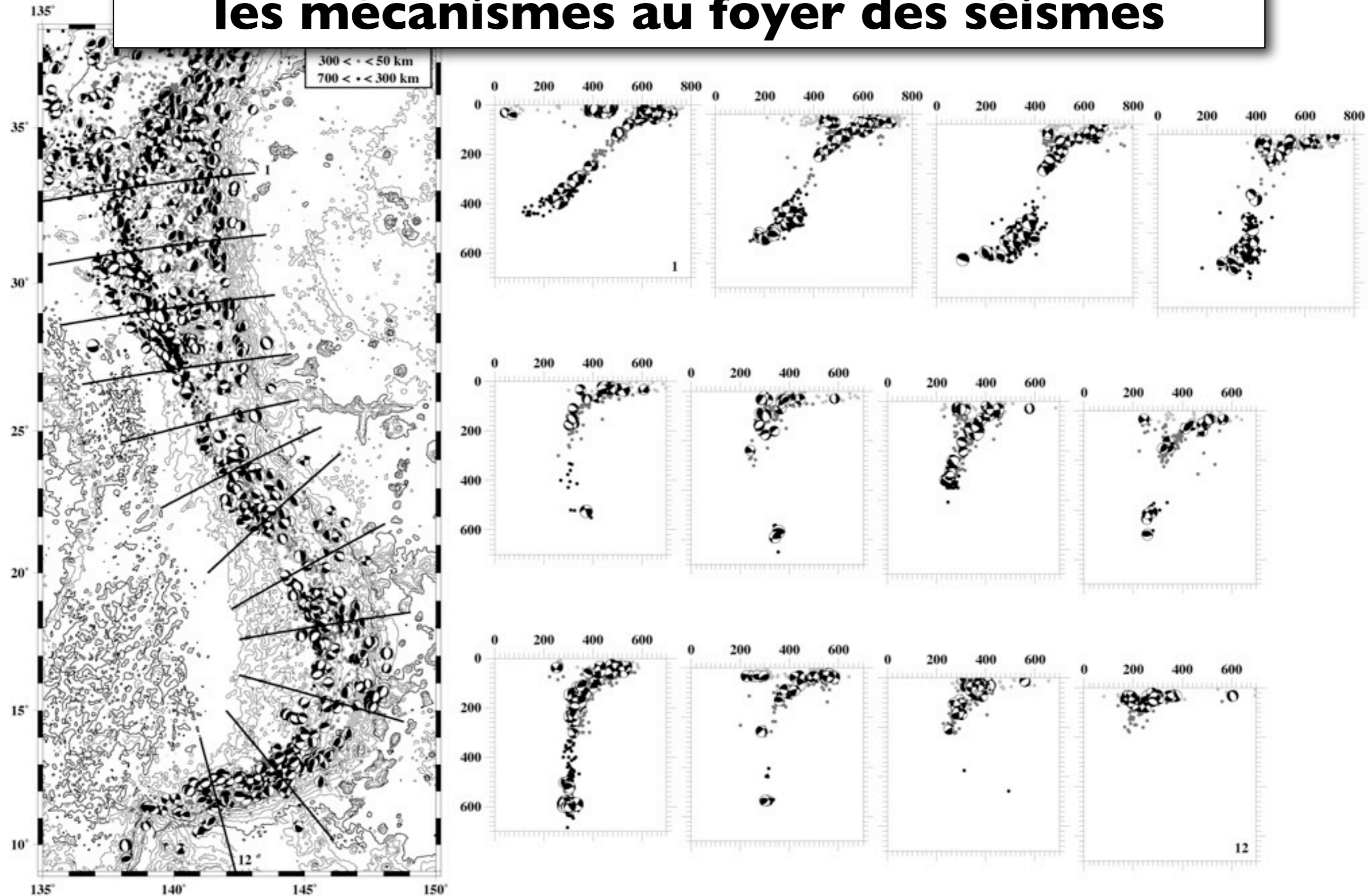

Coupes séries de la sismicité à travers la zone de subduction des Bonins-Mariannes



# Les directions des mouvements relatifs: les failles transformantes

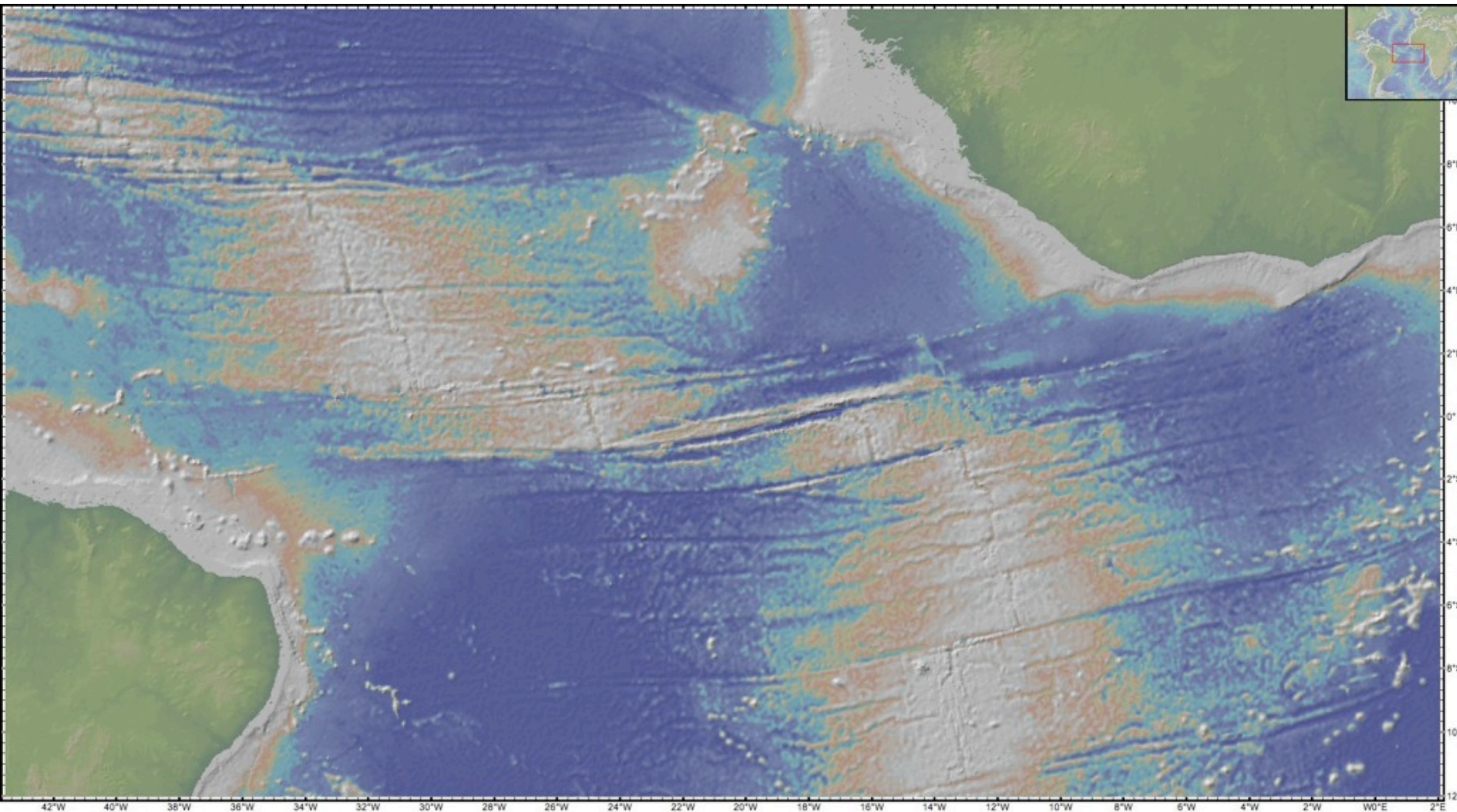



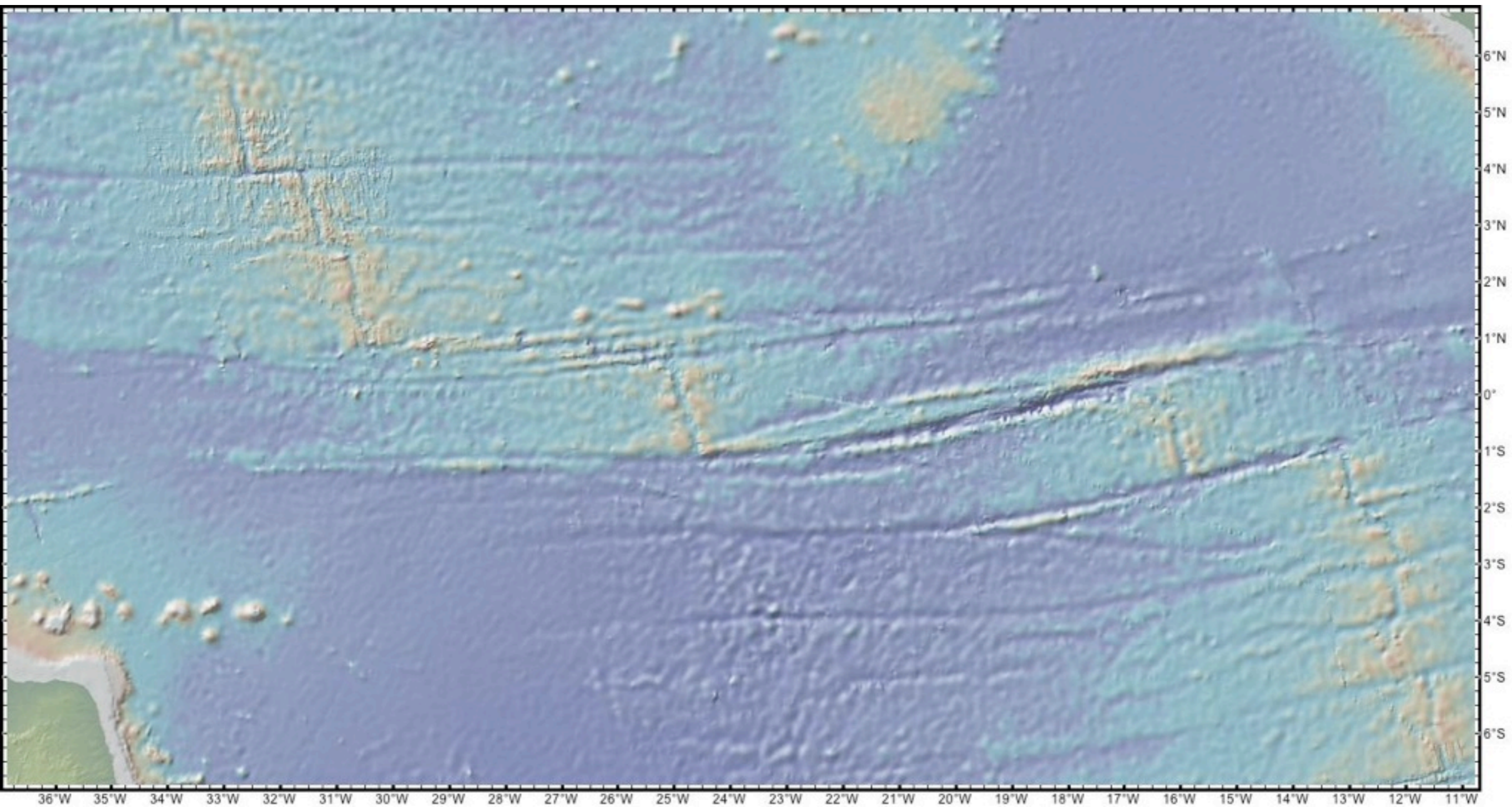

Les failles transformantes sont parallèles au mouvement relatif



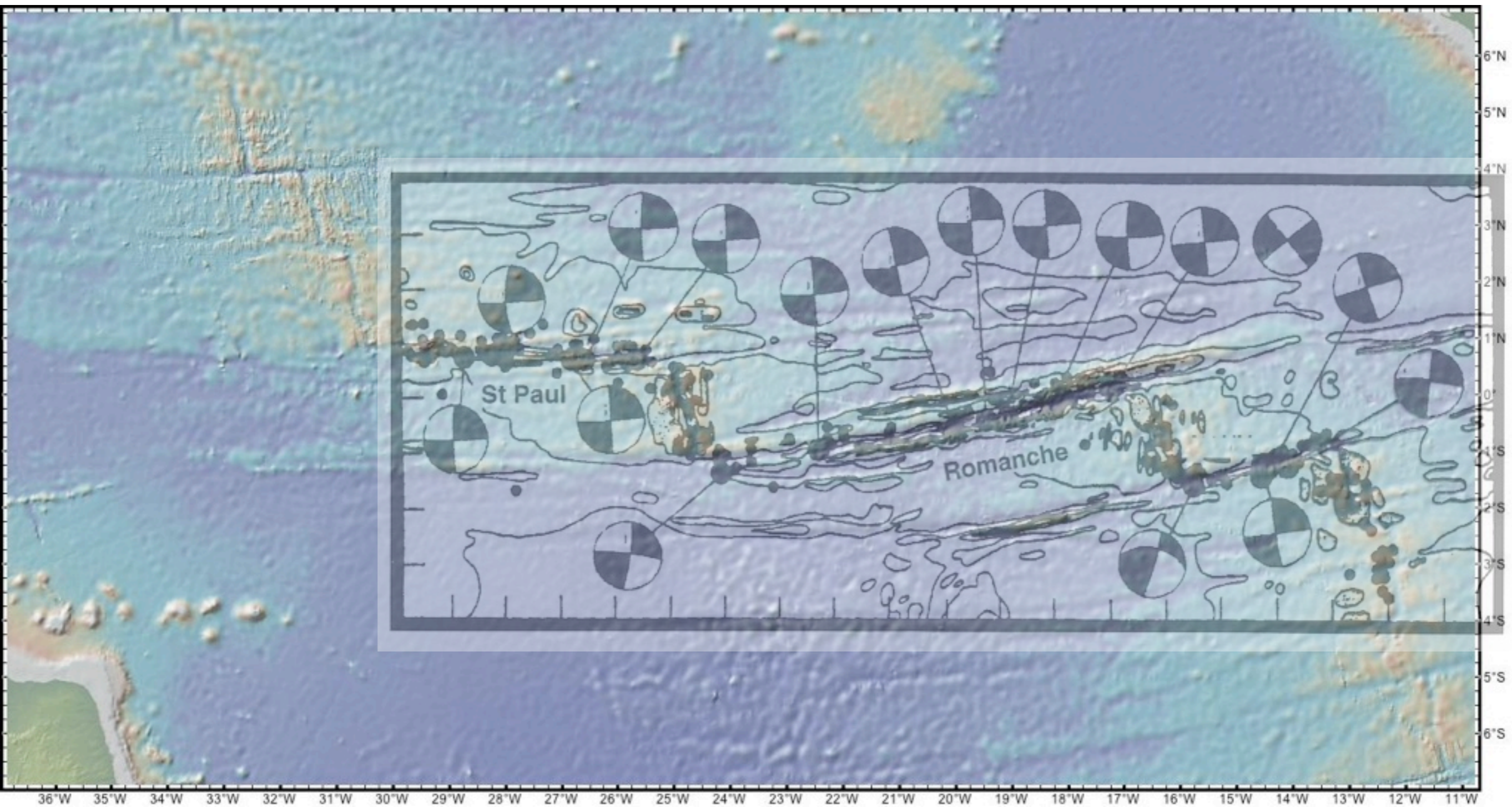

Les failles transformantes sont parallèles au mouvement relatif



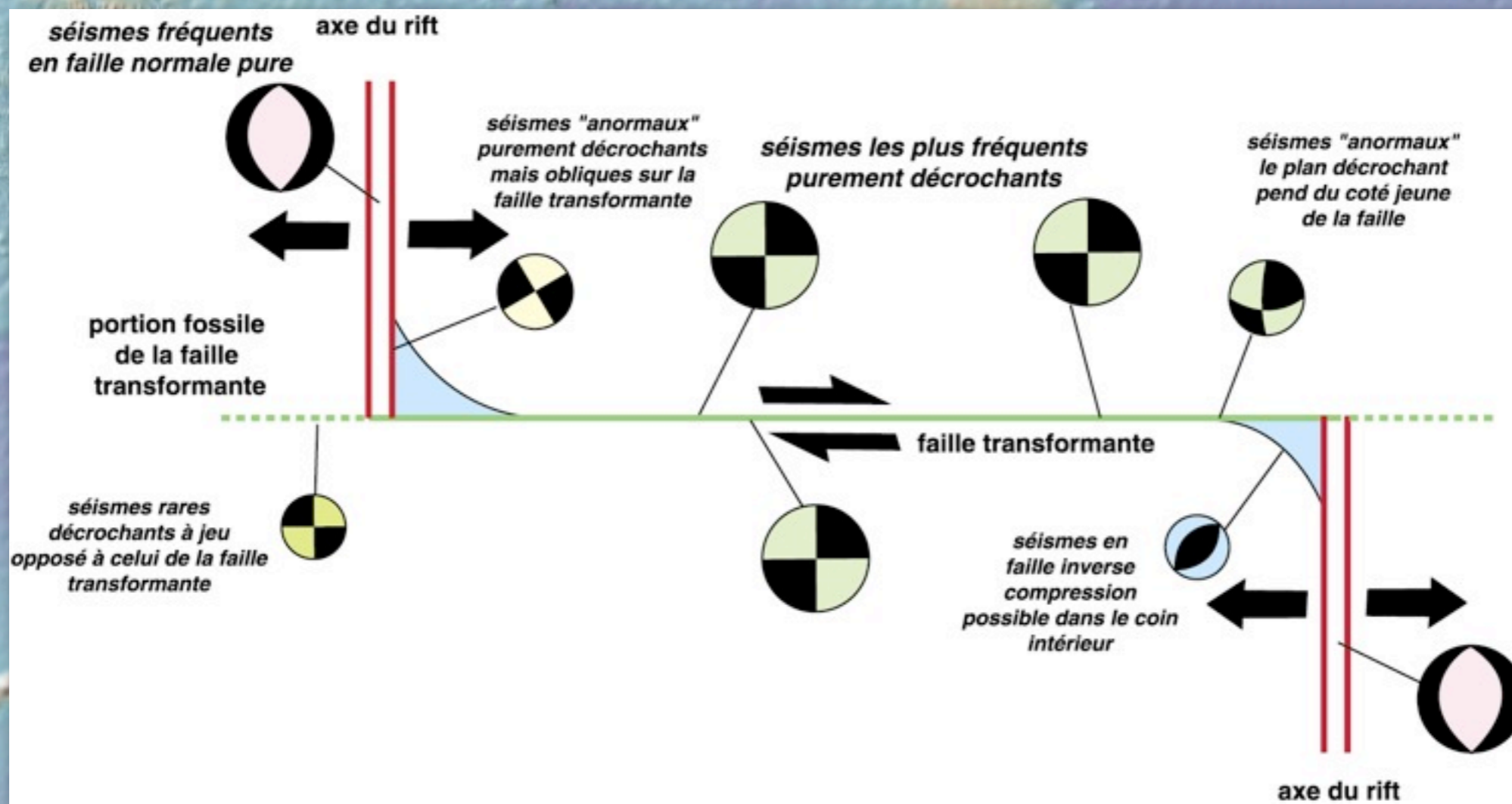

Les failles transformantes sont parallèles au mouvement relatif

# cinématique à deux plaques

*La géométrie eulérienne*



# Mechanism of Earthquakes and Nature of Faulting on the Mid-Oceanic Ridges<sup>1</sup>

LYNN R. SYKES

*Institute for Earth Sciences, ESSA, Lamont Geological Observatory, Columbia University  
Palisades, New York*

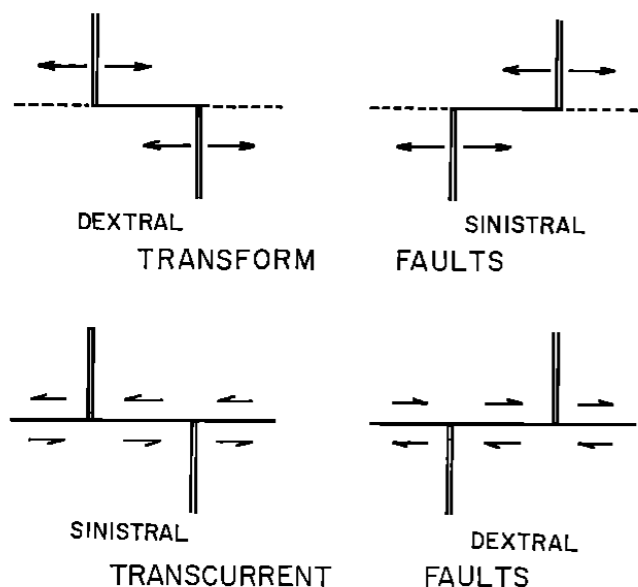

Fig. 1. Sense of motion associated with transform faults and transcurrent faults [after Wilson, 1965a]. Double line represents crest of mid-oceanic ridge; single line, fracture zone. The terms 'dextral' and 'sinistral' describe the sense of motion of the fracture zones; for the transform faults they do not denote the relative configuration of the two segments of ridge on either side of the fracture zone.

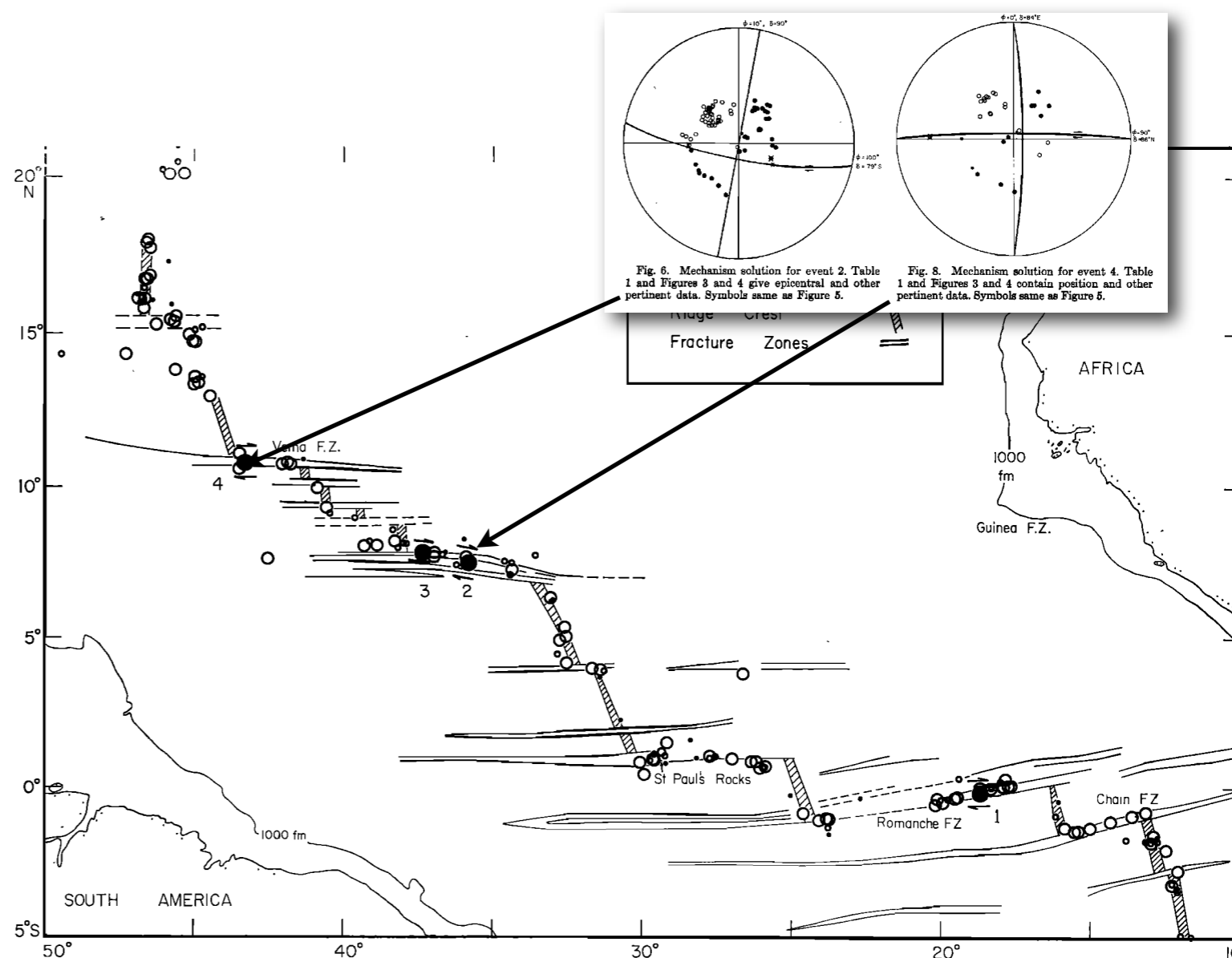

Fig. 4. Relocated epicenters of earthquakes (1955-1965) and mechanism solutions for four earthquakes along the equatorial portion of the mid-Atlantic ridge. Ridge crests and fracture zones from Heezen, Bunce, Hersey, and Tharp [1964] and Heezen, Gerard, and Tharp [1964]. Sense of shear displacement and strike of inferred fault plane are indicated by the orientation of the set of arrows beside each mechanism. Numbers beside mechanism solutions refer to data in Table 1. Large circles denote more precise epicentral determinations; smaller circles, poorer determinations.

L. Sykes propose le premier test  
des idées de Wilson  
sur les failles transformantes

# Rises, Trenches, Great Faults, and Crustal Blocks<sup>1</sup>

W. JASON MORGAN

*Department of Geology, Princeton University, Princeton, New Jersey 08540  
and Department of Geology and Geophysics, Woods Hole Oceanographic Institution  
Woods Hole, Massachusetts 02543*

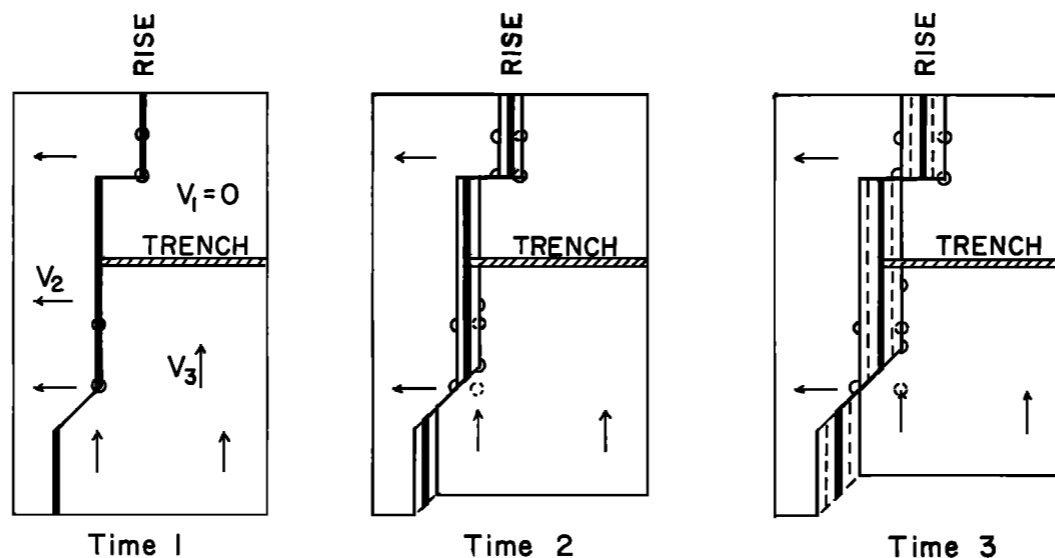

J. Morgan montre pour la première fois la réalité de la géométrie en petit cercle des failles transformantes et propose la notion de pôle de rotation et de blocs rigides. Il délimite des plaques rigides

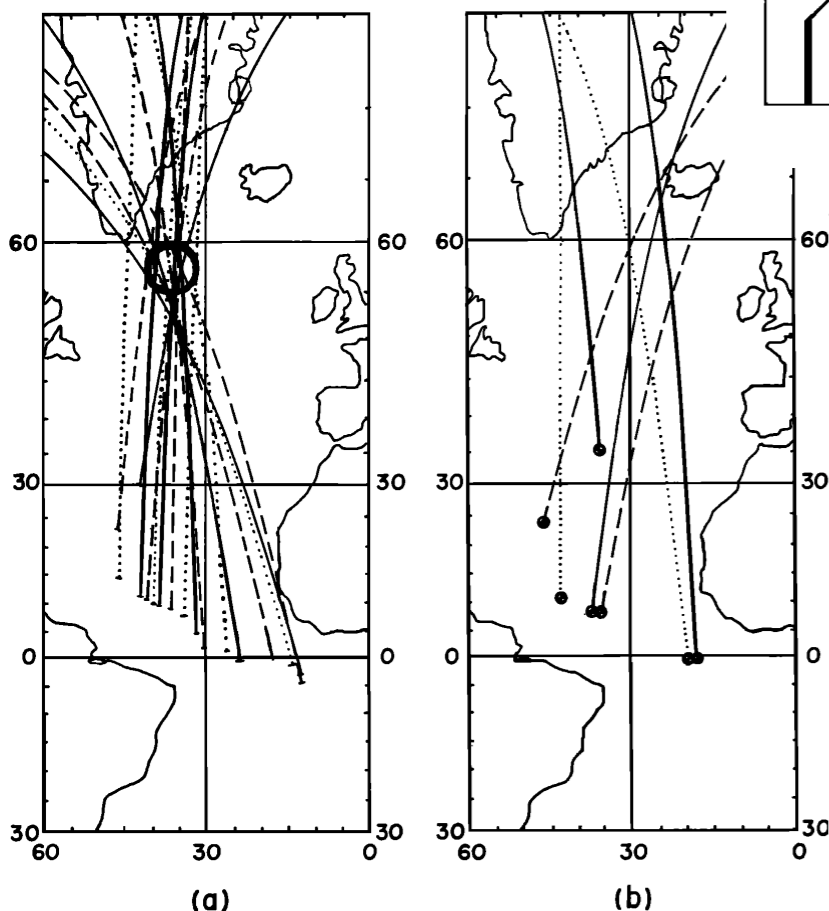

Fig. 8. Great circles perpendicular to the strike of offsets of the mid-Atlantic ridge are shown in (a). With one exception, all of these lines pass within the circle centered at 58°N, 36°W. Great circles perpendicular to the strike determined by earthquake mechanism solutions are shown in (b).

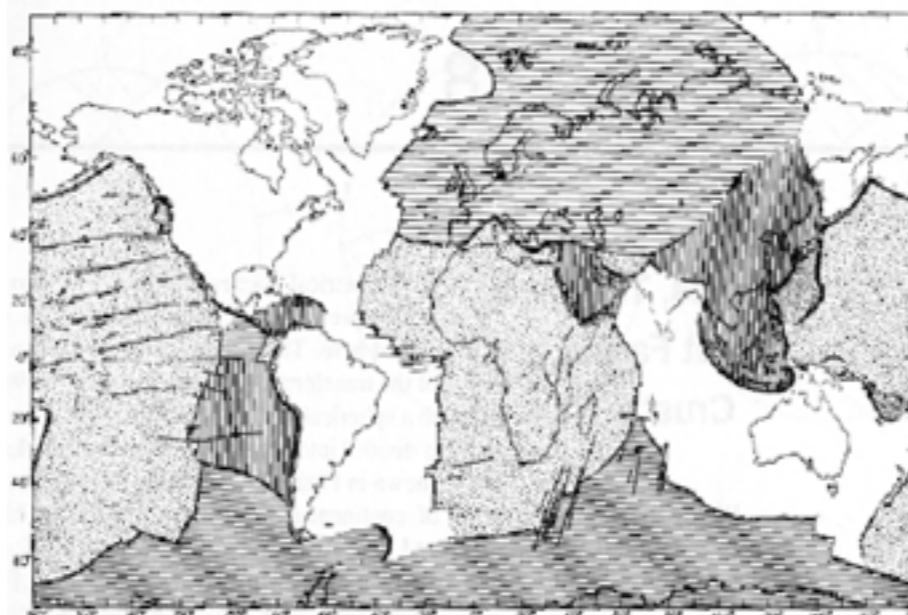

Figure 8-1

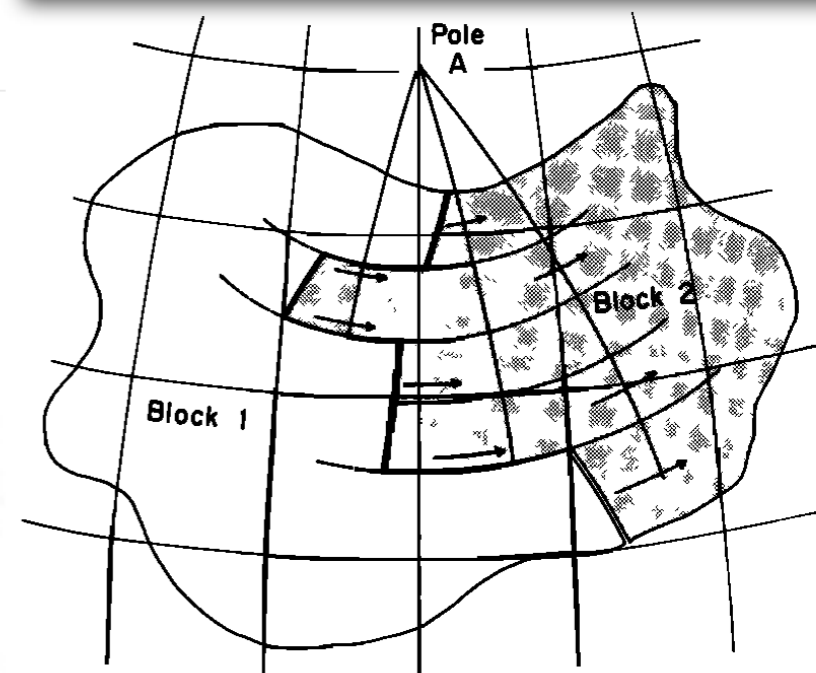
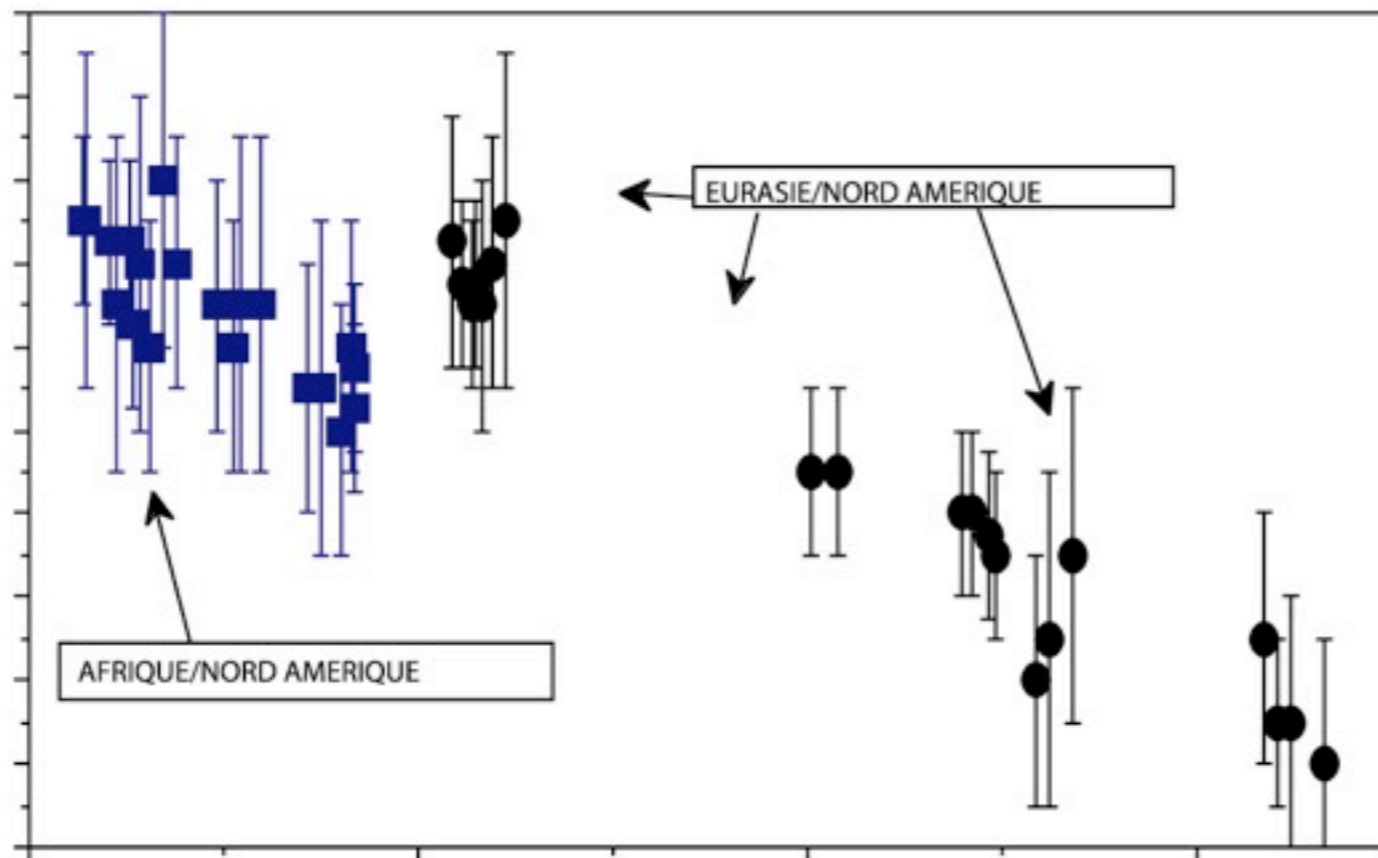
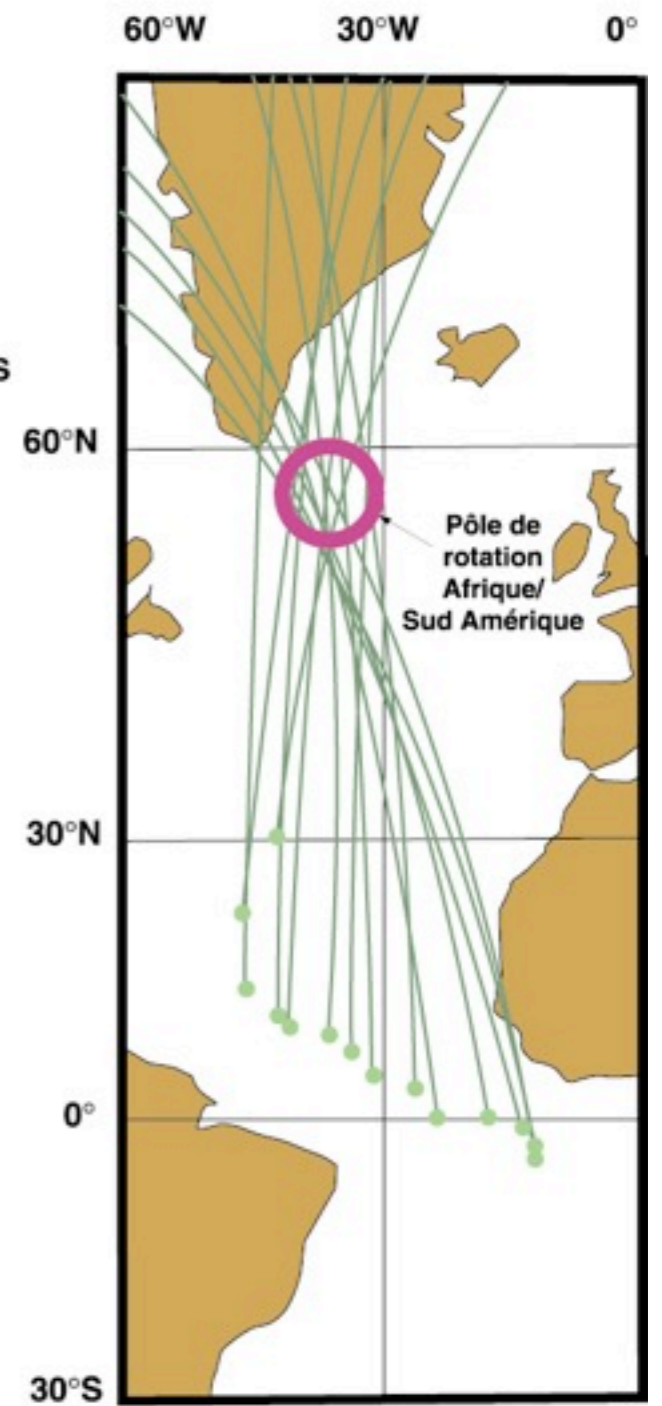
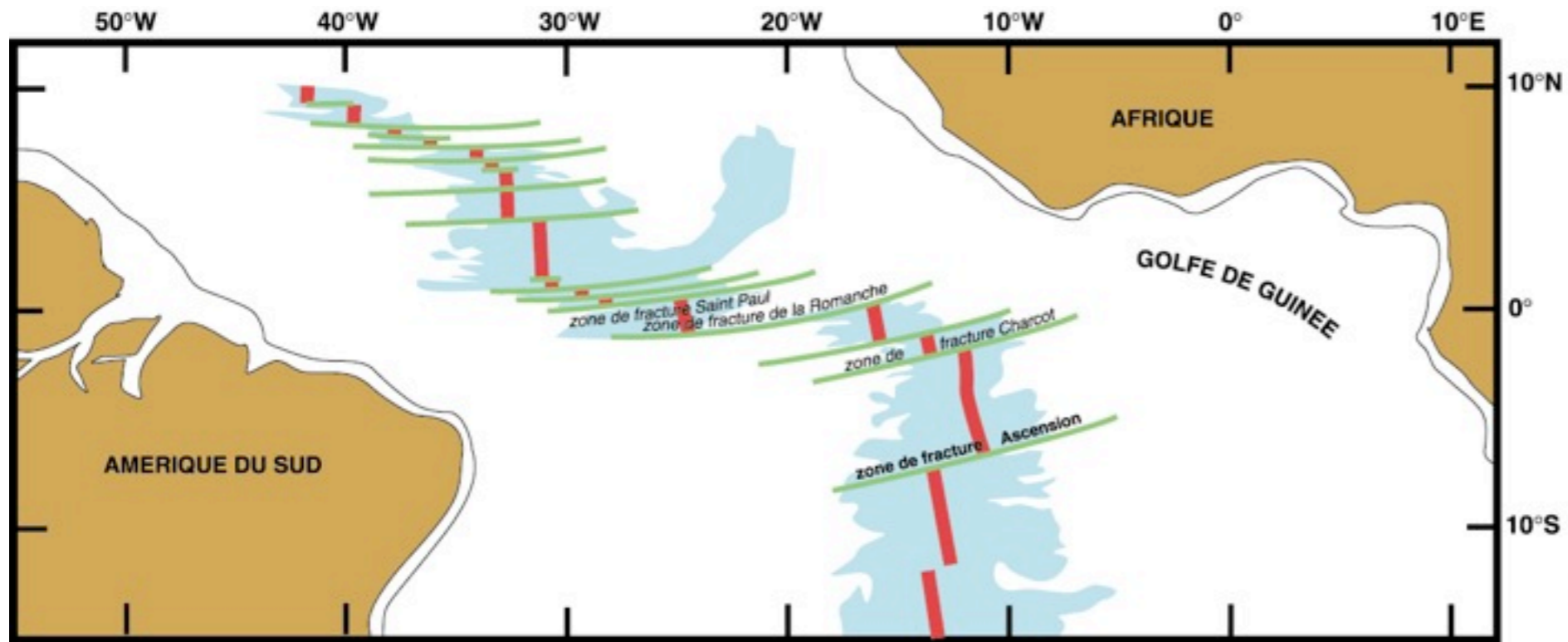
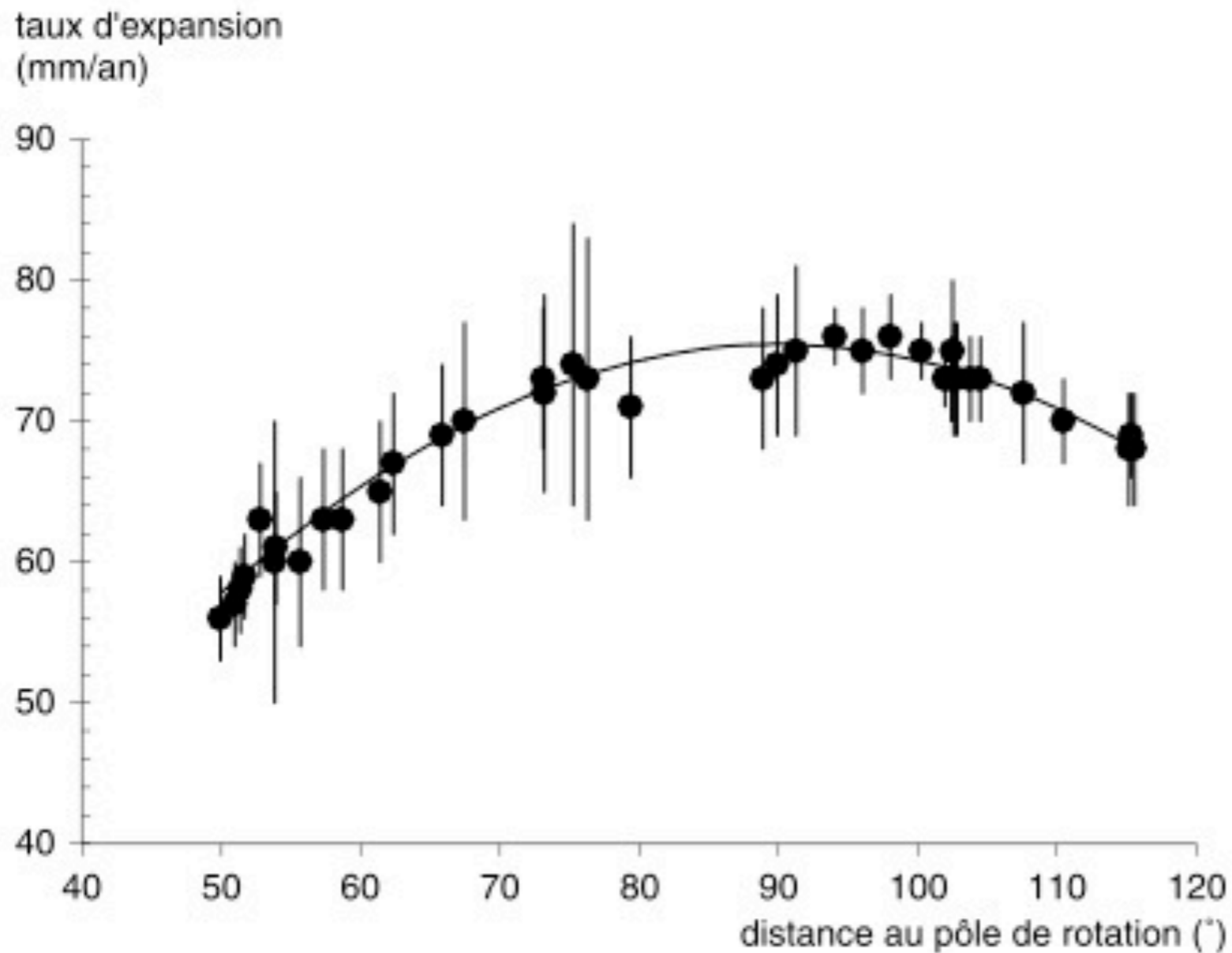

Fig. 4. On a sphere, the motion of block 2 relative to block 1 must be a rotation about some pole. All faults on the boundary between 1 and 2 must be small circles concentric about the pole A.





# Variation de la vitesse d'ouverture en fonction de la distance au pôle de rotation



*(Westphal et al., 2003)*



# Variation de la vitesse d'ouverture en fonction de la distance au pôle de rotation

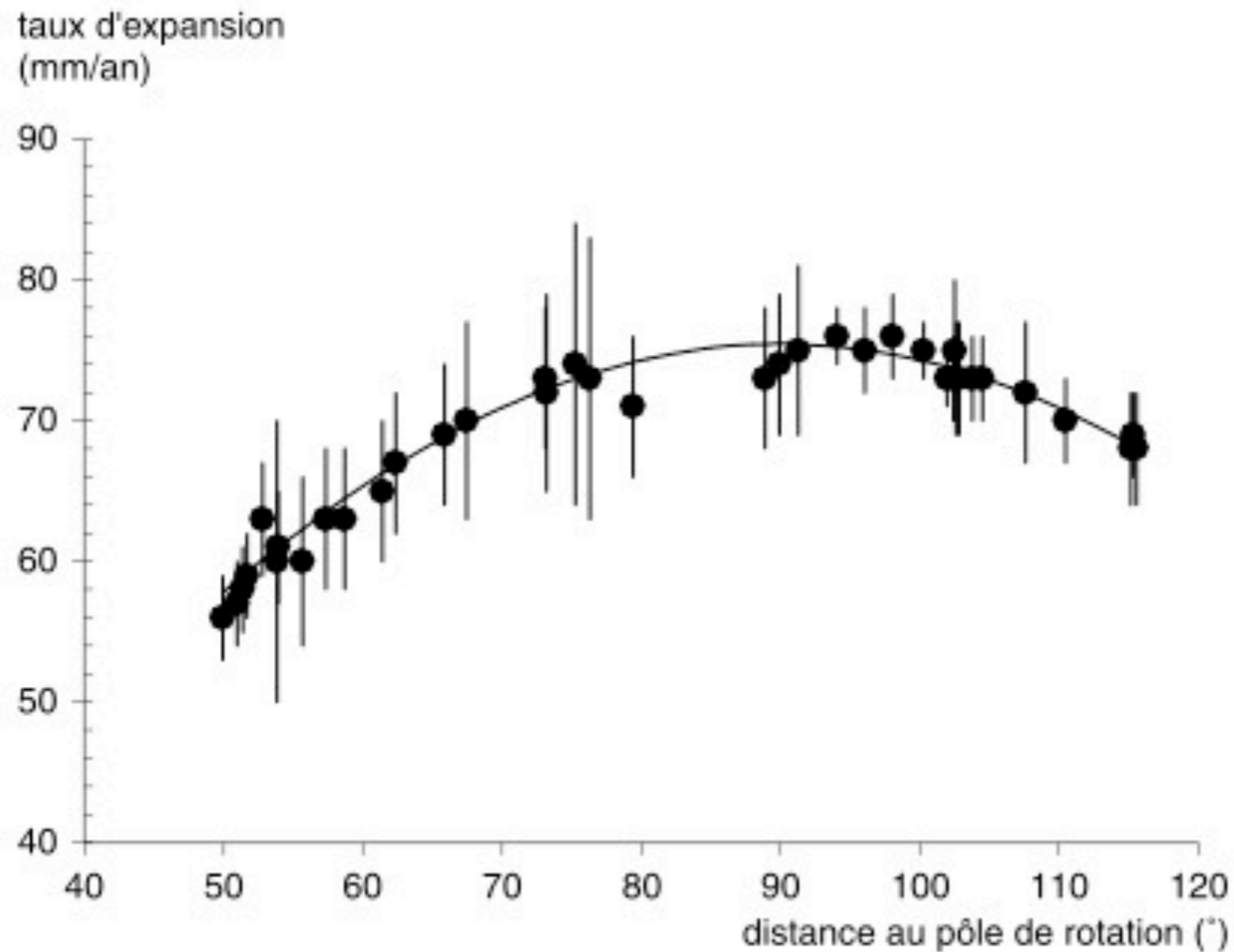

- Vitesse maximale à  $90^\circ$  du pôle de rotation

*(Westphal et al., 2003)*

# Variation de la vitesse d'ouverture en fonction de la distance au pôle de rotation

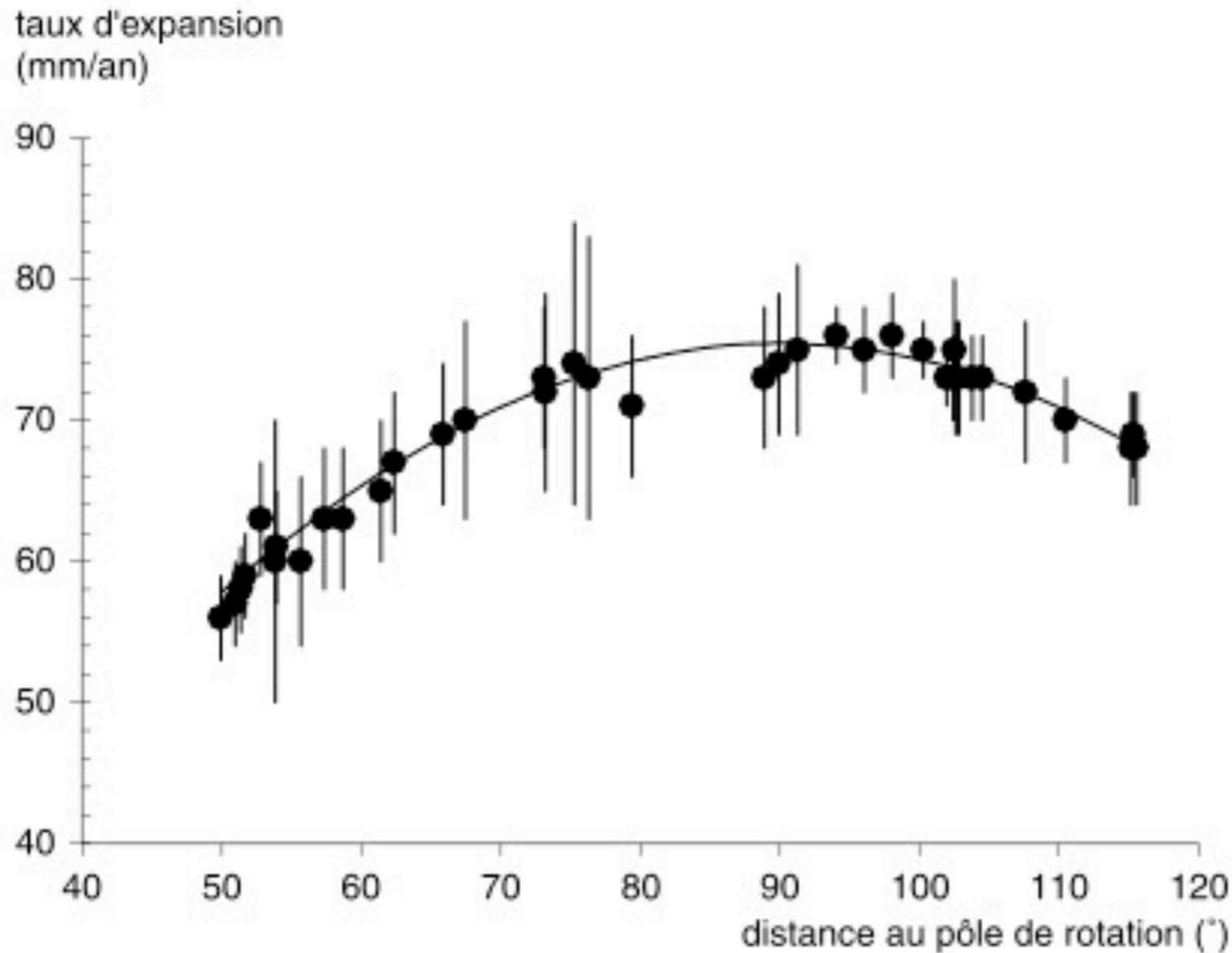

- Vitesse maximale à  $90^\circ$  du pôle de rotation
- Variation en sinus de la distance angulaire

*(Westphal et al., 2003)*



# The North Pacific: an Example of Tectonics on a Sphere

by

D. P. McKENZIE

R. L. PARKER

Institute of Geophysics and Planetary Physics,  
University of California at San Diego

Individual aseismic areas move as rigid plates on the surface of a sphere. Application of the Mercator projection to slip vectors shows that the paving stone theory of world tectonics is correct and applies to about a quarter of the Earth's surface.

D. McKenzie et R.L. Parker  
testent également de leur côté  
les hypothèses de Wilson avec  
des blocs rigides.

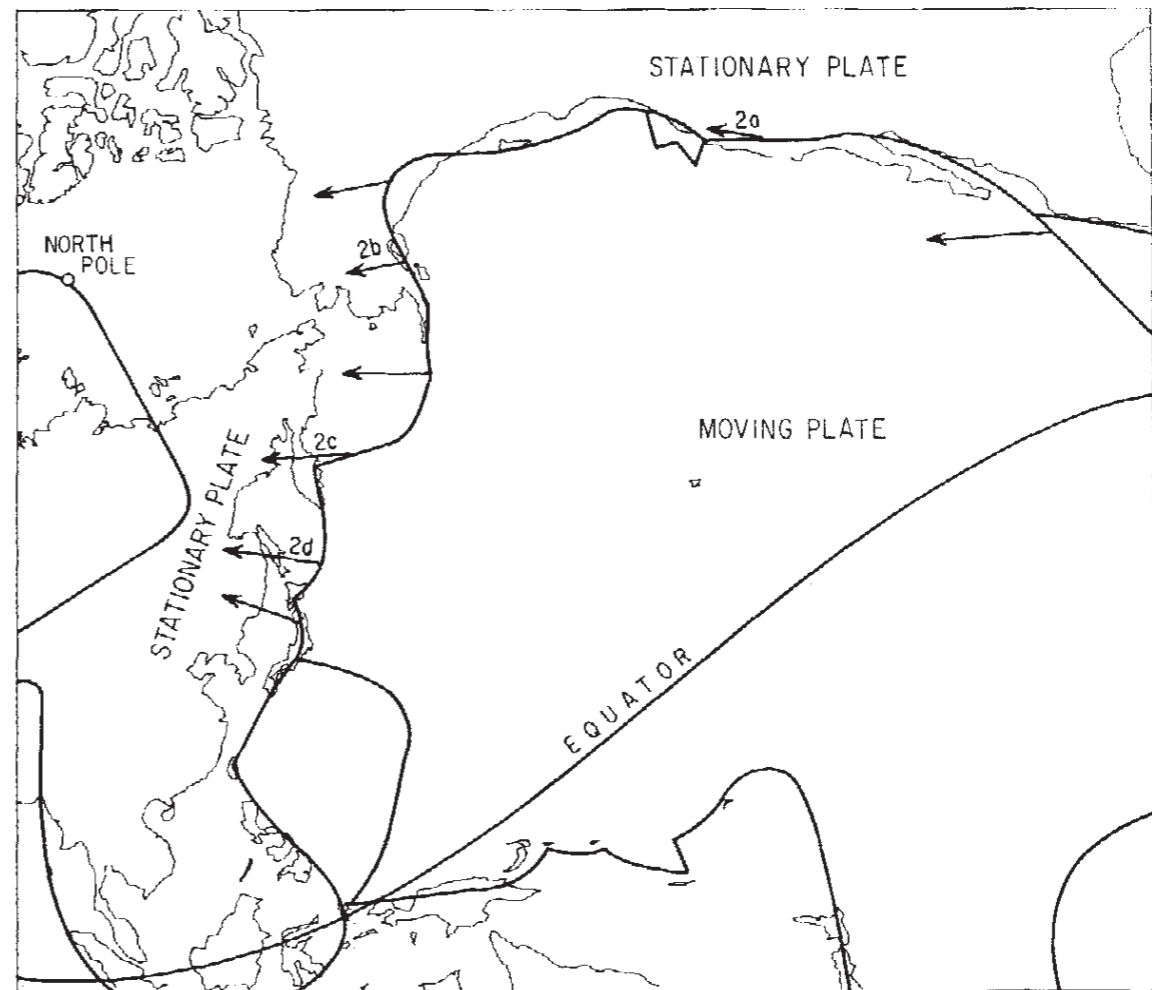
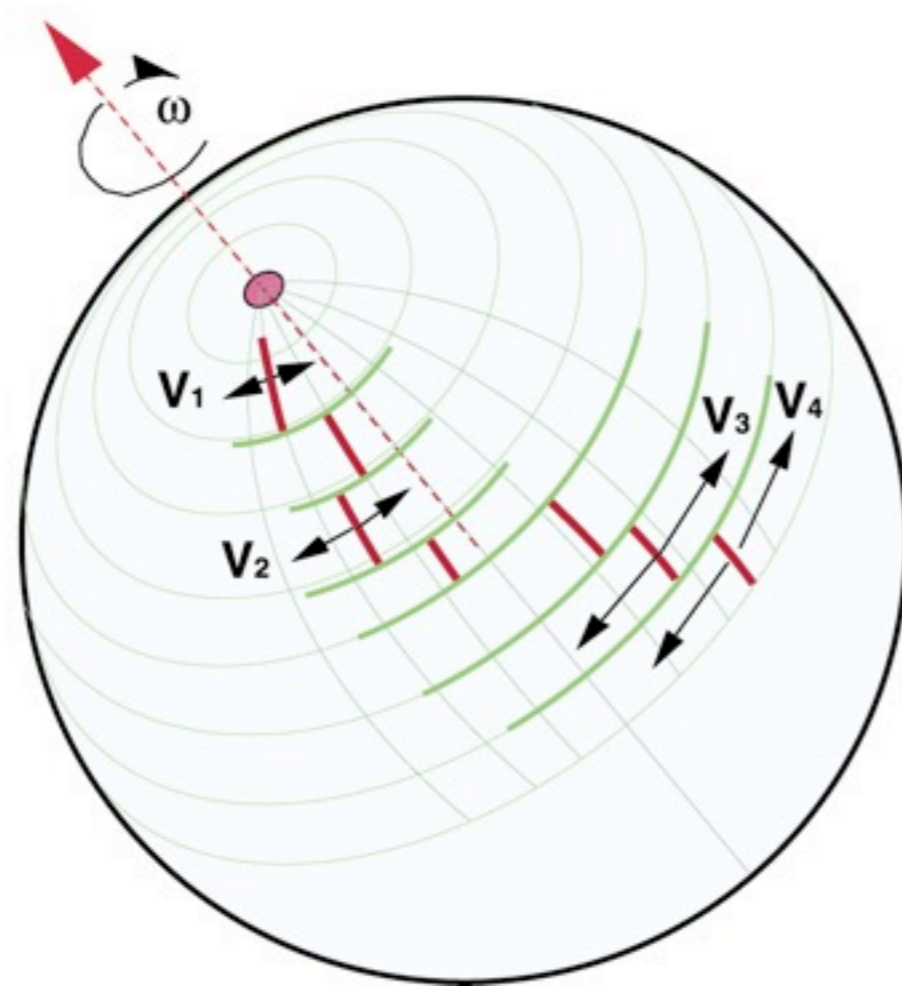
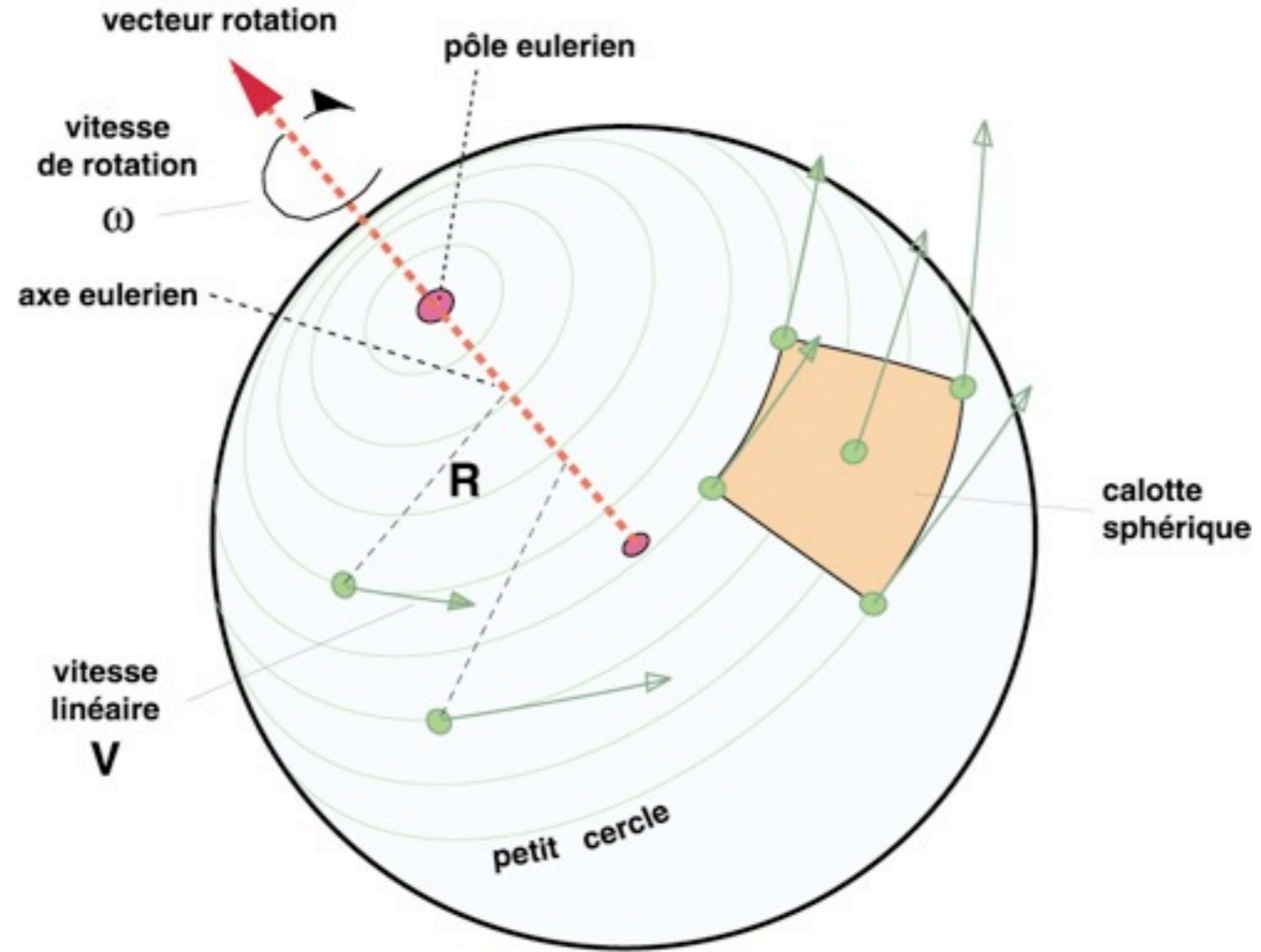

Fig. 3. A Mercator projection of the Pacific with a pole at 50° N., 85° W. The arrows show the direction of motion of the Pacific plate relative to that containing North America and Kamchatka. If both plates are rigid all slip vectors must be parallel with each other and with the upper and lower boundaries of the figure. Possible boundaries of other plates are sketched.





# cinématique à trois plaques

*Les points triples*

# Les points triples

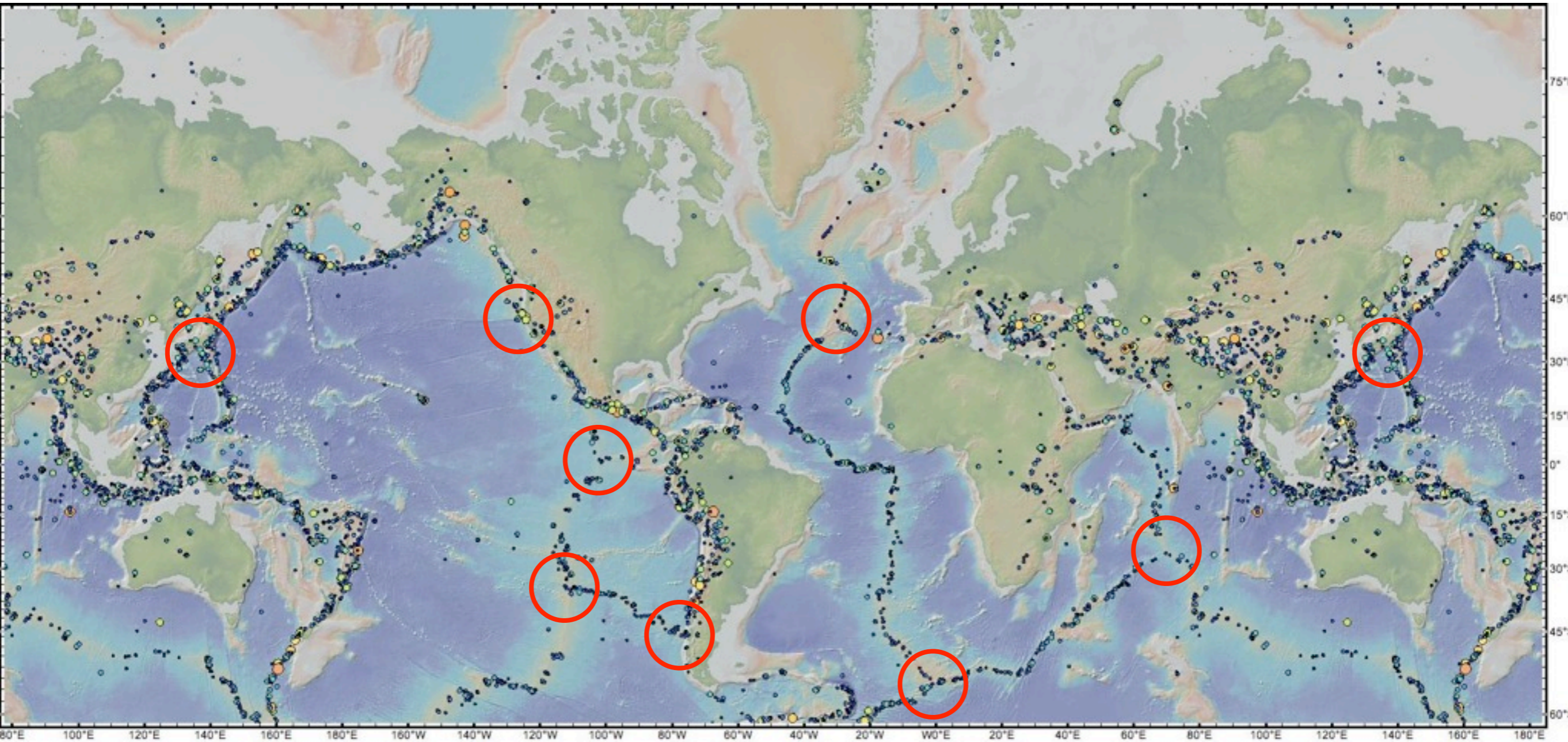



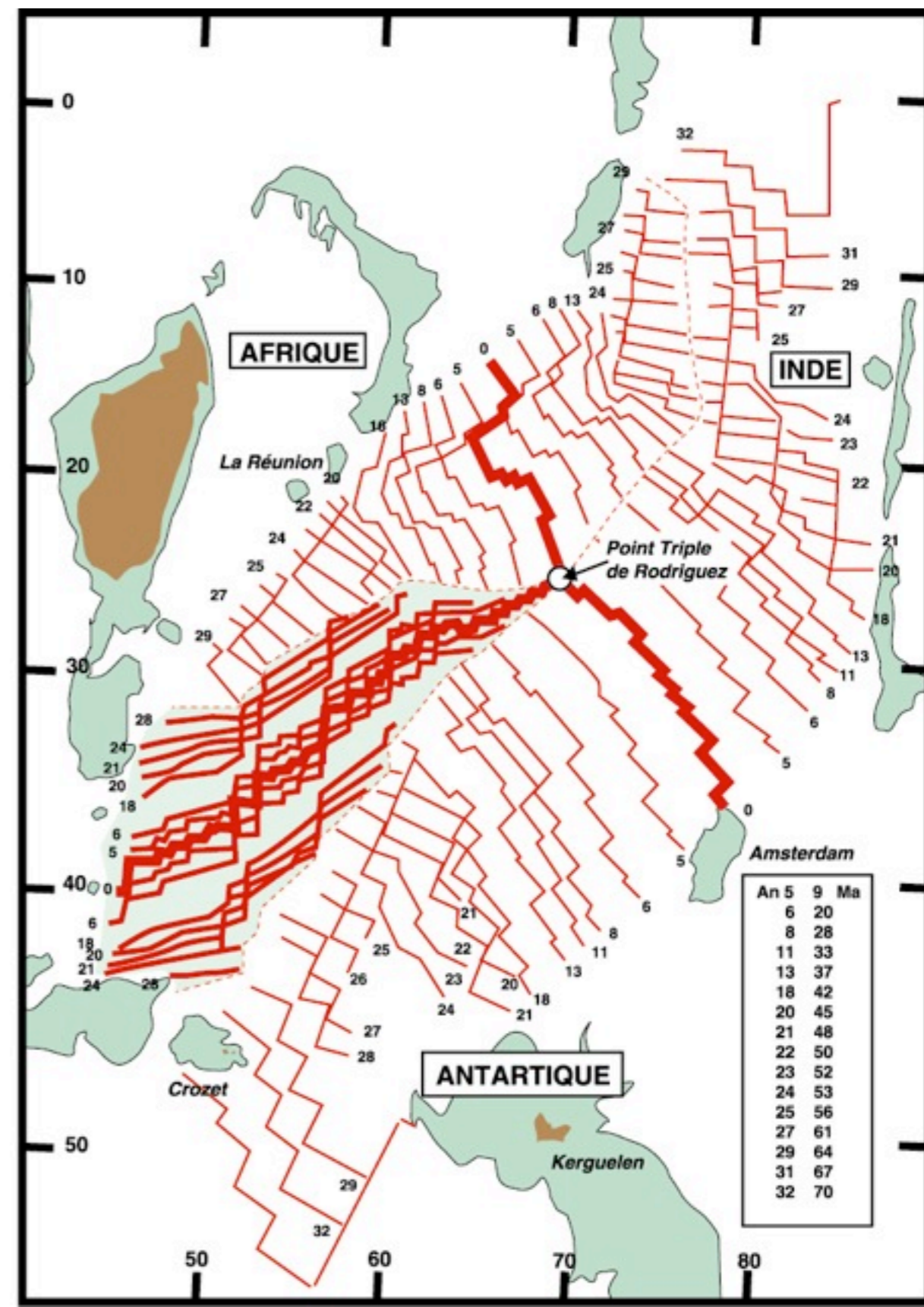
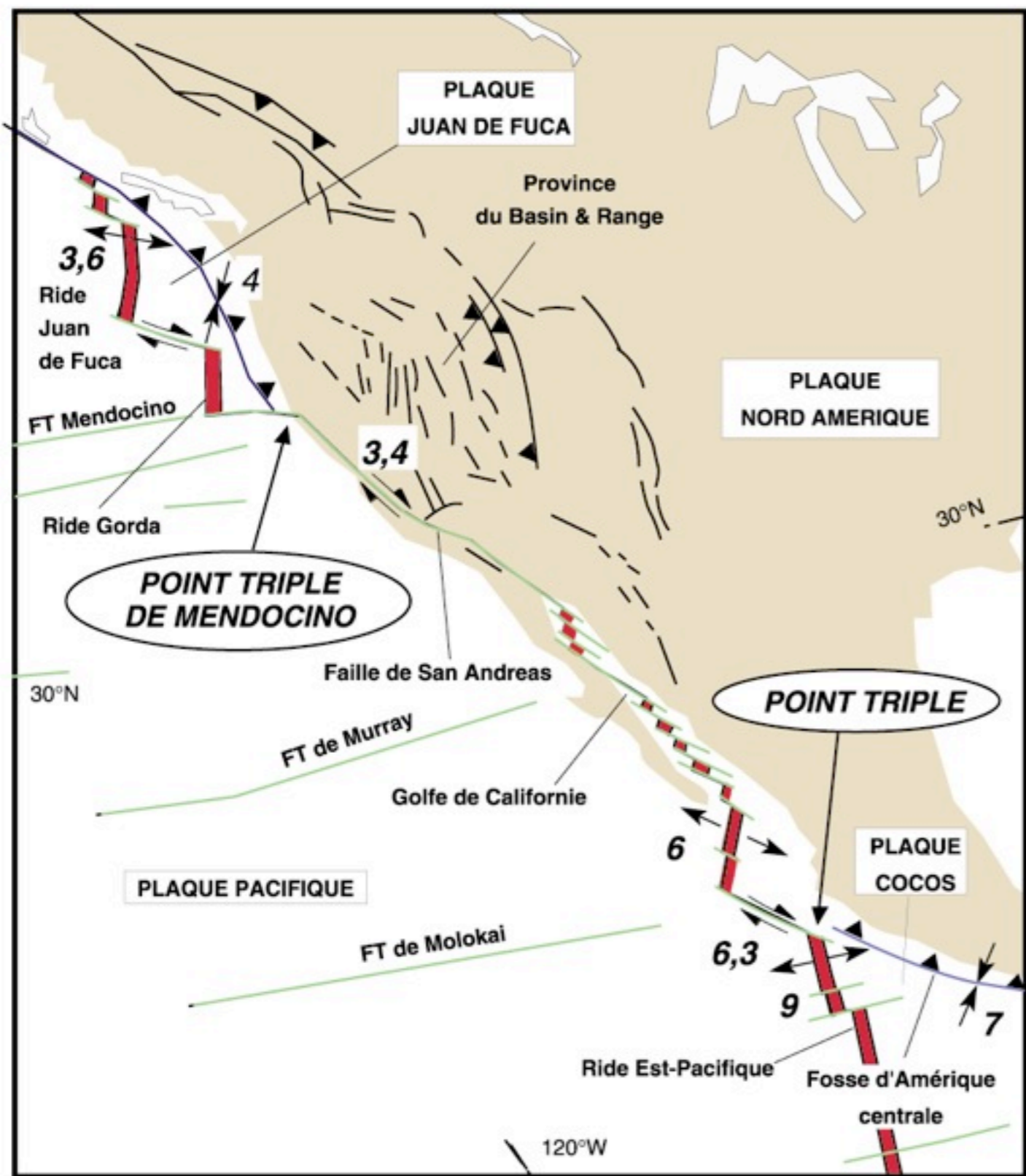

# Evolution of Triple Junctions

by

D. P. MCKENZIE

Department of Geodesy and Geophysics,  
University of Cambridge,  
and  
Seismological Laboratory,  
California Institute of Technology

W. J. MORGAN

Department of Geology,  
Princeton University

The simple geometric ideas of plate theory are extended to include some forms of plate evolution. The most important of these occurs where three plates meet. Such triple junctions are divided into two groups, stable and unstable, according to whether or not they can retain their geometry as the plates move. These ideas suggest an explanation for some of the major changes which have occurred in the North Pacific during the Tertiary.

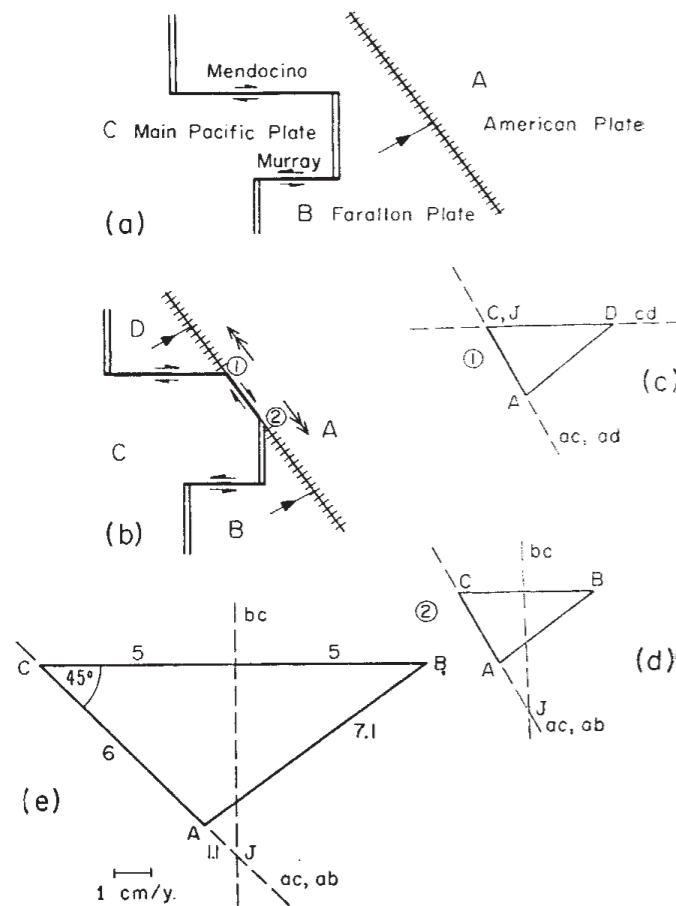

Fig. 5. (a) The geometry of the north-east Pacific at about the time of anomaly 13. All fracture zones except the Mendocino and the Murray have been omitted for simplicity. (b) Stable triple junctions at about the time of anomaly 9, formed when the east Pacific met the trench of western North America. The double headed arrows show the motion of the two junctions (1) and (2) relative to the American plate *A*. (c) is a sketch of the vector velocity diagram for junction (1) and shows it will move north-west with the Main Pacific plate. (d) is a similar diagram for (2). If the relative plate motions have not changed since at least the Middle Oligocene, the magnetic lineations and the present motion on the San Andreas may be used to draw the velocity diagrams to scale. (e) is such a drawing of (d), and shows that the triple junction *J* will slowly move to the south-east relative to *A*. The numbers are in cm/yr and the vector *AB* shows the direction and rate of consumption of the Farallon plate by the American.

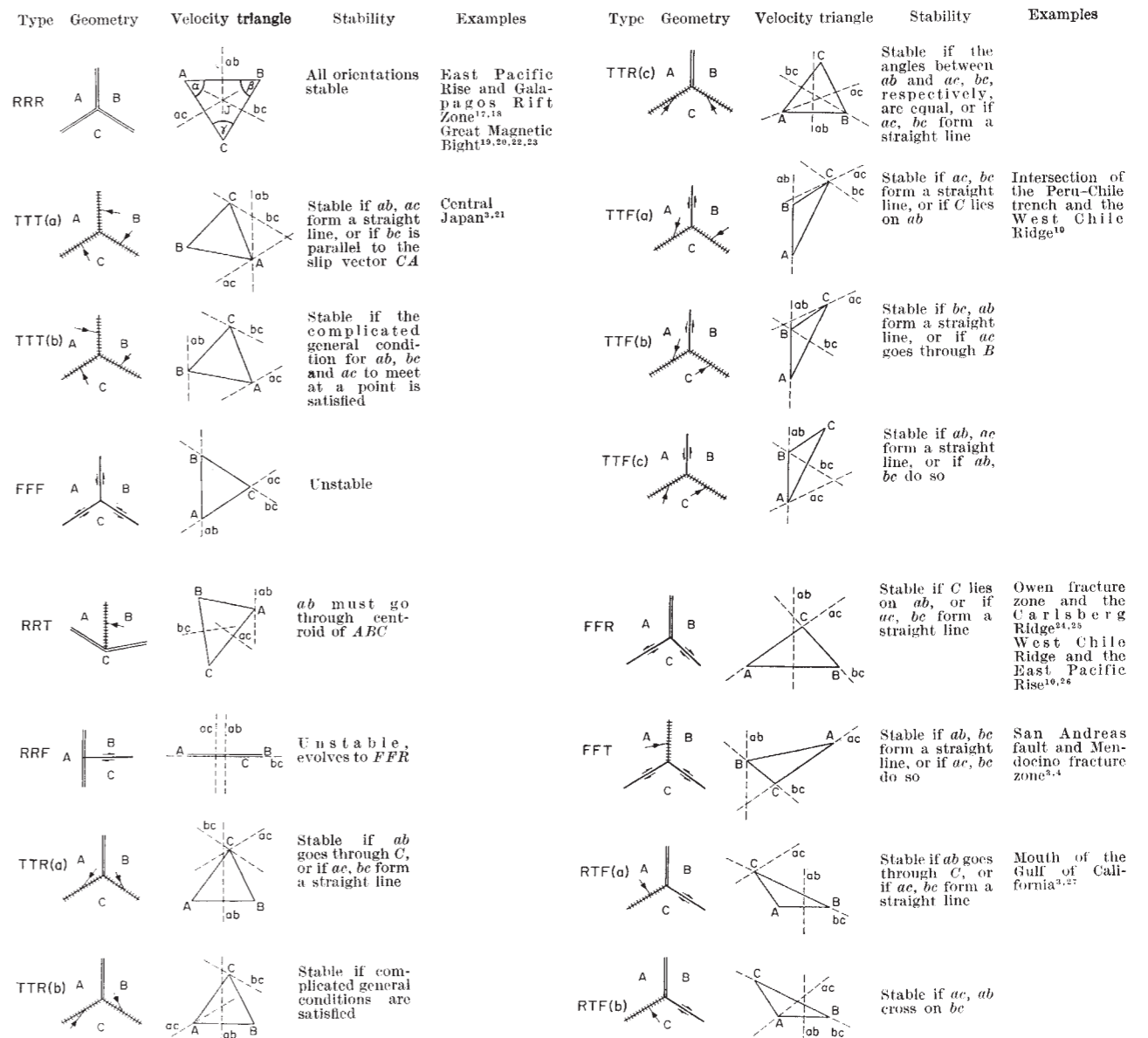
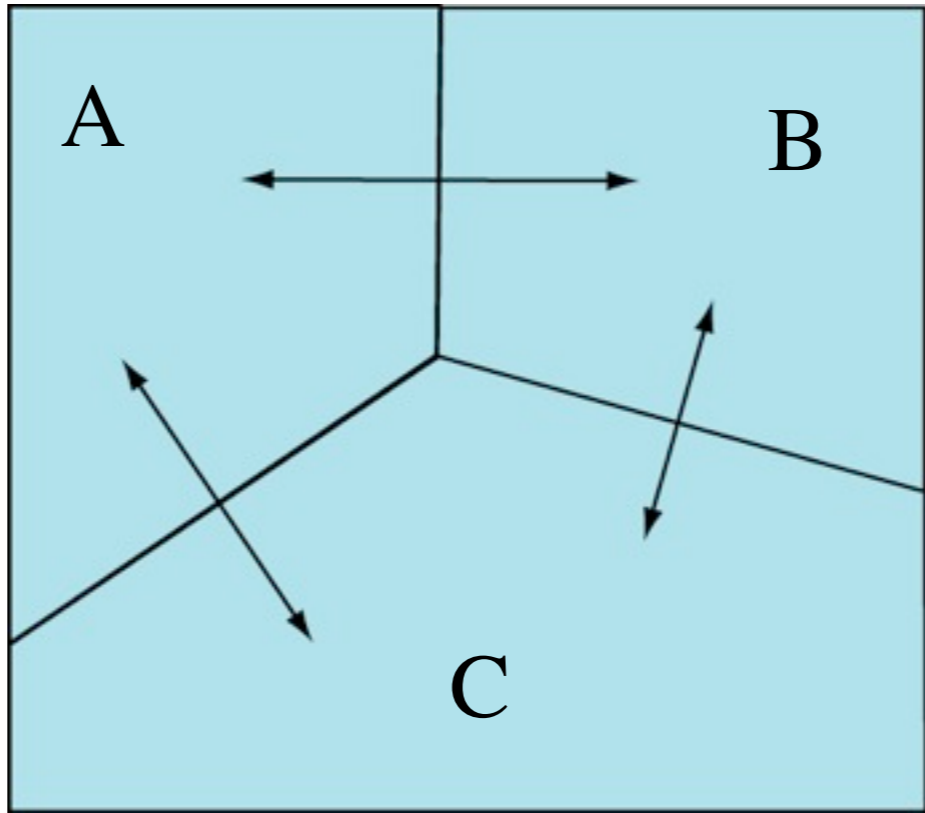
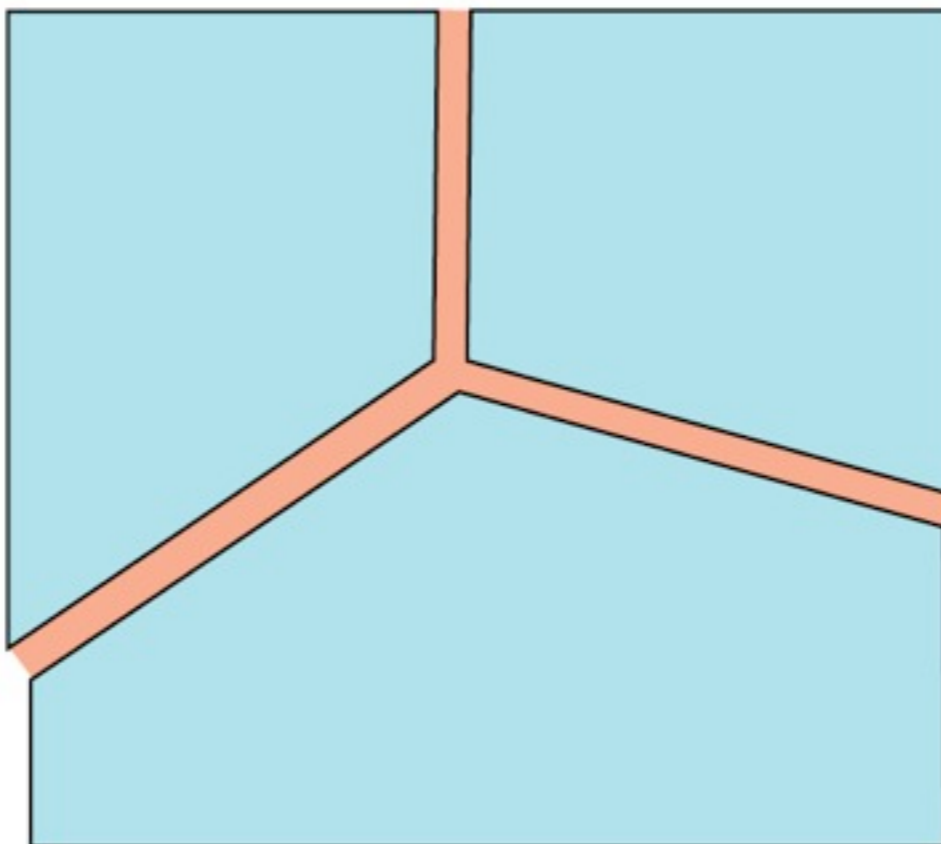

Fig. 3. The geometry and stability of all possible triple junctions. Representation of structures is the same as in Fig. 1. Dashed lines *ab*, *bc* and *ac* in the velocity triangles join points the vector velocities of which leave the geometry of *AB*, *BC* and *AC*, respectively, unchanged. The relevant junctions are stable only if *ab*, *bc* and *ac* meet at a point. This condition is always satisfied by *RRR*; in other cases the general velocity triangles are drawn to demonstrate instability. Several of the examples are speculative.









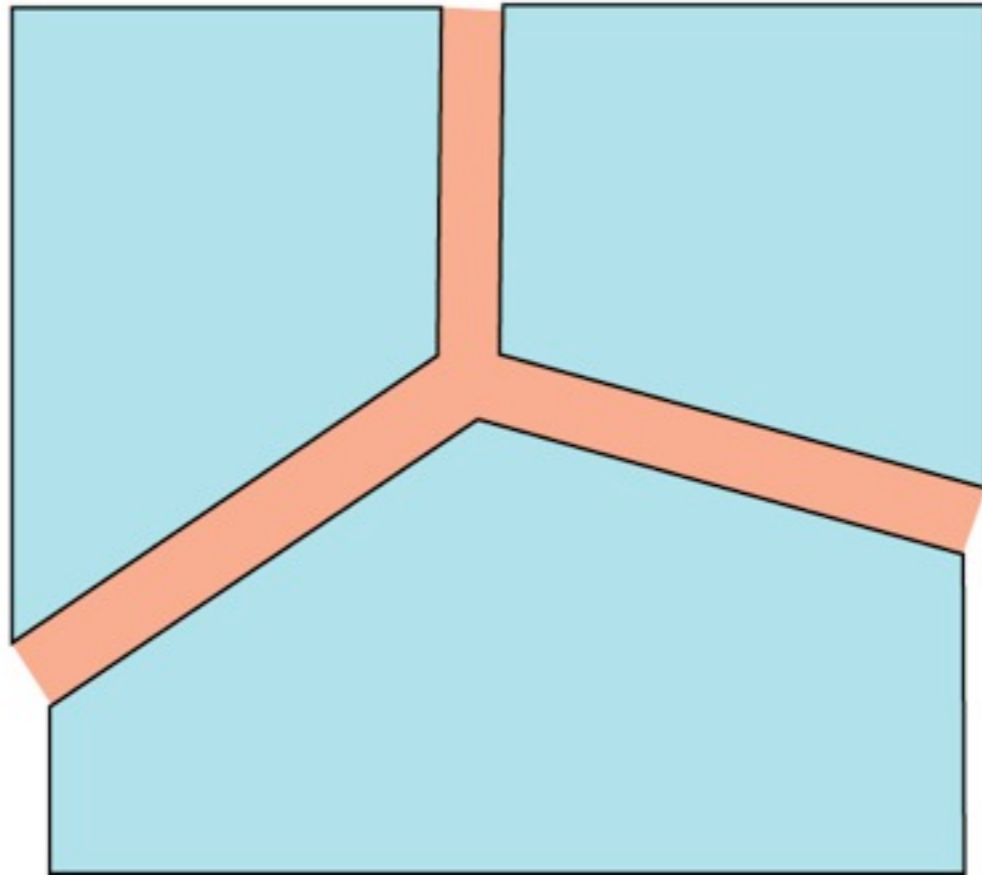

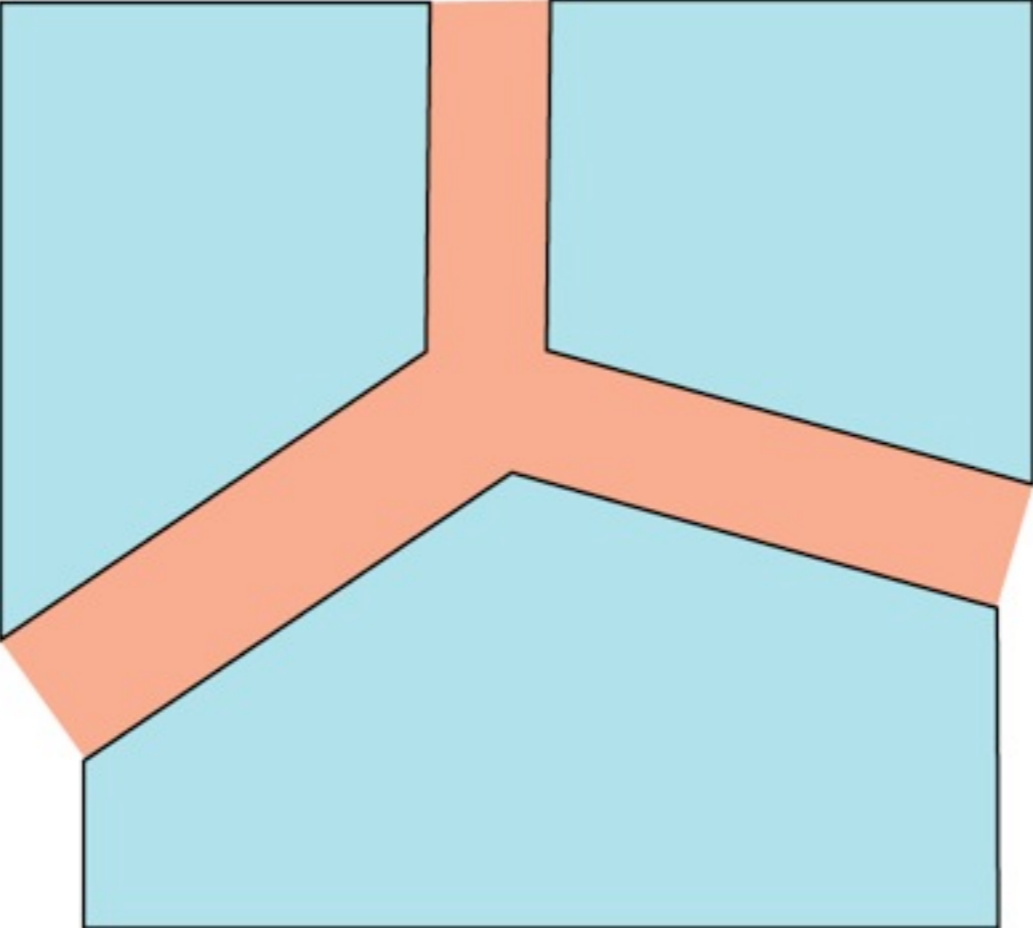



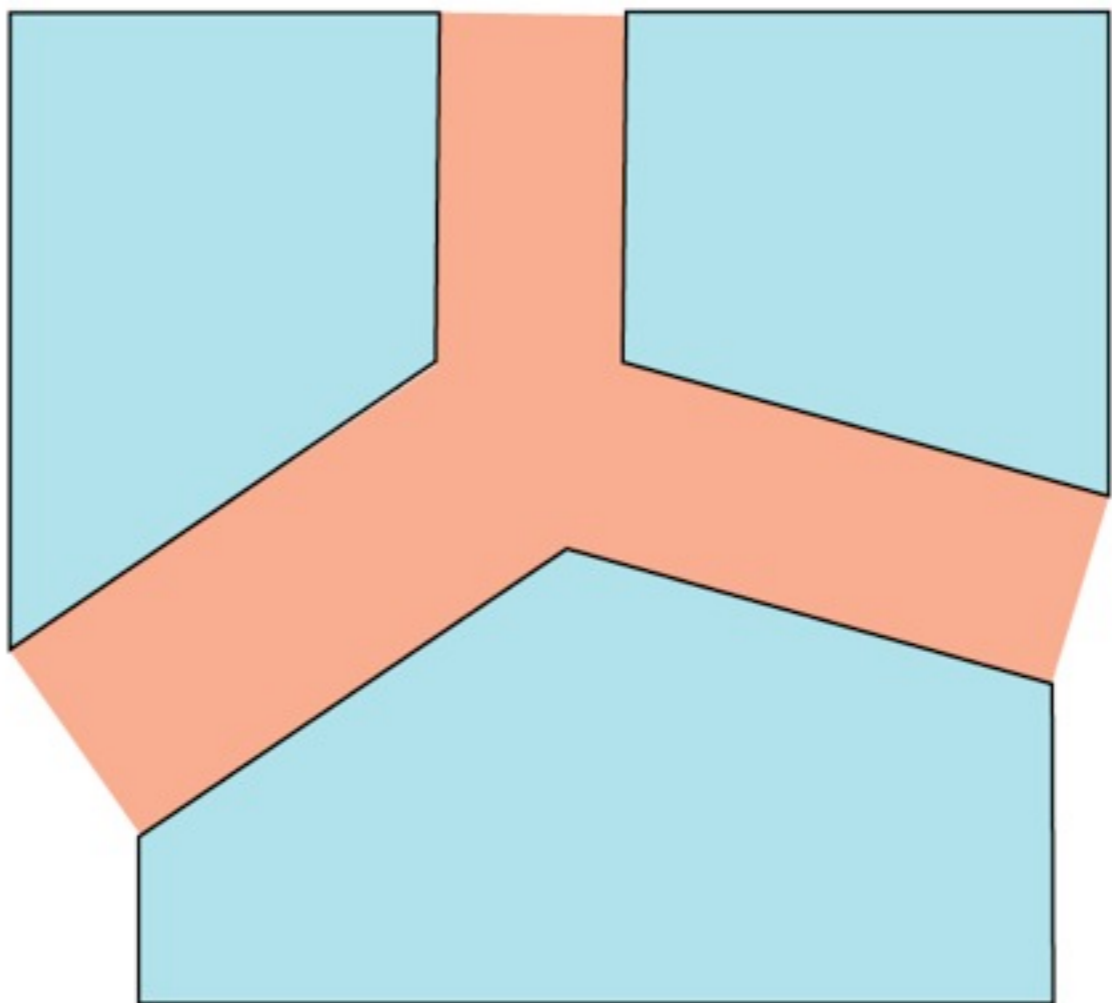

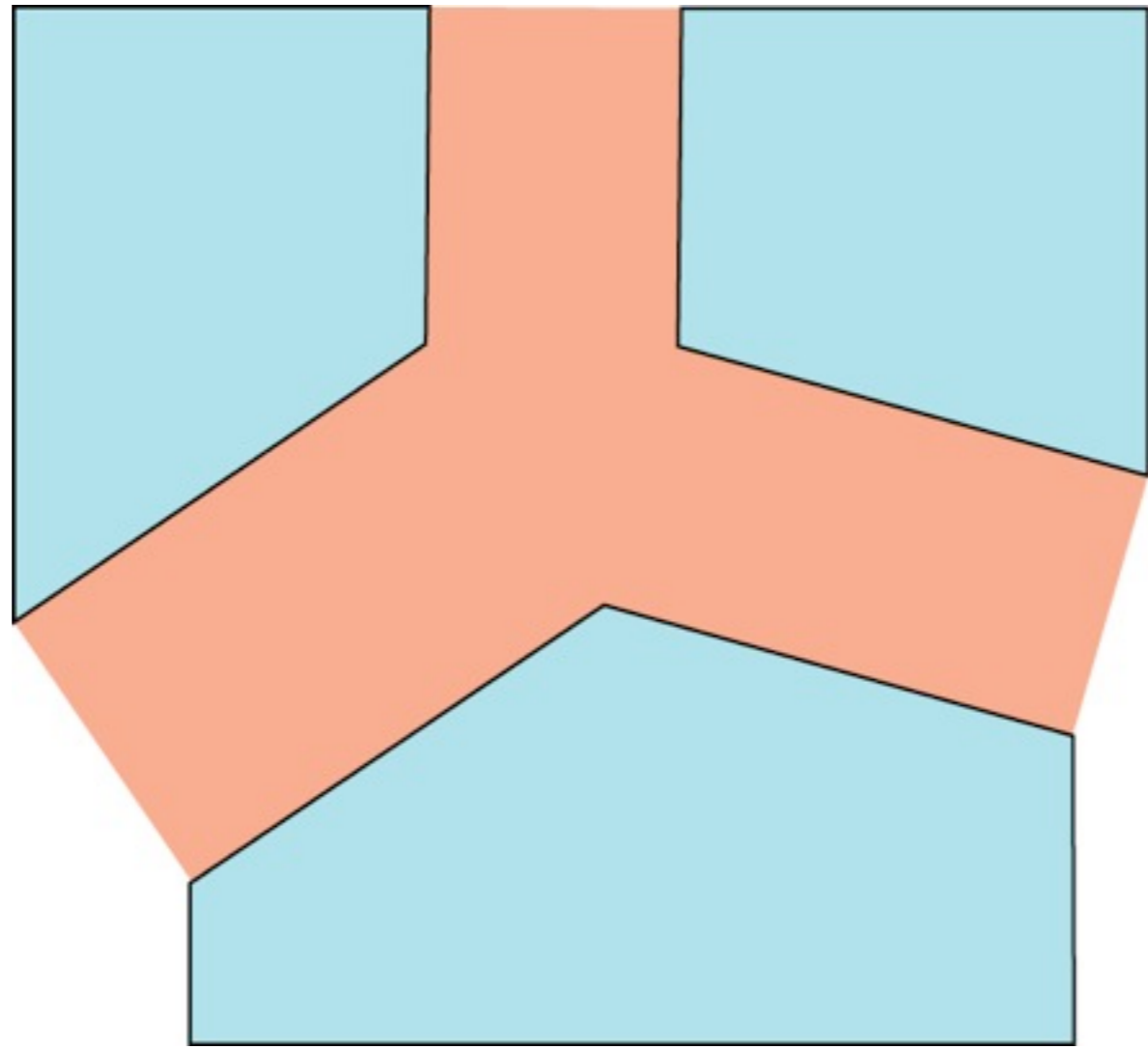



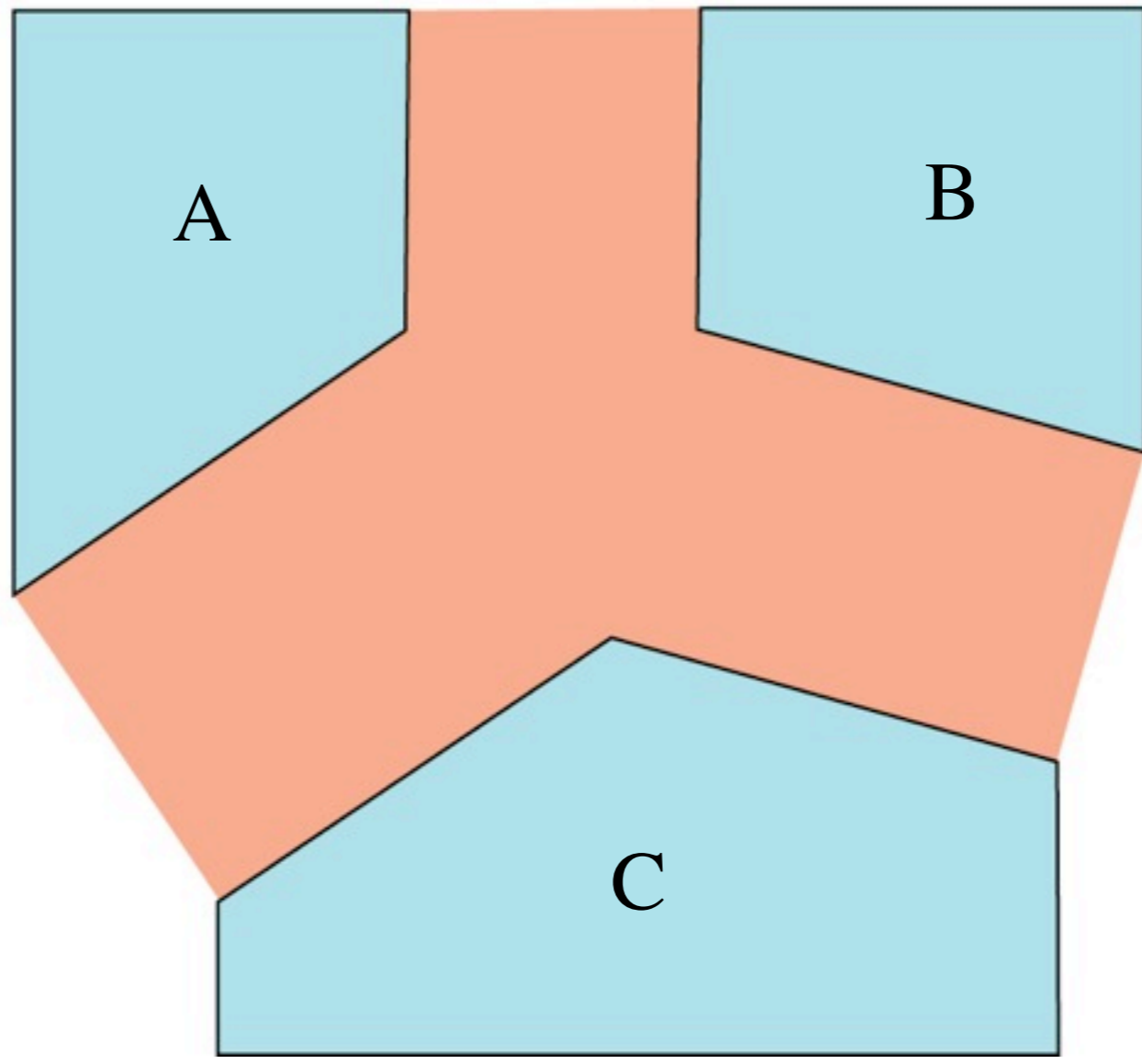

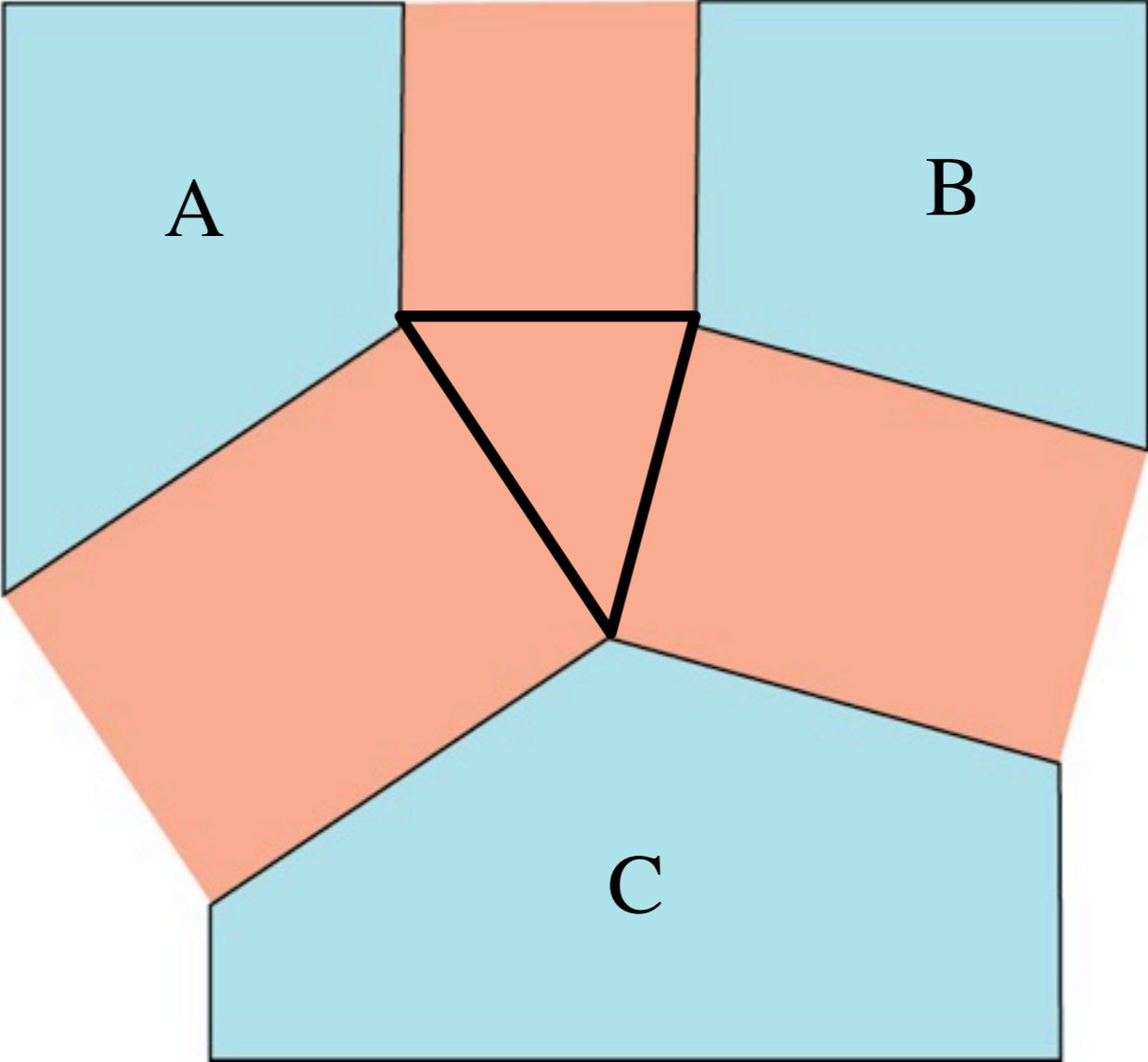



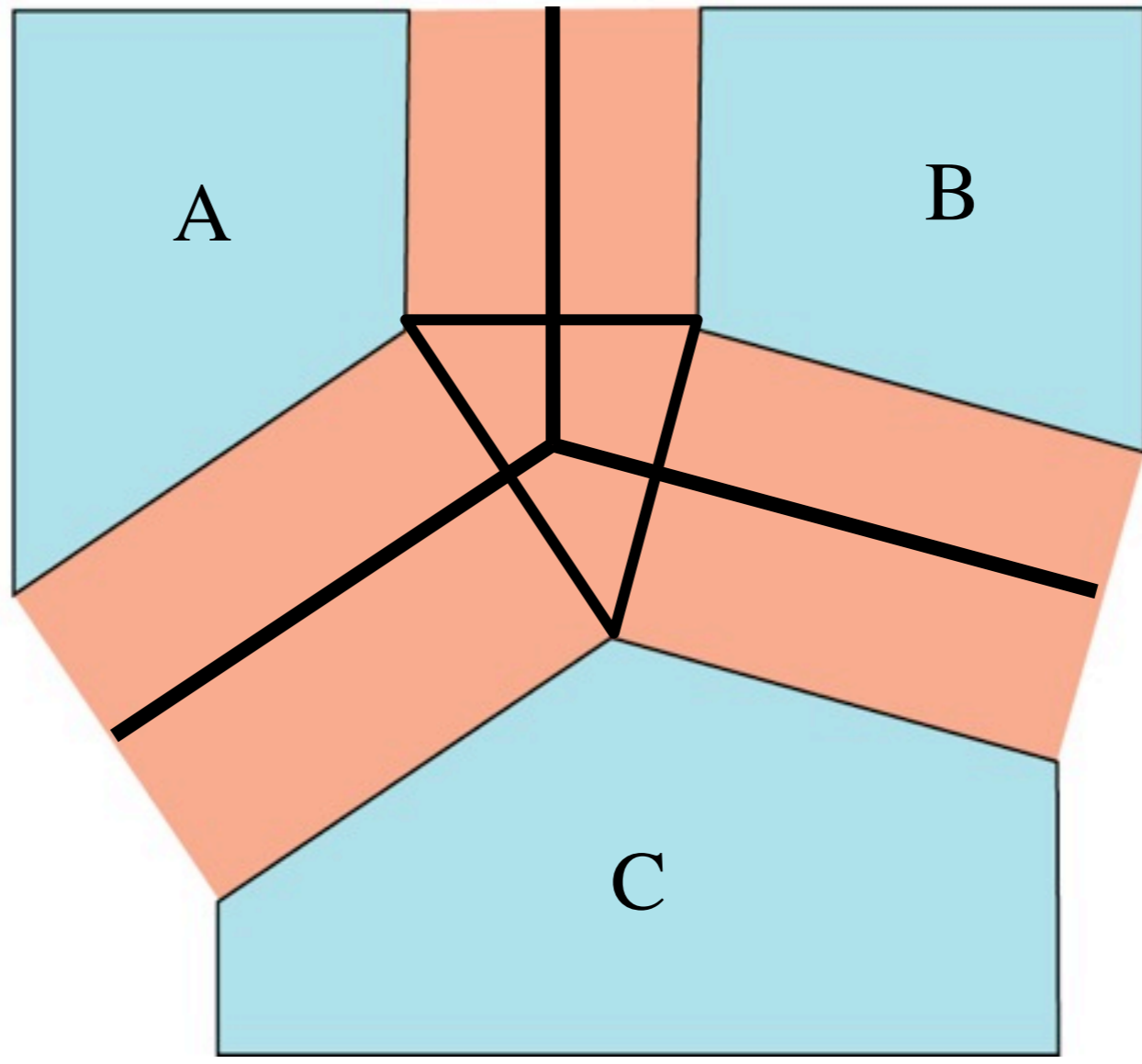

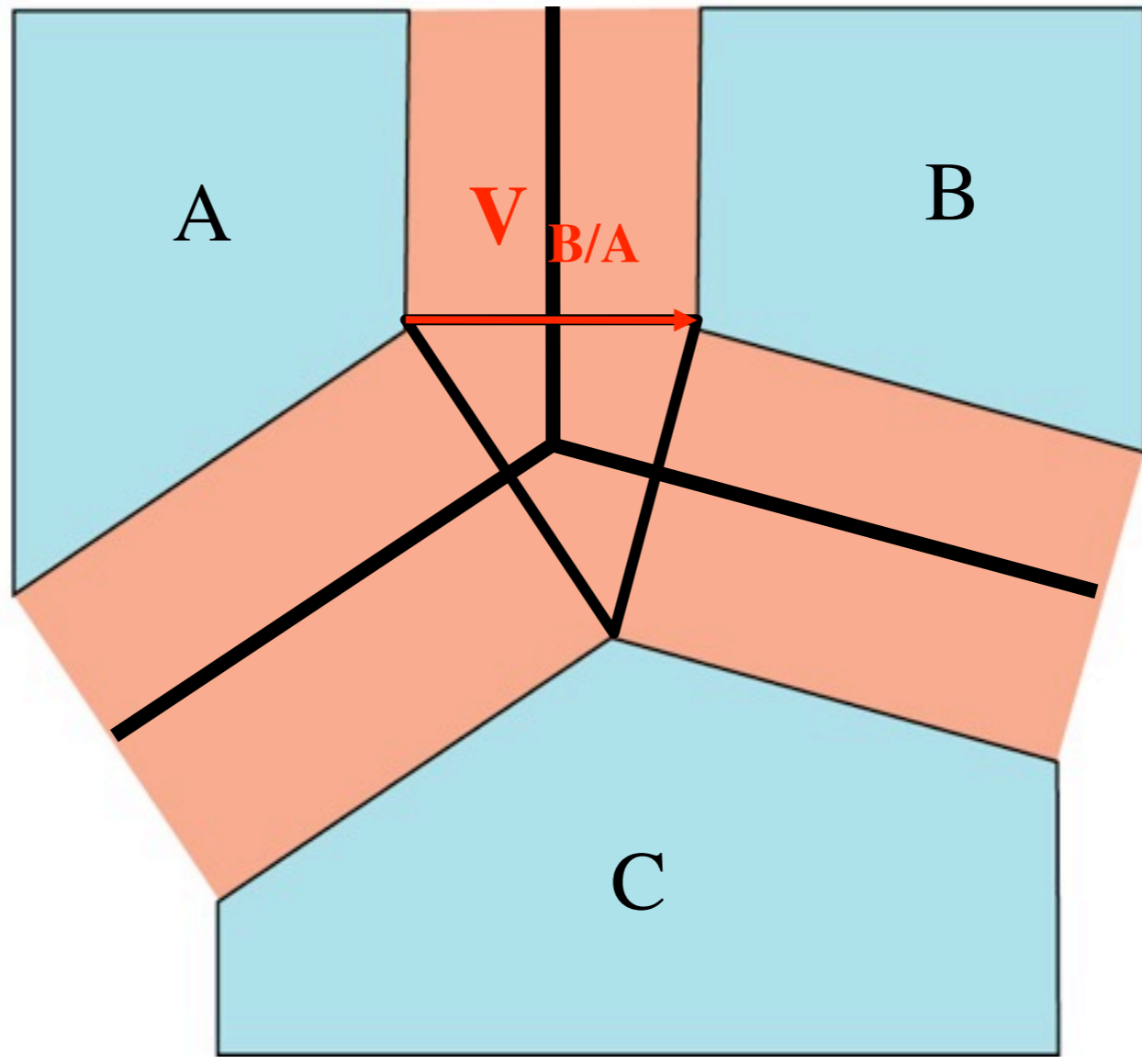



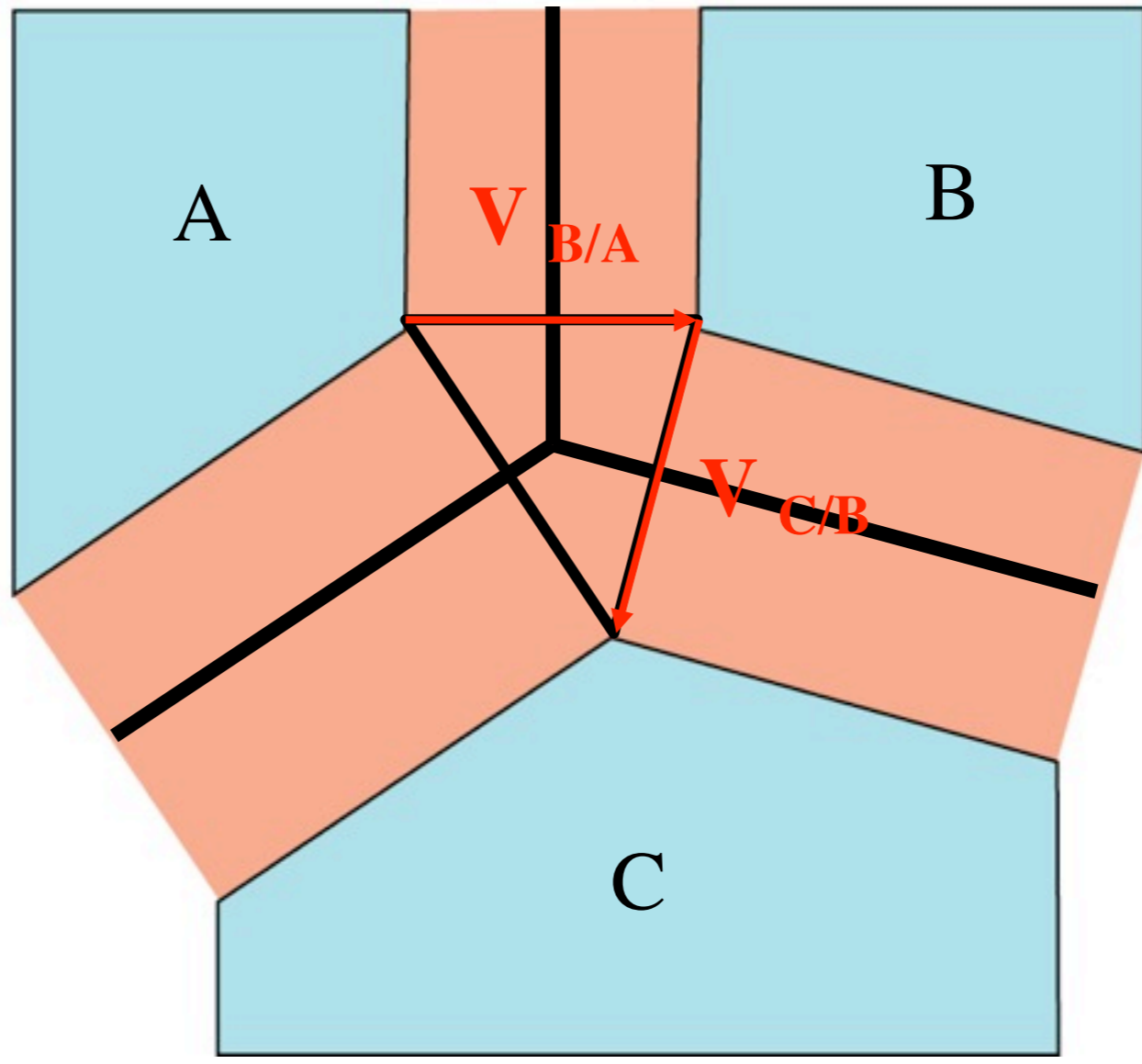

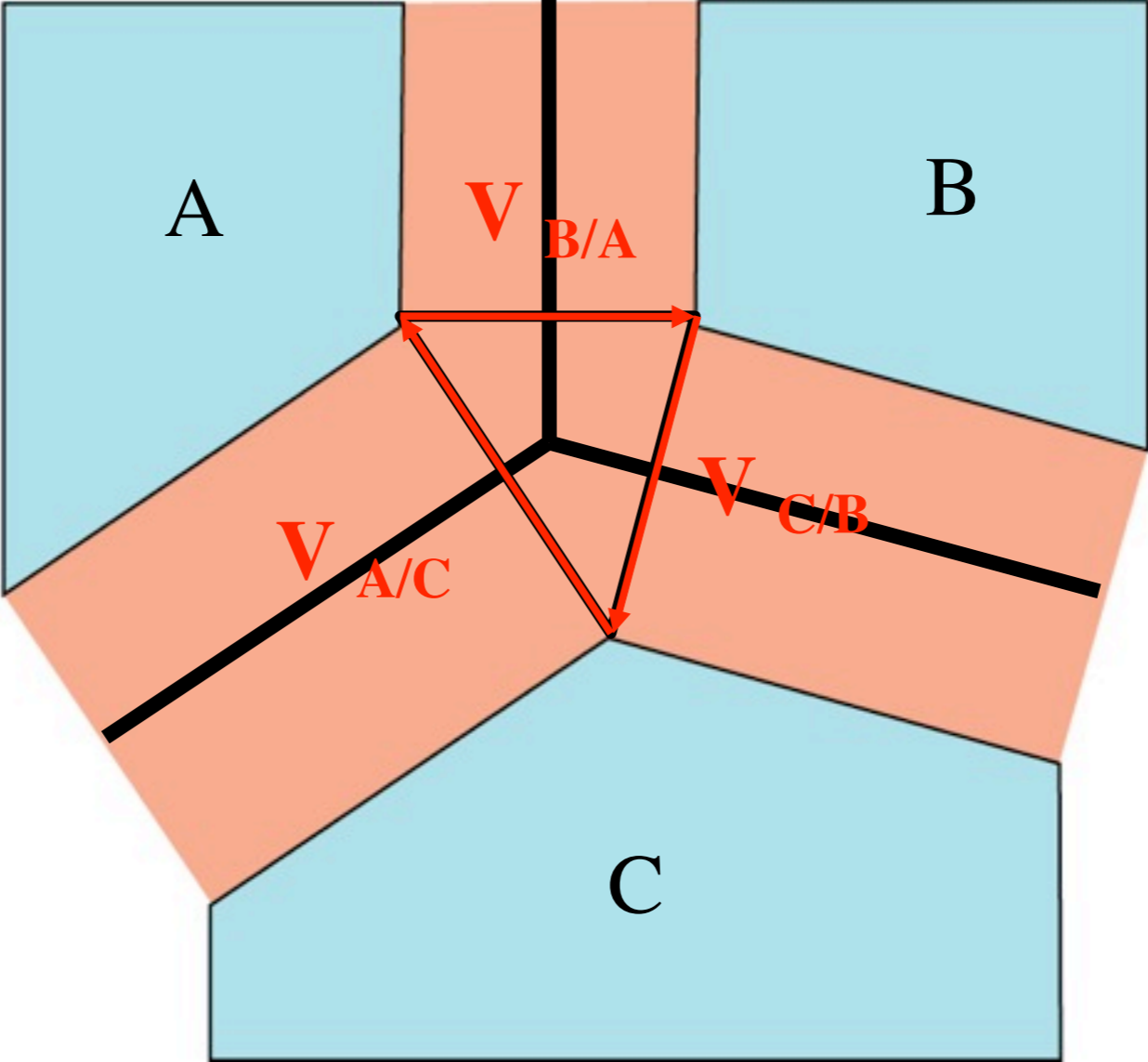



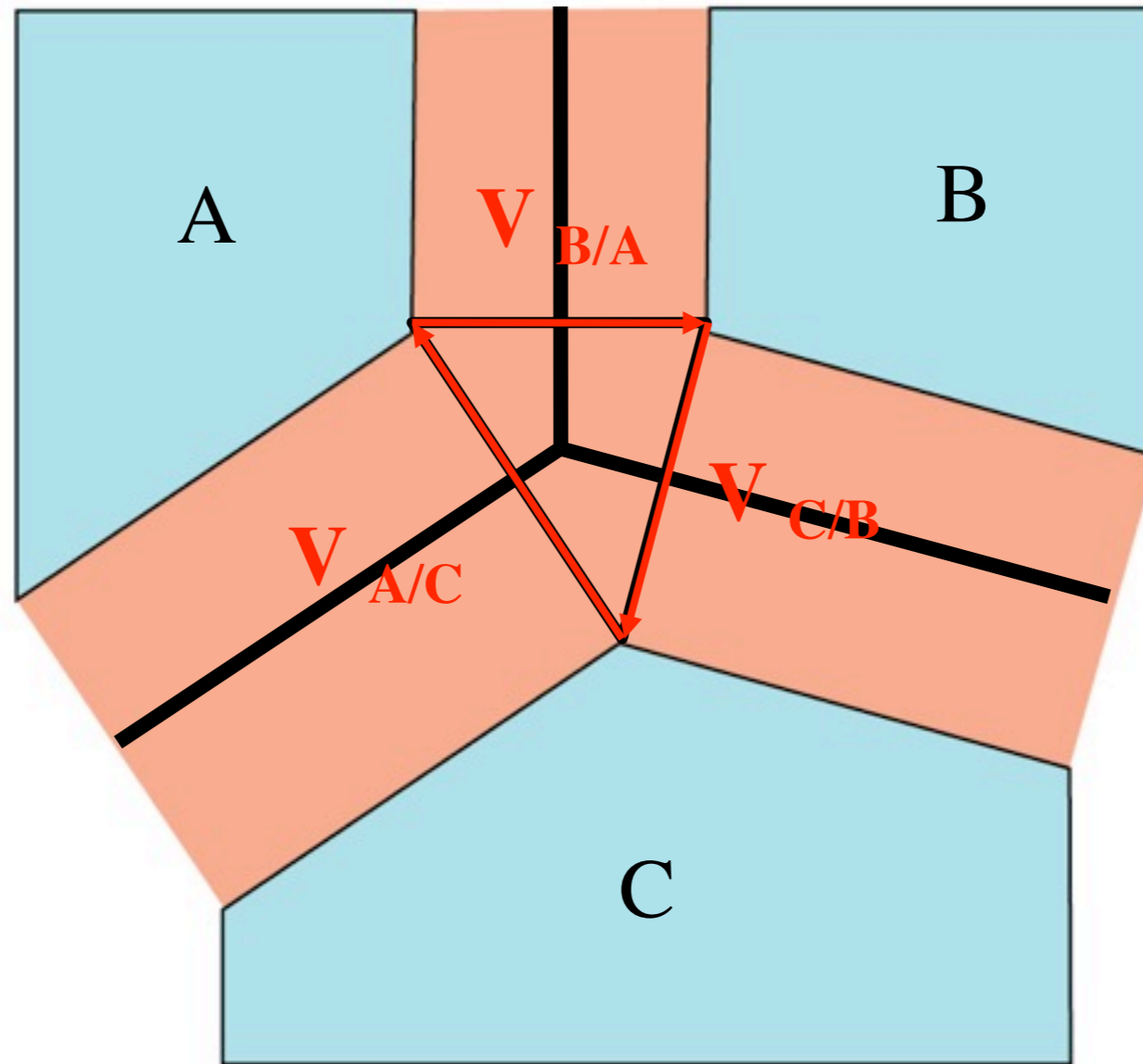

**Triangle des vitesses**

# Points triples et rigidité

## JONCTION TRIPLE DE TROIS RIDES (RRR)

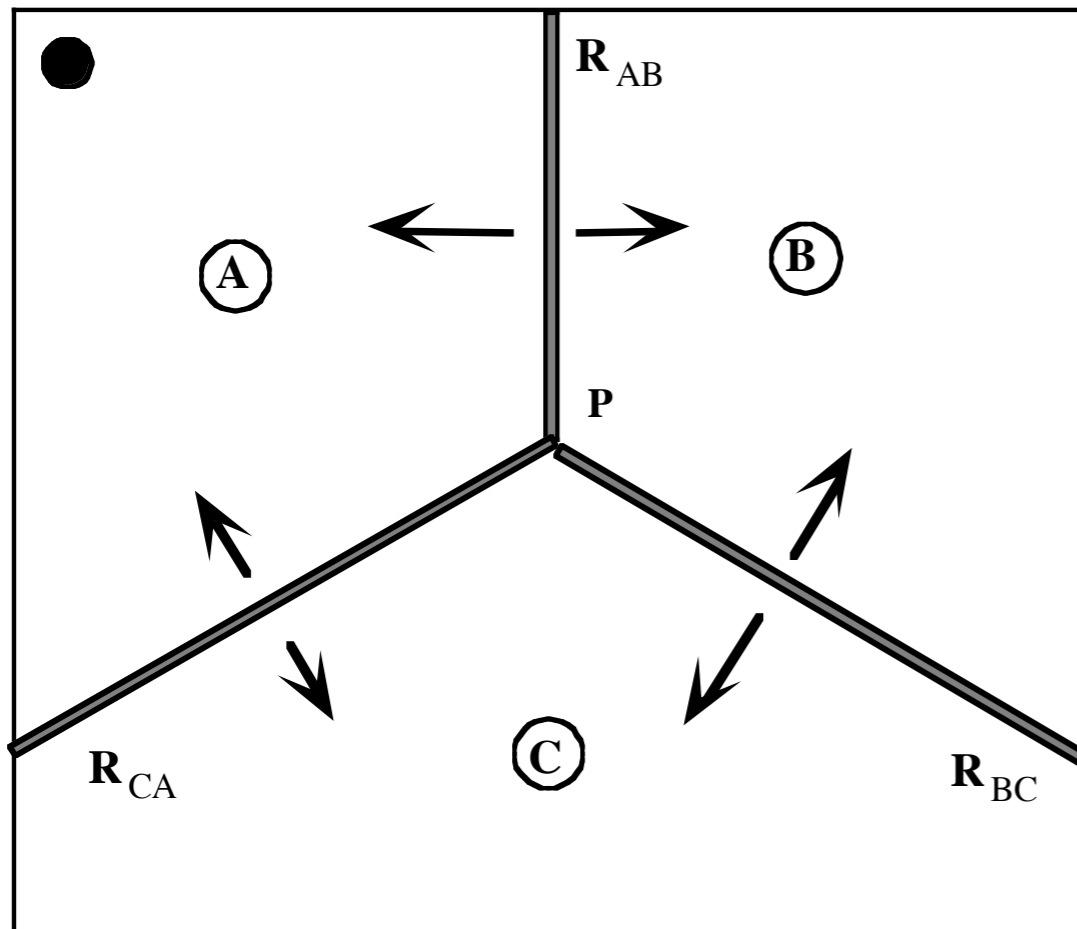

REPRESENTATION CARTOGRAPHIQUE

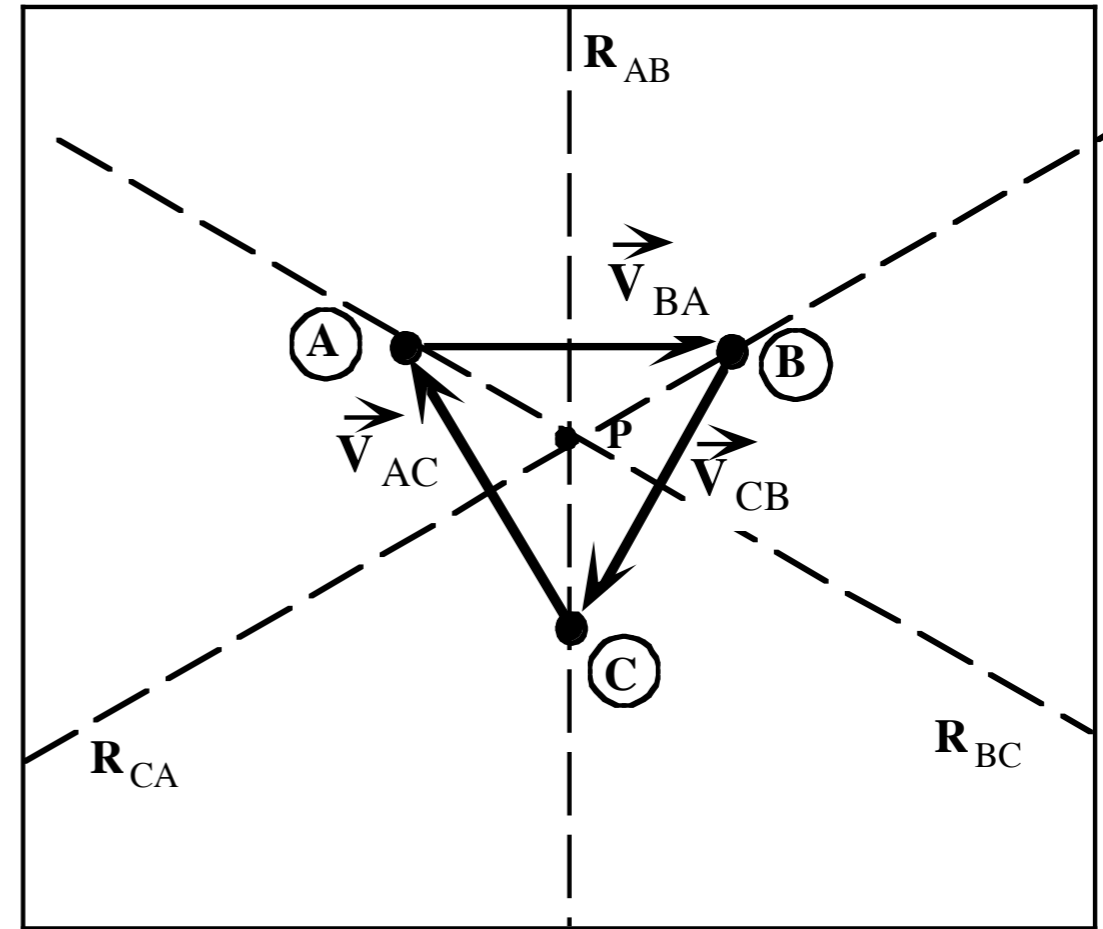

ESPACE DES VITESSES

- La rigidité impose que  $v_{AC} + v_{BA} + v_{CB} = 0$
- Or  $v = \omega \wedge r$
- Donc  $\omega_{AC} + \omega_{BA} + \omega_{CB} = 0$



### Mendocino

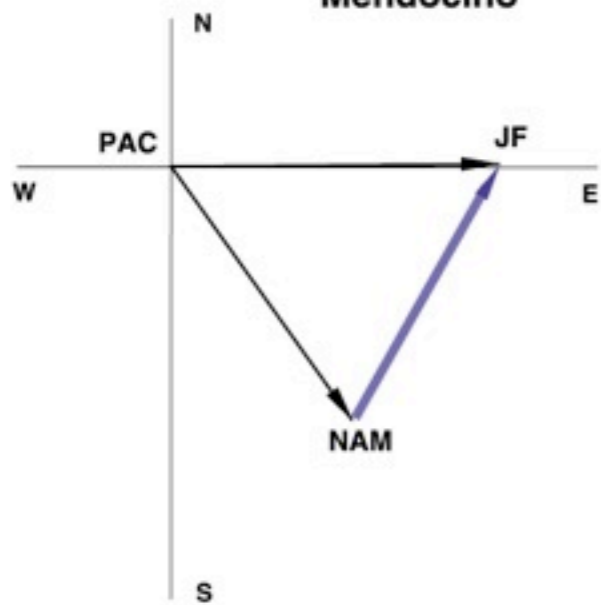

### migration

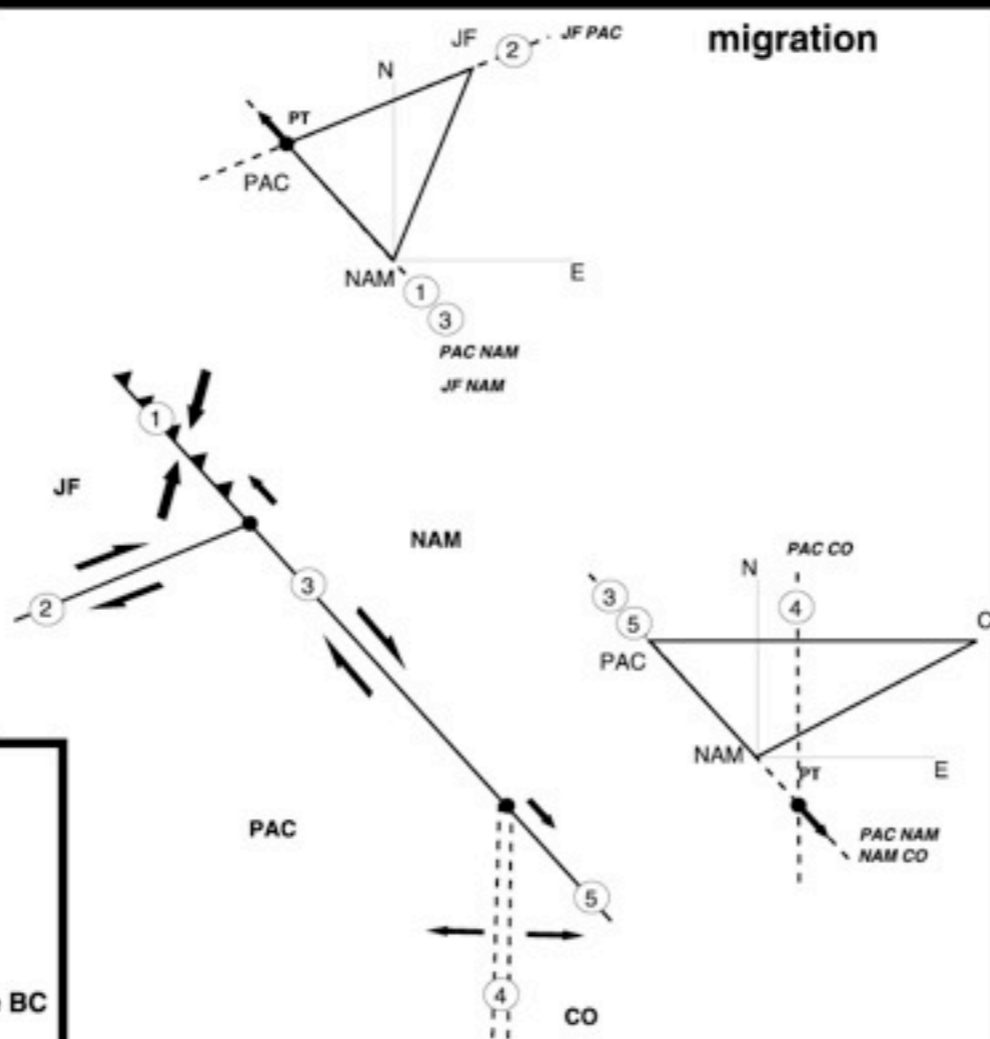

### Ride-Ride-Ride

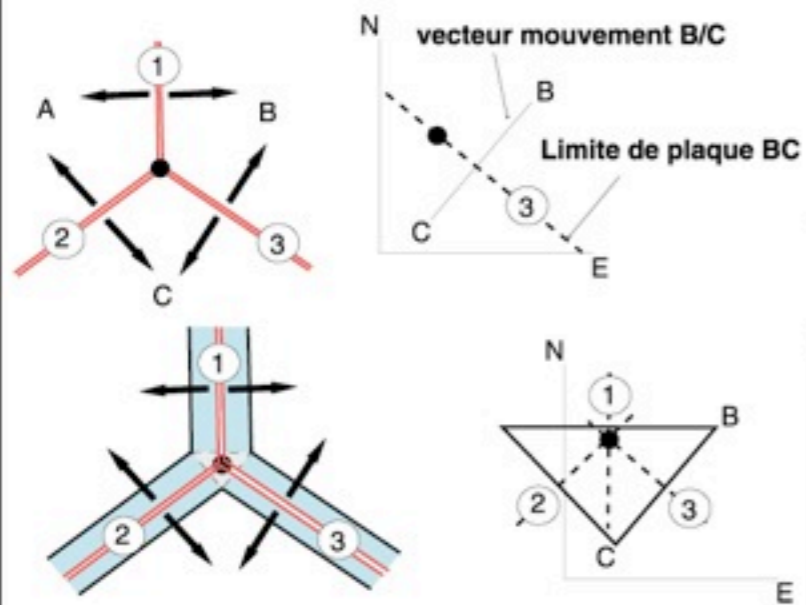

### Instabilité

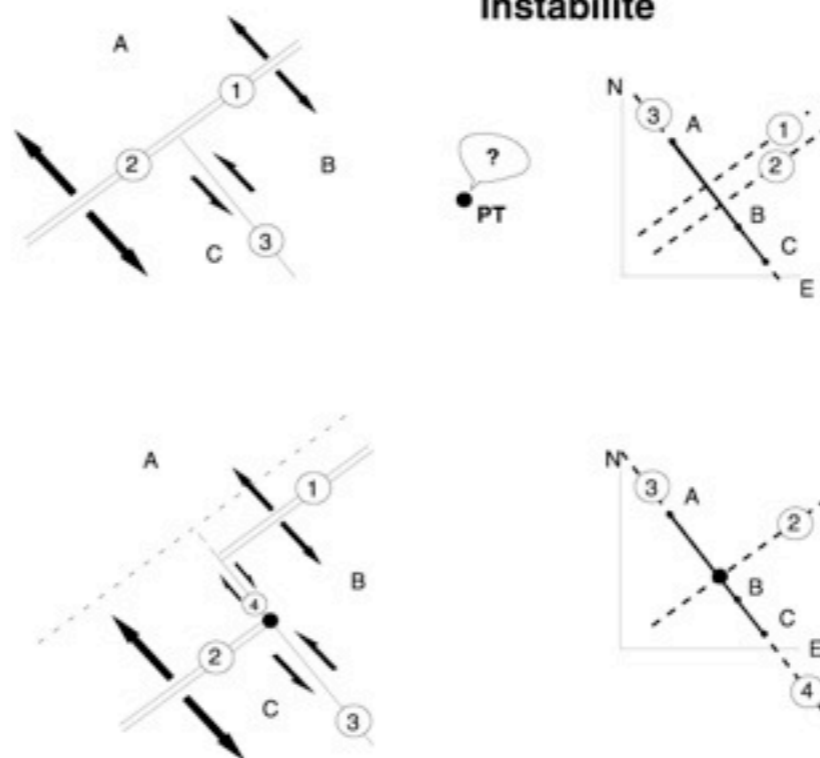

80 Ma

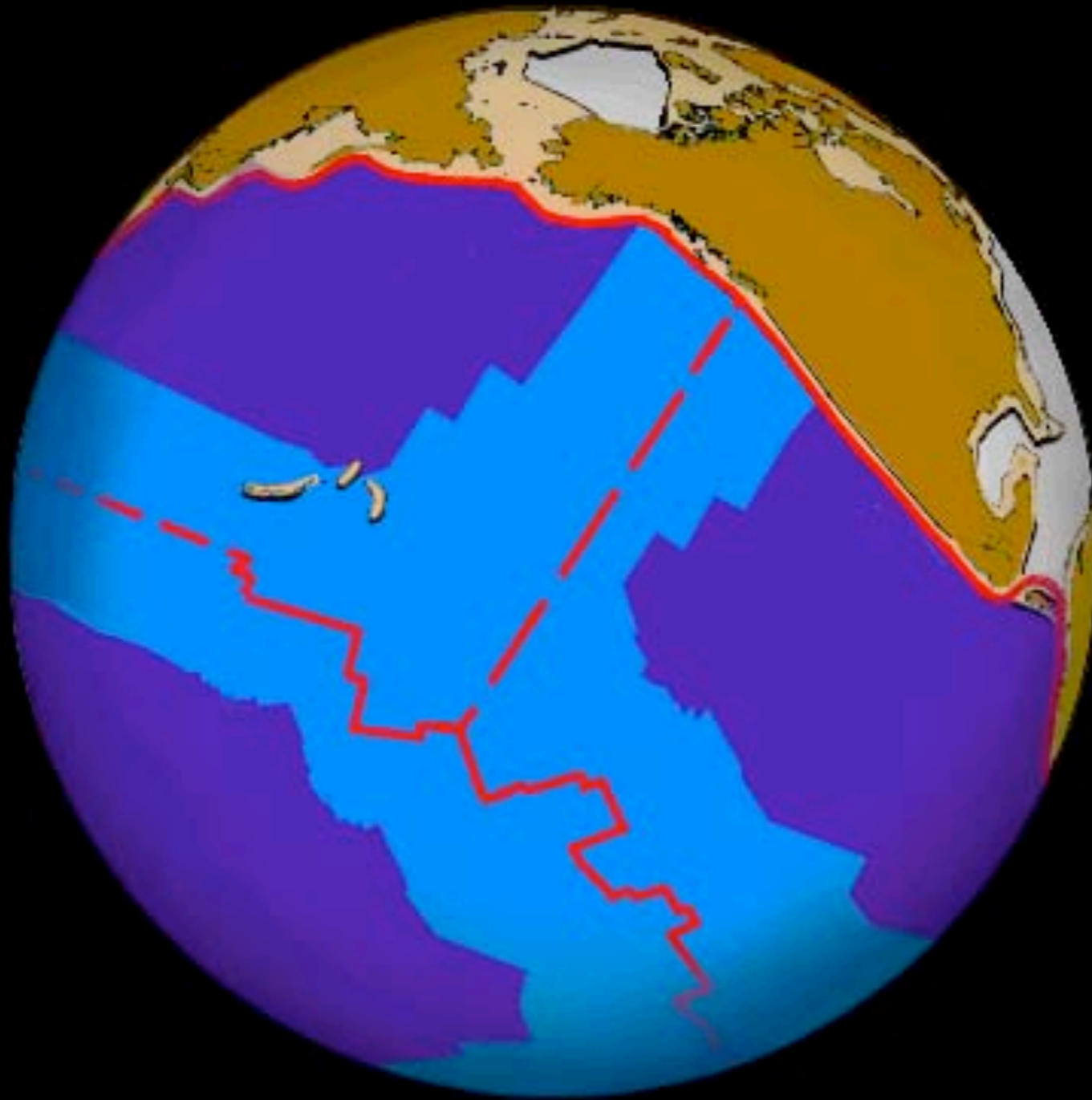



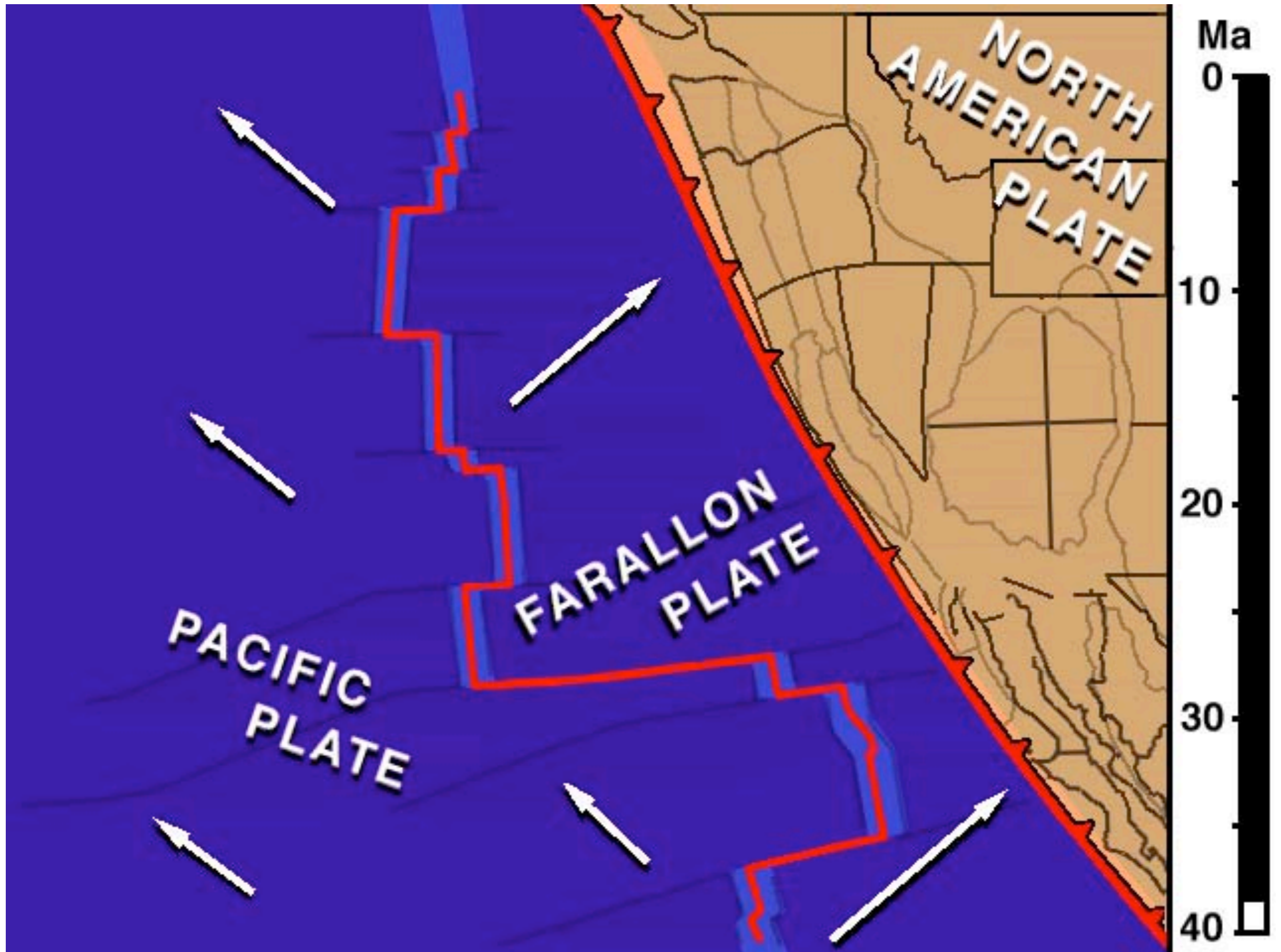

T. Atwater: <http://www.geol.ucsb.edu/Outreach/Download/Freeware-FR.html>

cinématique à  $n$  plaques

*Les modèles globaux*



X. Le Pichon propose le premier modèle global quantifié en vitesses et directions de mouvement

# Sea-Floor Spreading and Continental Drift<sup>1</sup>

XAVIER LE PICHON<sup>2</sup>

*Lamont Geological Observatory, Columbia University  
Palisades, New York 10962*

A geometrical model of the surface of the earth is obtained in terms of rigid blocks in relative motion with respect to each other. With this model a simplified but complete and consistent picture of the global pattern of surface motion is given on the basis of data on sea-floor spreading. In particular, the vectors of differential movement in the 'compressive' belts are computed. An attempt is made to use this model to obtain a reconstruction of the history of spreading during the Cenozoic era. This history of spreading follows closely one previously advocated to explain the distribution of sediments in the oceans.

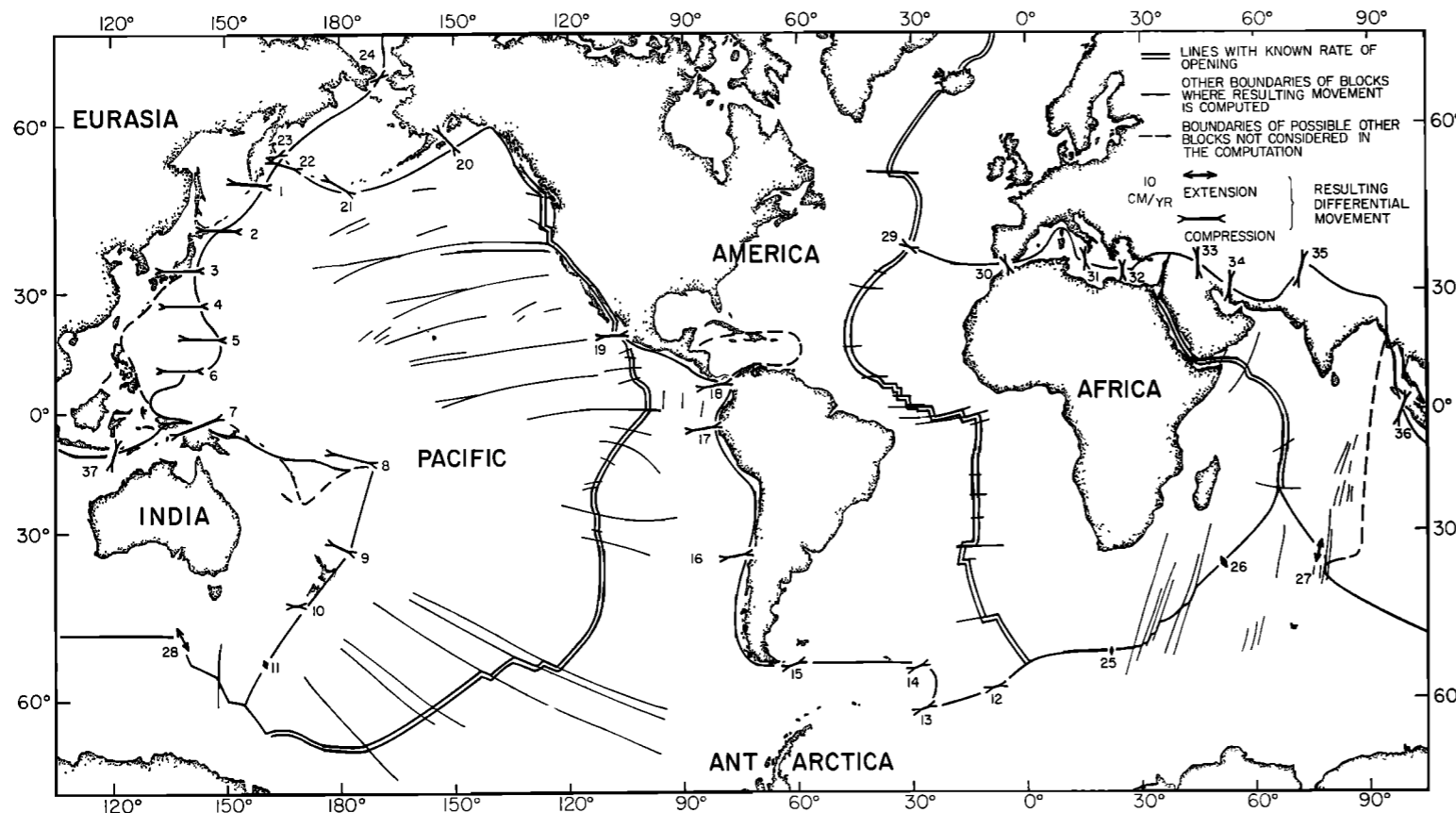

Fig. 6. The locations of the boundaries of the six blocks used in the computations. The numbers next to the vectors of differential movement refer to Table 5. Note that the boundaries where the rate of shortening or slippage exceeds about 2 cm/yr account for most of the world earthquake activity.



Scanned at the American Institute of Physics

Isacks, Oliver et Sykes montrent  
que les observations des  
sismologues confortent le  
modèle de la tectonique des  
plaques

# Seismology and the New Global Tectonics<sup>1</sup>

BRYAN ISACKS AND JACK OLIVER

*Lamont Geological Observatory, Columbia University, Palisades, New York 10964*

LYNN R. SYKES<sup>2</sup>

*Earth Sciences Laboratories, ESSA*

*Lamont Geological Observatory, Columbia University, Palisades, New York 10964*

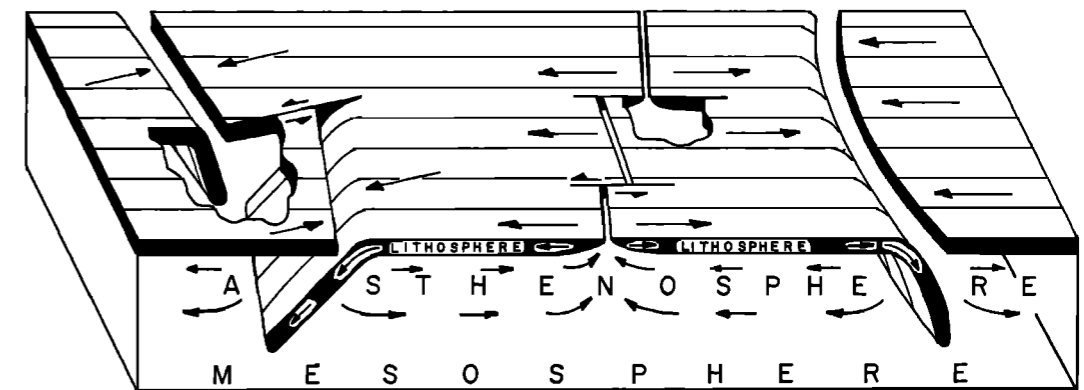
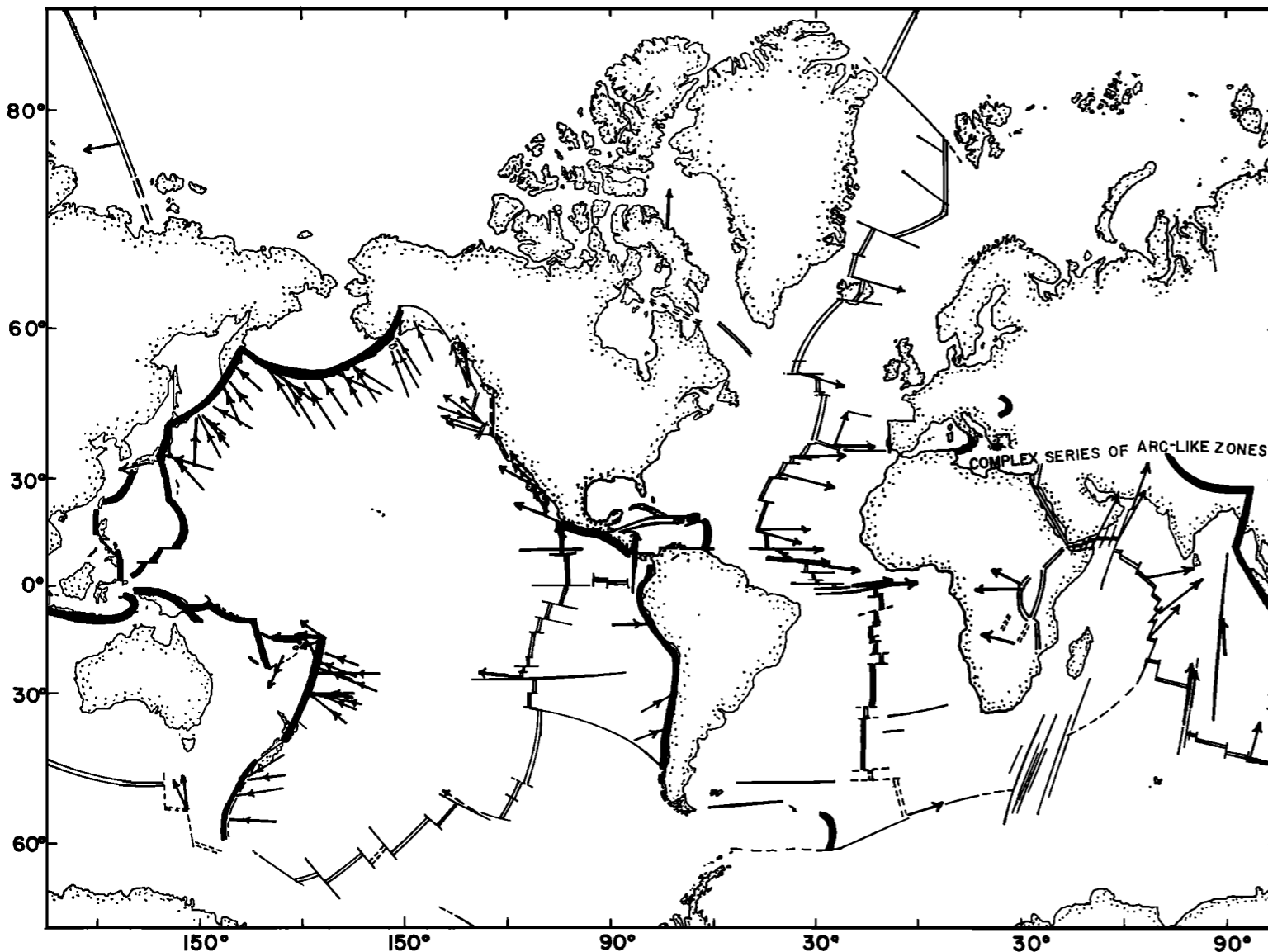

Fig. 1. Block diagram illustrating schematically the configurations and roles of the lithosphere, asthenosphere, and mesosphere in a version of the new global tectonics in which the lithosphere, a layer of strength, plays a key role. Arrows on lithosphere indicate relative movements of adjoining blocks. Arrows in asthenosphere represent possible compensating flow in response to downward movement of segments of lithosphere. One arc-to-arc transform fault appears at left between oppositely facing zones of convergence (island arcs), two ridge-to-ridge transform faults along ocean ridge at center, simple arc structure at right.



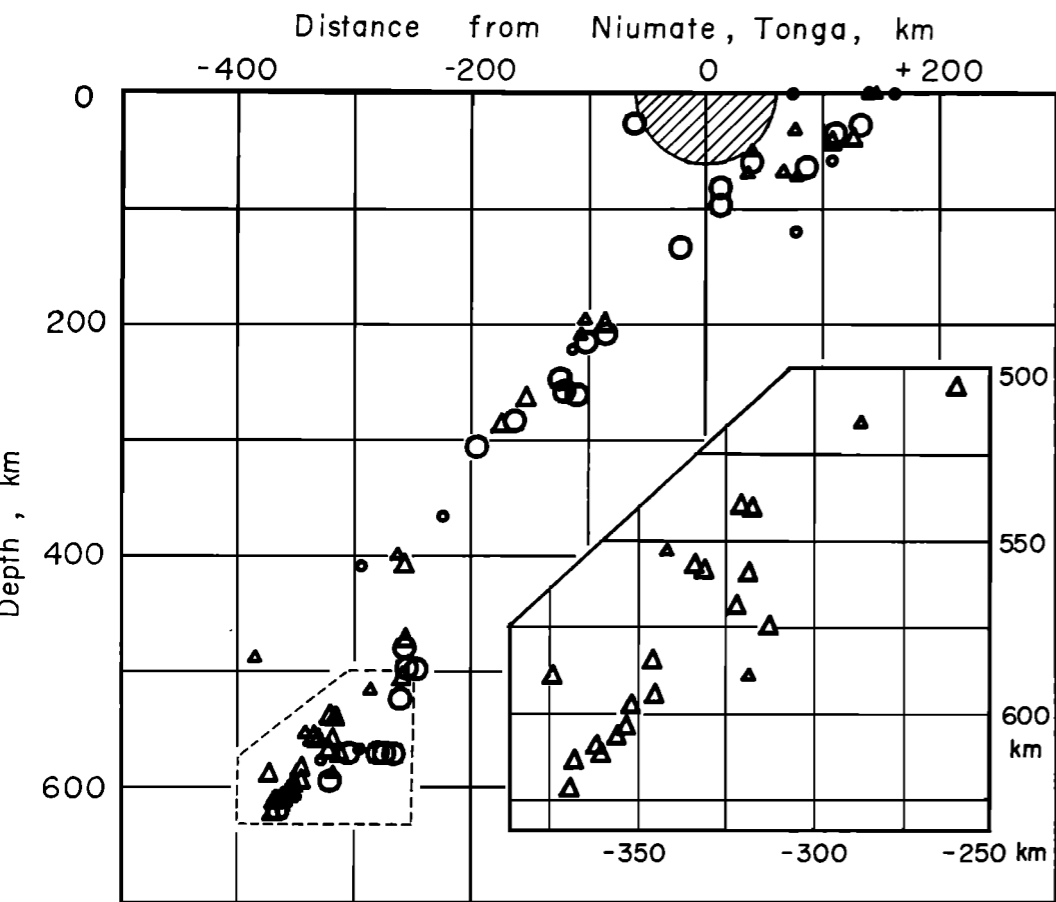
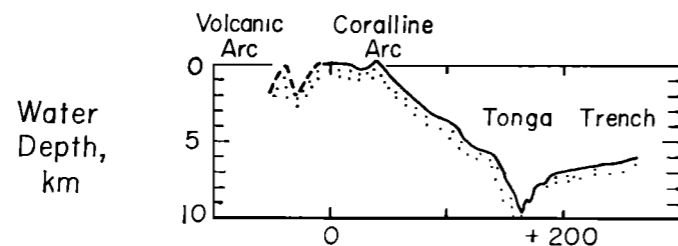

Fig. 9. Vertical section oriented perpendicular to the Tonga arc. Circles represent earthquakes projected from within 0 to 150 km north of the section; triangles correspond to events projected from within 0 to 150 km south of the section. All shocks occurred during 1965 while the Lamont network of stations in Tonga and Fiji was in operation. Locations are based on data from these stations and from more distant stations. No microearthquakes from a sample of 750 events originated from within the hatched region near the station at Niuate, Tonga (i.e., for  $S-P$  times less than 6.5 sec). A vertical exaggeration of about 13:1 was used for the insert showing the topography [after Raitt *et al.*, 1955]; the horizontal and vertical scales are equal in the cross section depicting earthquake locations. Lower insert shows enlargement of southern half of section for depths between 500 and 625 km. Note small thickness (less than ~20 km) of seismic zone for wide range of depths.

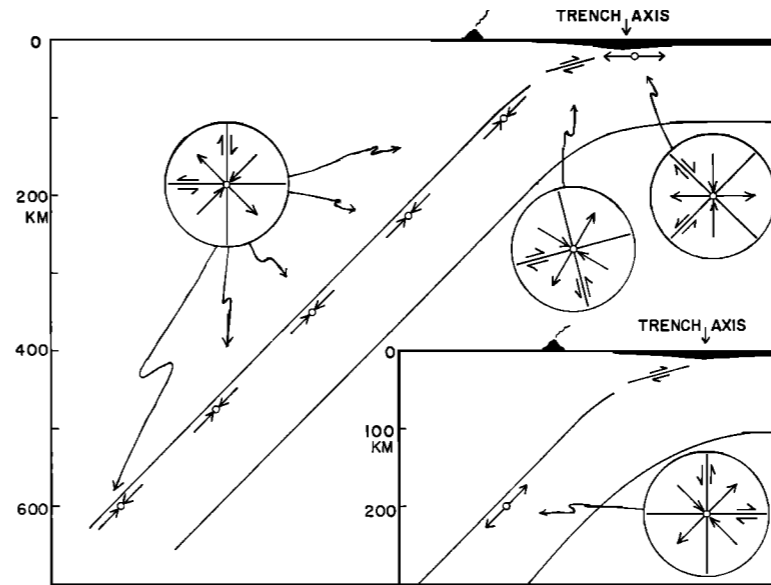

Fig. 11. Vertical sections perpendicular to the strike of an island arc showing schematically typical orientations of double-couple focal mechanisms. The horizontal scale is the same as the vertical scale. The axis of compression is represented by a converging pair of arrows; the axis of tension is represented by a diverging pair; the null axis is perpendicular to the section. In the circular blowups, the sense of motion is shown for both of the two possible slip planes. The features shown in the main part of the figure are based on results from the Tonga arc and the arcs of the North Pacific. The insert shows the orientation of a focal mechanism that could indicate extension instead of compression parallel to the dip of the zone.

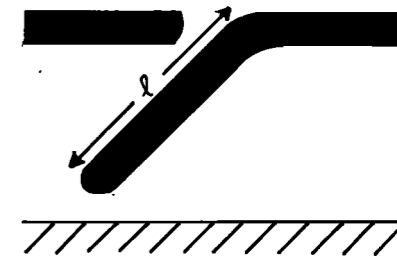

Fig. 14a. Length  $l$  is a measure of the amount of underthrusting during the most recent period of sea-floor spreading.

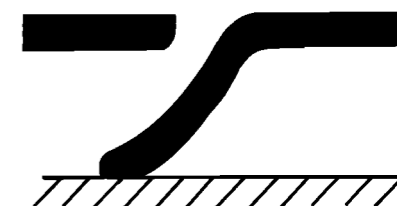

Fig. 14b. Lithosphere is deformed along its lower edge as it encounters a more resistant layer (the mesosphere).

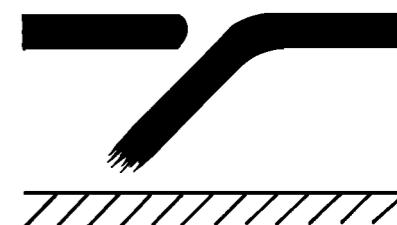

Fig. 14c. Length of seismic zone is the product of rate of underthrusting and time constant for assimilation of slab by upper mantle.

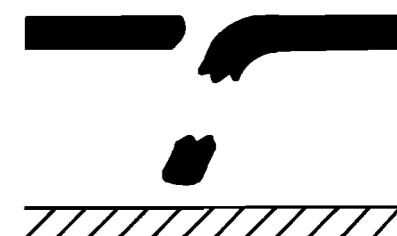

Fig. 14d. A piece (or pieces) of the lithosphere becomes detached either by gravitational sinking or by forces in the asthenosphere.

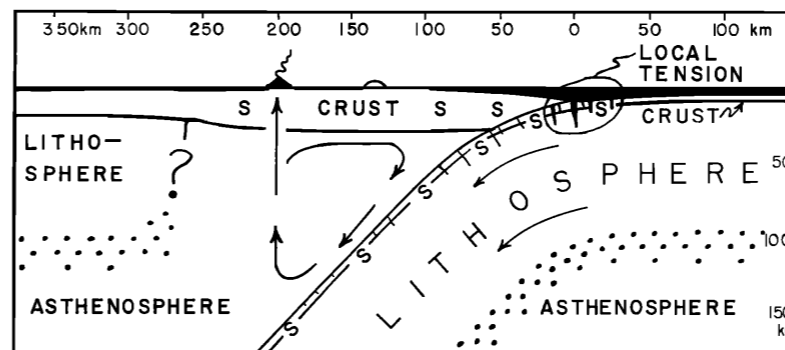

Fig. 7a.

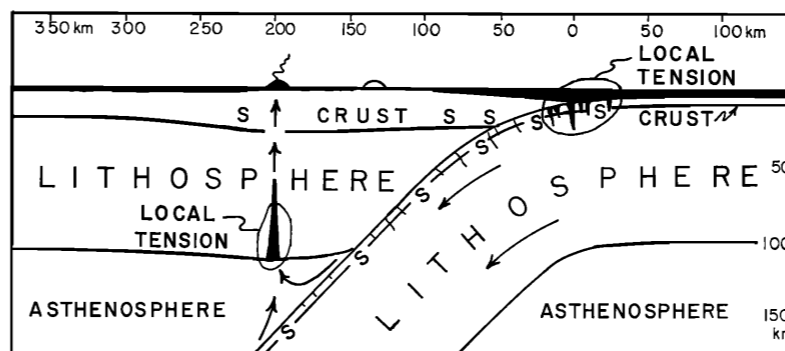

Fig. 7b.

Figure 7 shows vertical sections through an island arc indicating hypothetical structures and other features. Both sections show down-going slab of lithosphere, seismic zone near surface of slab and in adjacent crust, tensional features beneath ocean deep where slab bends abruptly and surface is free. (In both sections,  $S$  indicates seismic activity.) (a) A gap in mantle portion of lithosphere beneath island arc and circulation in mantle associated with crustal material of the slab and with adjoining mantle [Holmes, 1965]. (b) The overriding lithosphere in contact with the down-going slab and bent upward as a result of overthrusting. The relation of the bending to the volcanoes follows Gunn [1947]. No vertical exaggeration.

Figure 14 shows four possible configurations of an underthrust plate of lithosphere in island arcs. Solid areas indicate lithosphere; white area, asthenosphere; hatched area, mesosphere.

Leur article est plein d'idées nouvelles très à la mode aujourd'hui sur la dynamique de la subduction

Isacks et al., 1968

# Mountain Belts and the New Global Tectonics

JOHN F. DEWEY

Department of Geology, University of Cambridge  
Cambridge, England

JOHN M. BIRD

Department of Geological Sciences  
State University of New York at Albany  
Albany, New York 12203

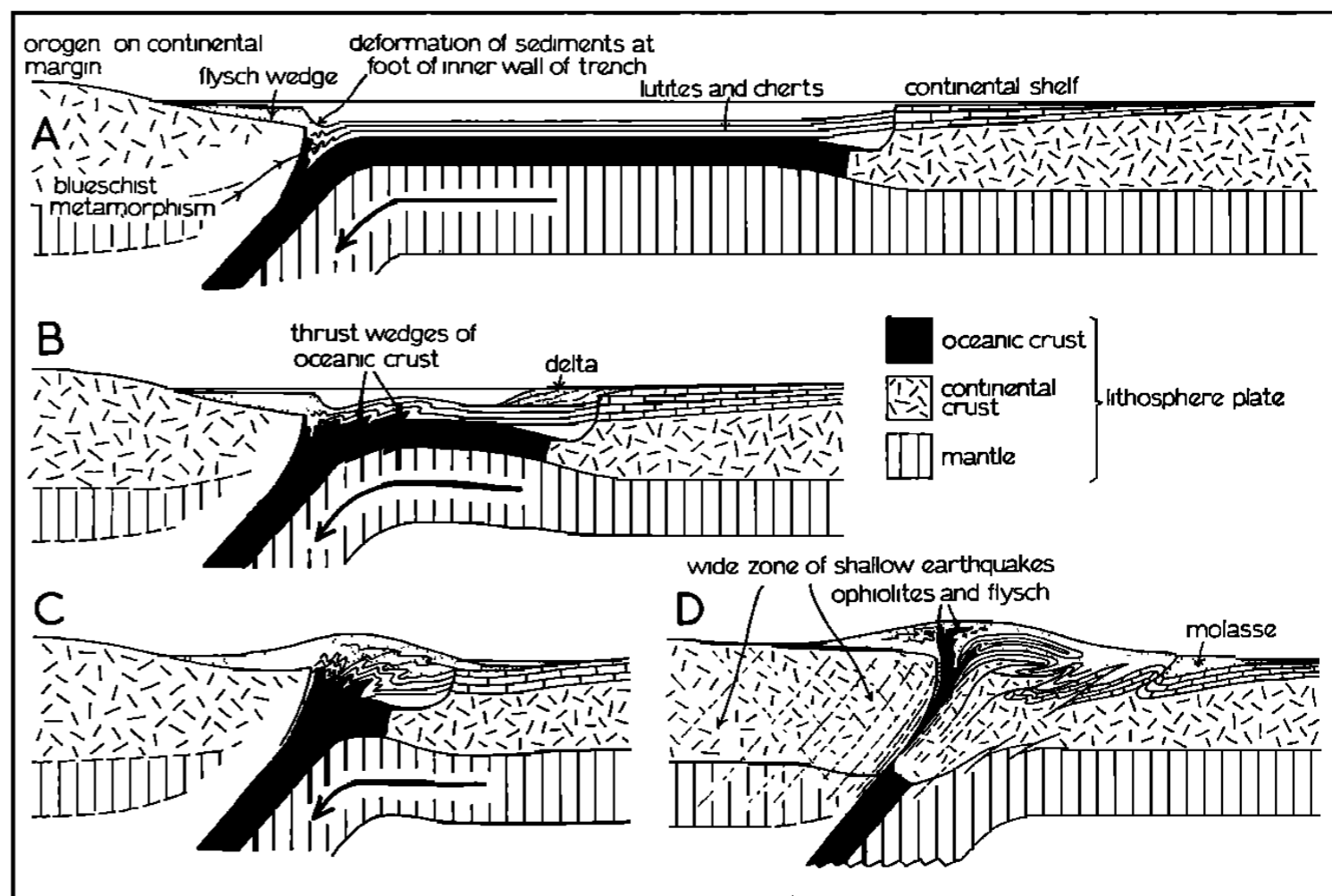
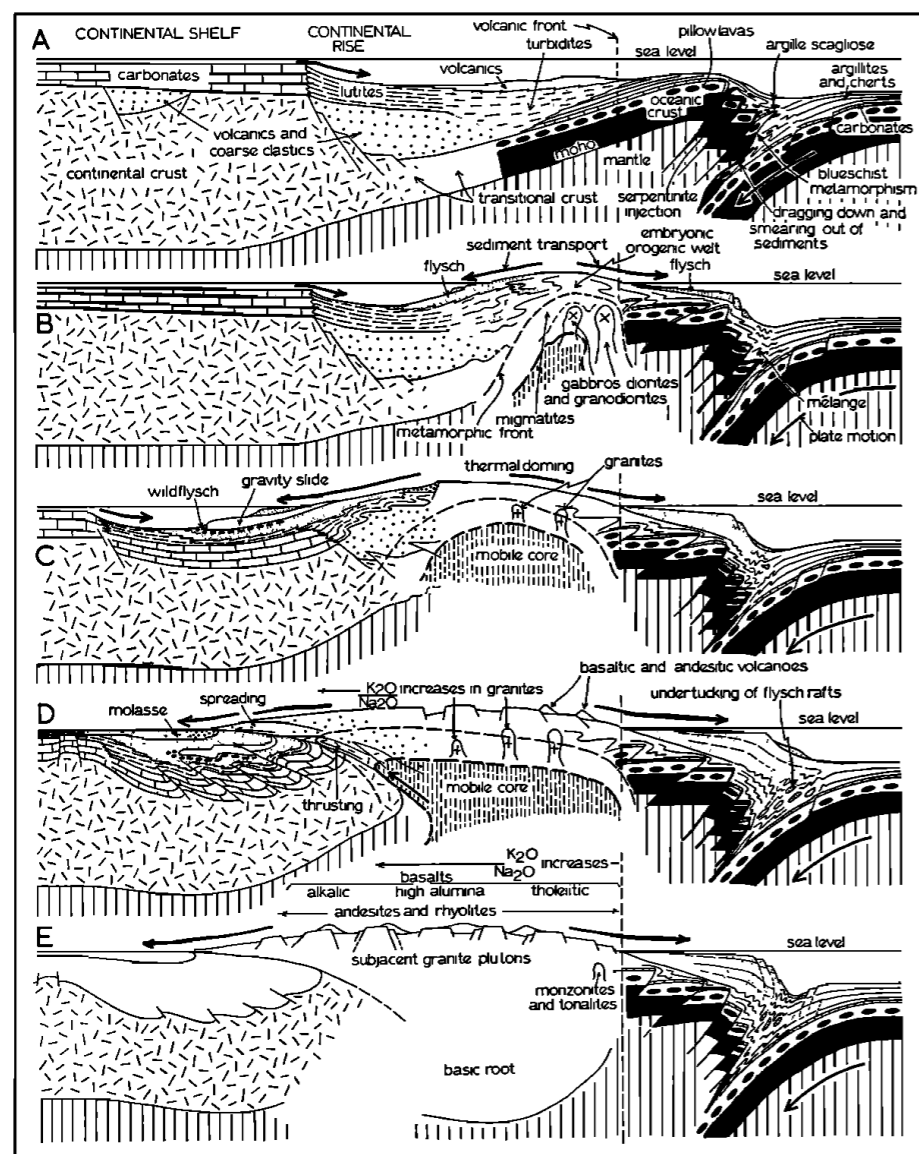

Fig. 13. Schematic sequence of sections illustrating the collision of two continents.

La nouvelle théorie est très vite mise à profit par les géologues. Ils tiennent enfin le cadre conceptuel qui leur manquait et qui est venu des océans

Fig. 10. Schematic sequence of sections illustrating a model for the evolution of a cordilleran-type mountain belt developed by the underthrusting of a continent by an oceanic plate.



# Le modèle NUVEL-1 (*DeMets et al., 1990*)

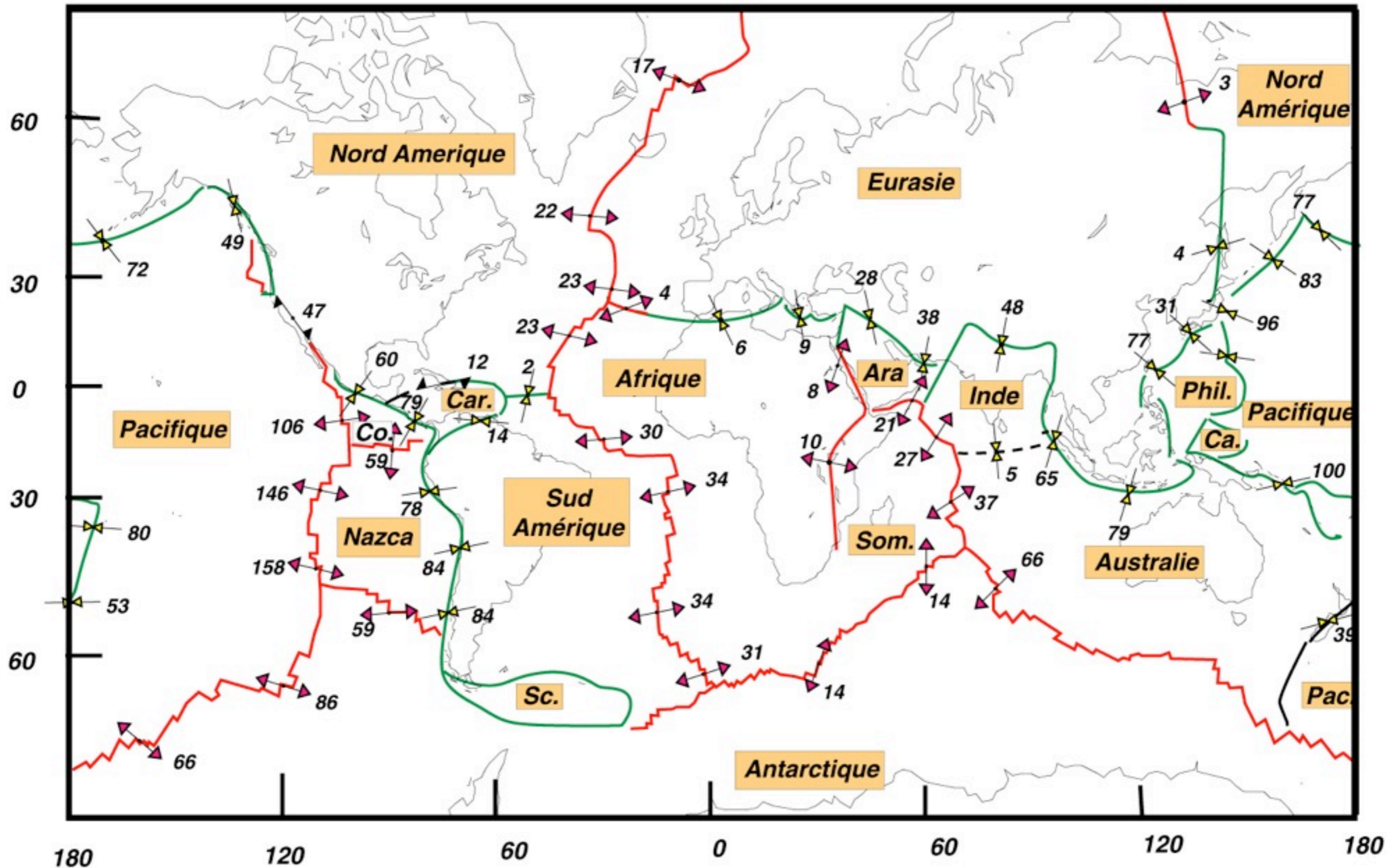



# Le modèle NUVEL-1 (*DeMets et al., 1990*)

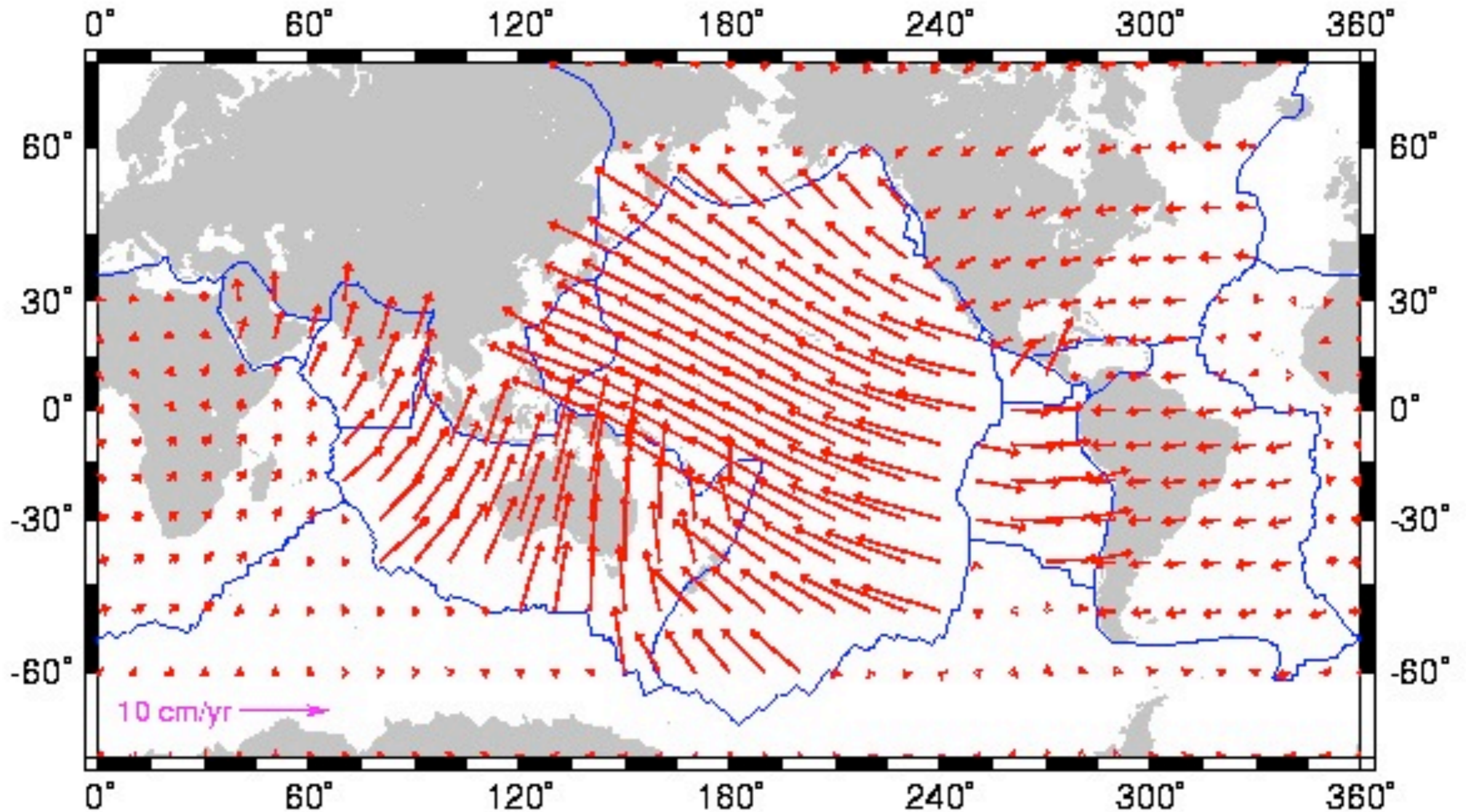

NB: tous les mouvements sont par rapport à l'Eurasie fixe



## Le renforcement du modèle par son efficacité prédictive

Le modèle prévoit que la croûte océanique est d'autant plus vieille qu'on s'éloigne de la dorsale. Les âges des sédiments en contact avec le plancher océanique (programme de forage sous-marins J.O.I.D.E.S.) confirment cette prédiction et les vitesses prévues par le modèle de la tectonique des plaques.

Le modèle prévoit des vitesses de déplacements des plaques (d'après le paléomagnétisme et les alignements de volcans intraplaques). Avec l'utilisation des techniques de positionnement par satellites (G.P.S.), à la fin du XXe siècle, les mouvements des plaques deviennent directement observables et leurs vitesses sont confirmées.

# carte des anomalies magnétiques

● sites de forage du programme DSDP

Dès le début les idées sur l'expansion des fonds océaniques sont testées par des forages. C'est le programme DSDP

Extrait d'un cours de Cornell Univ.

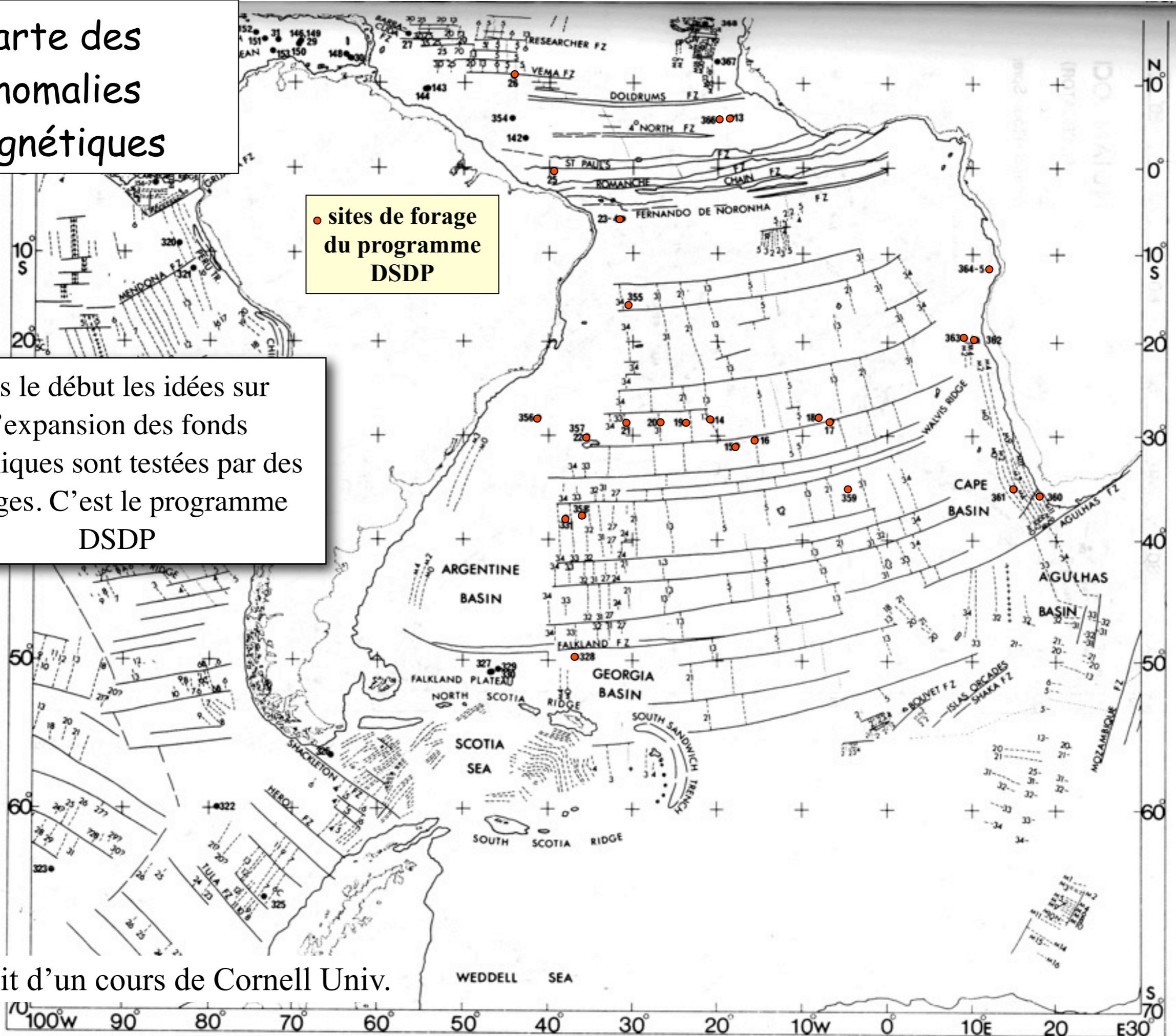



# Forages profonds dans l'Atlantique (DSDP)

## anomalie magnétique

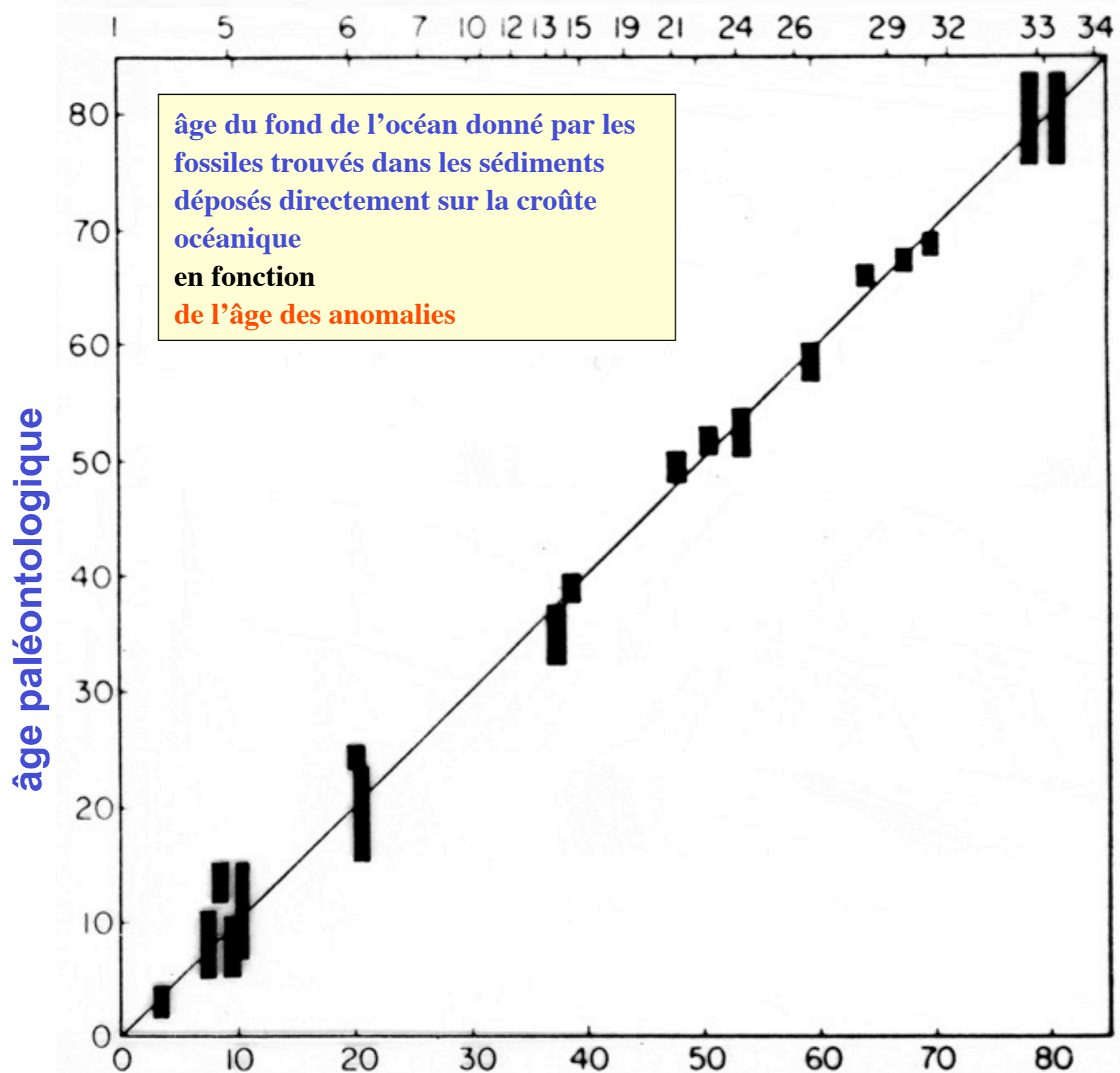

Age (Ma) des anomalies en supposant une vitesse constante

# L'âge du fonds des océans

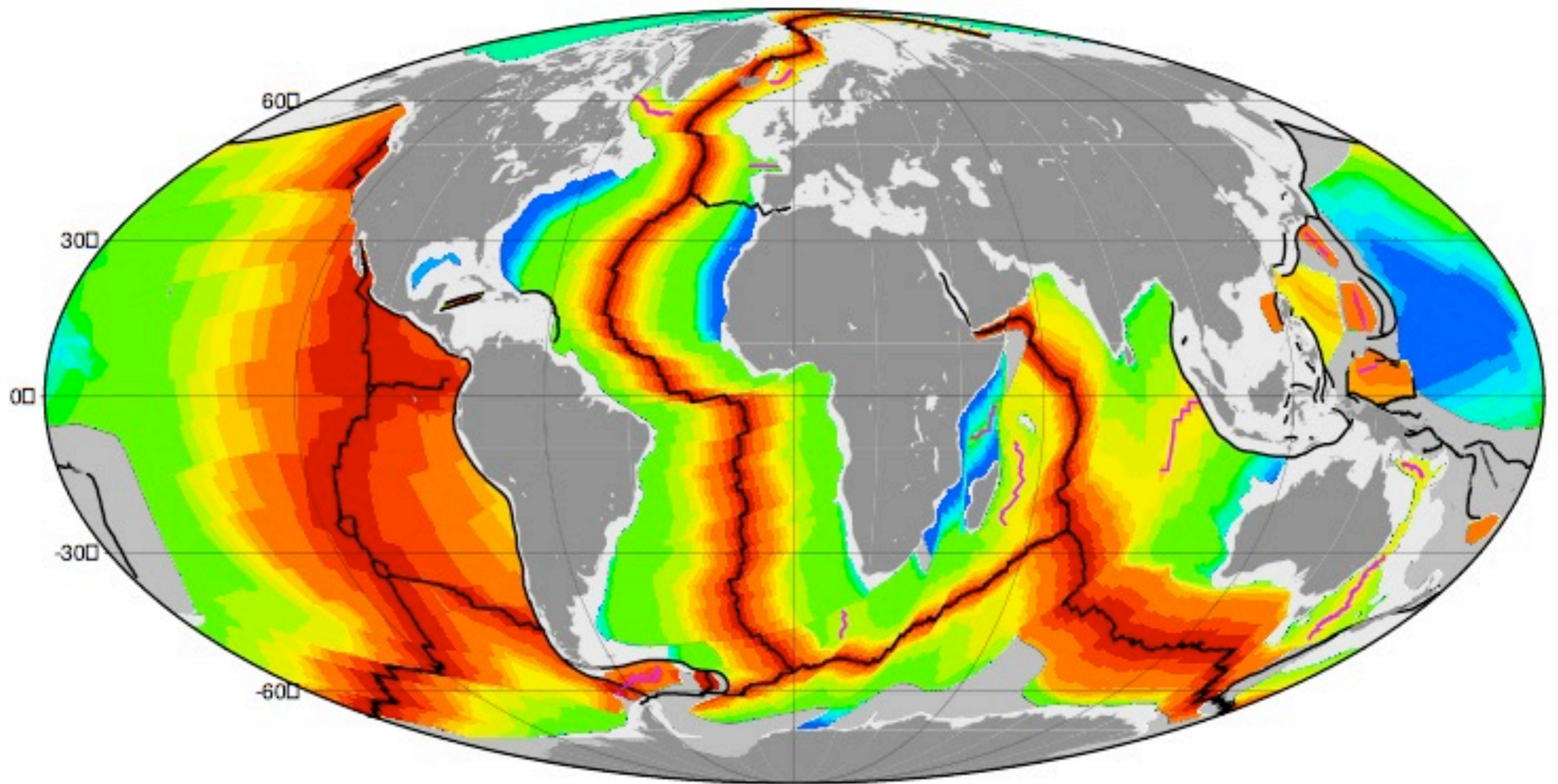

*Müller et al. 1997*





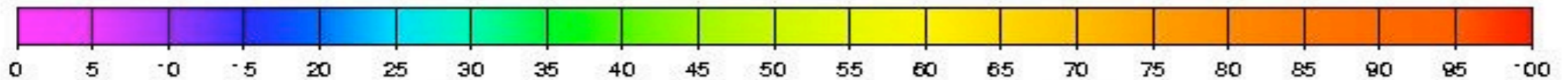
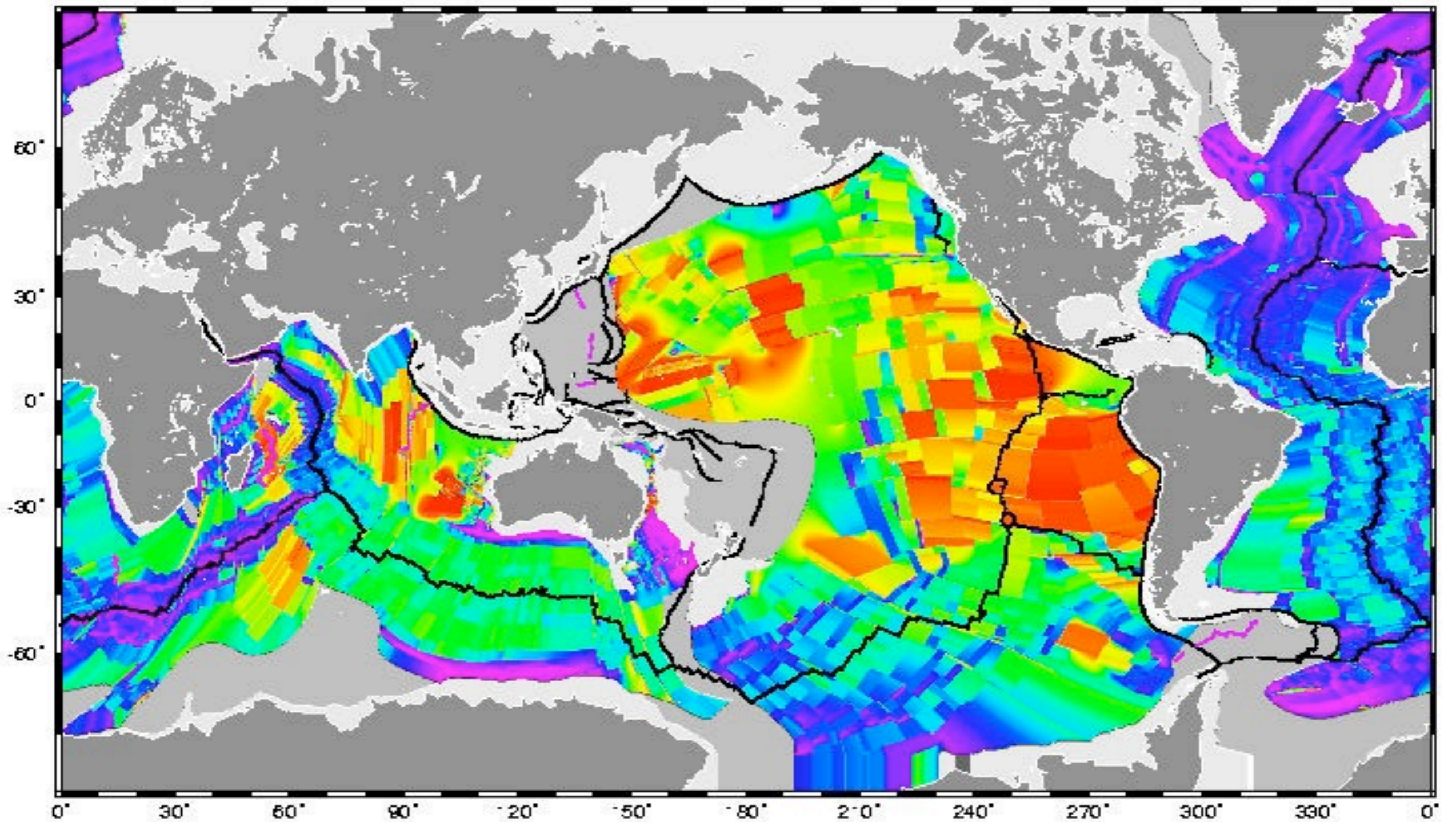

Spreading half-rate [mm/yr]

**demi-vitesse d'ouverture**



# Volcanisme de dorsale Pillow-lavas (laves en coussins)



Les campagnes de plongée  
montrent la réalité du  
volcanisme des dorsales, puis  
des déformations dans les fosses  
de subduction



# Le système GPS

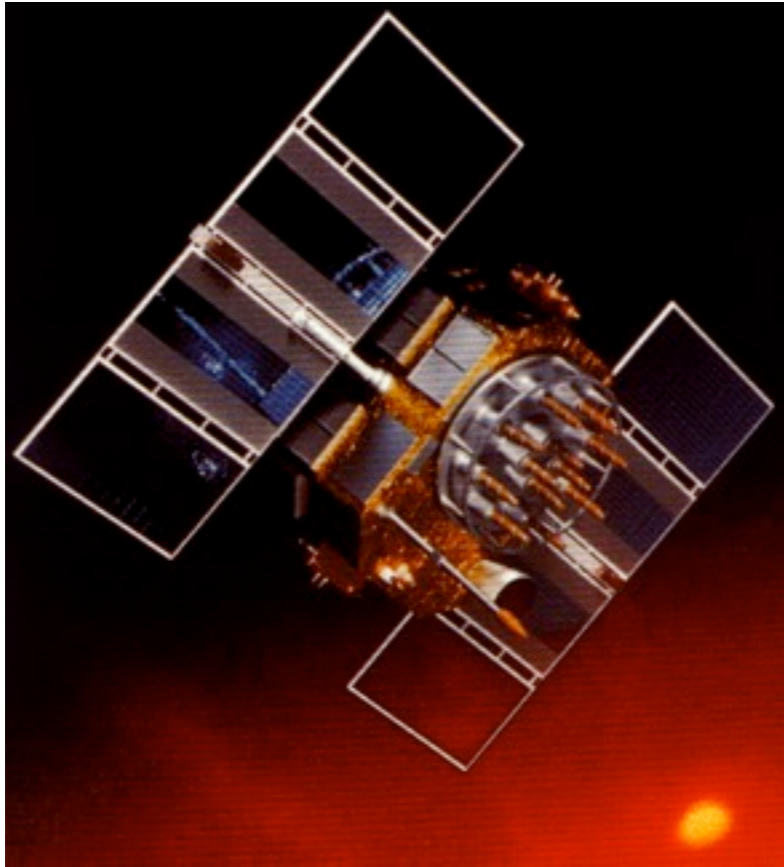

**Satellite**

**Antenne**

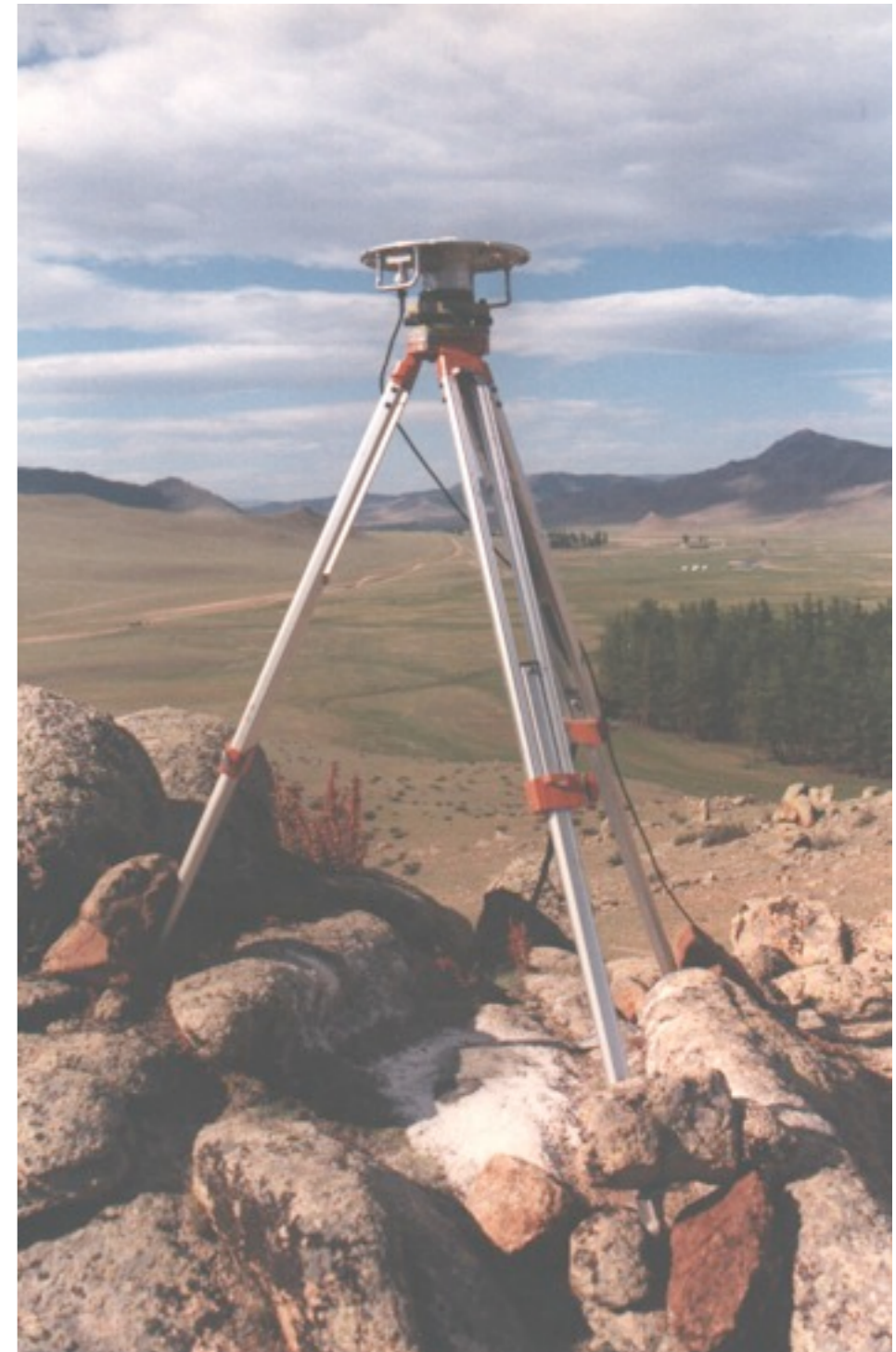

**Récepteur**



Beaucoup plus récemment les mesures des déformations et des déplacements de la croûte sont grâce aux méthodes géodésiques (GPS...)



# Sites de mesures géodésiques

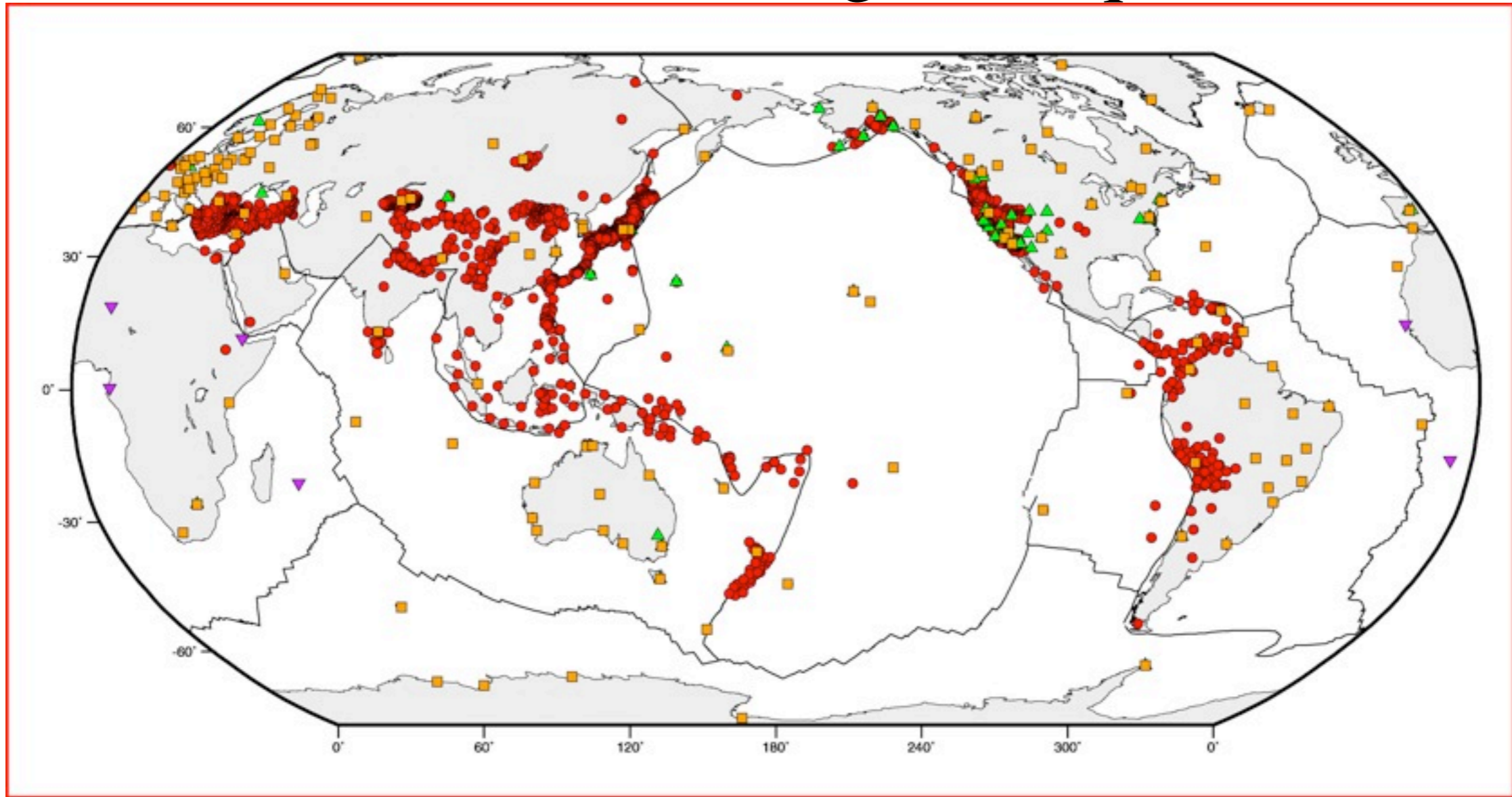

- Réseaux GPS régionaux (une cinquantaine, près de 3000 sites)
- Réseau GPS global (>150)
- ▲ Réseau VLBI global [*Ma & Ryan, 1998*] (70 sites)
- ▼ Réseau DORIS [*Crétaux et al., 1998*] (in *Kreemer, 2002*)



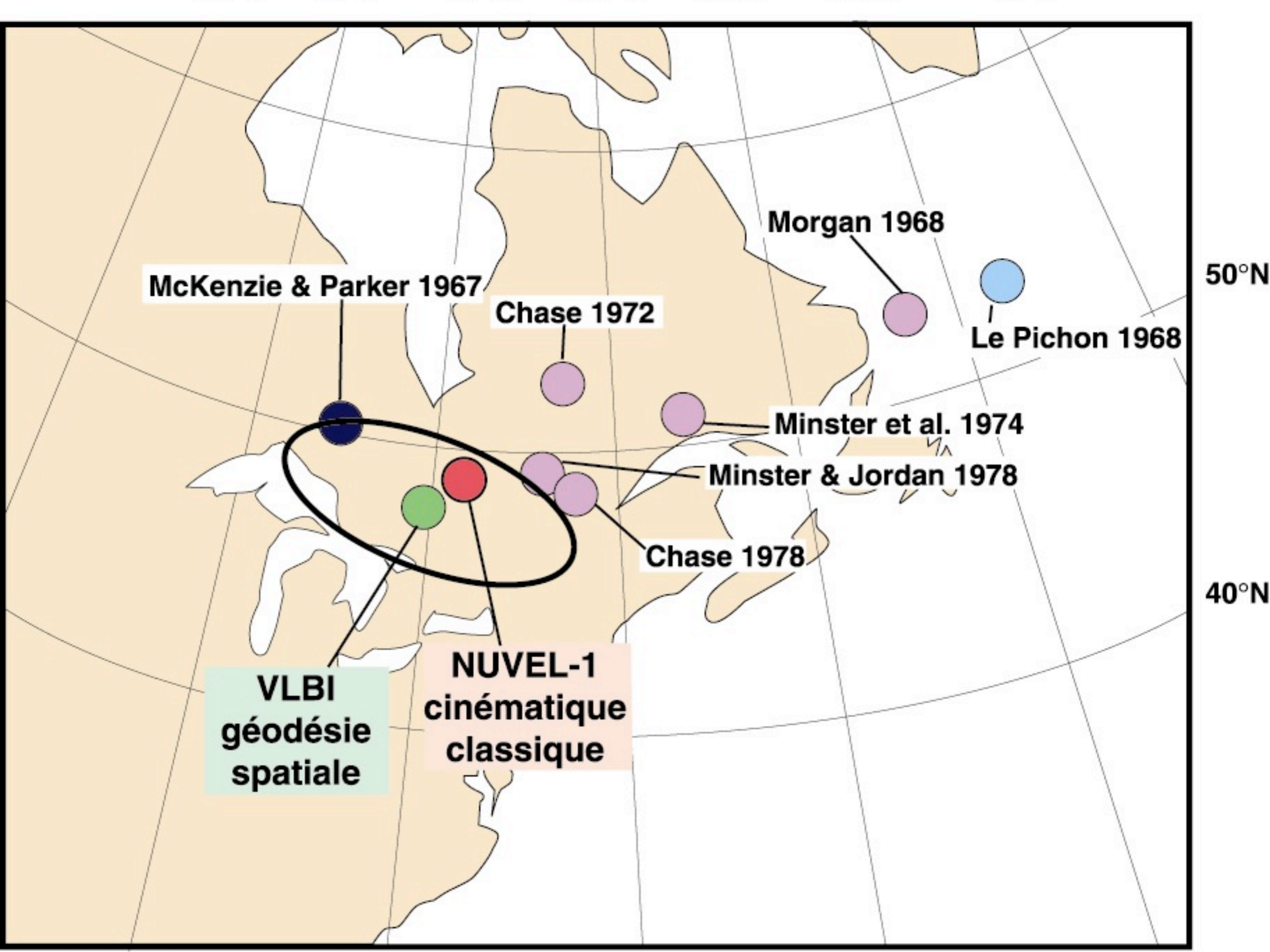

McKenzie & Parker 1967

Chase 1972

Morgan 1968

Le Pichon 1968

50°N

Minster et al. 1974

Minster & Jordan 1978

Chase 1978

40°N

VLBI  
géodésie  
spatiale

NUVEL-1  
cinématique  
classique

On observe une coincidence presque parfaite entre les vitesses prédites par la cinématique des plaques «classique» et les vitesses mesurées directement par géodésie.

## Vitesses mesurées vs. prédites

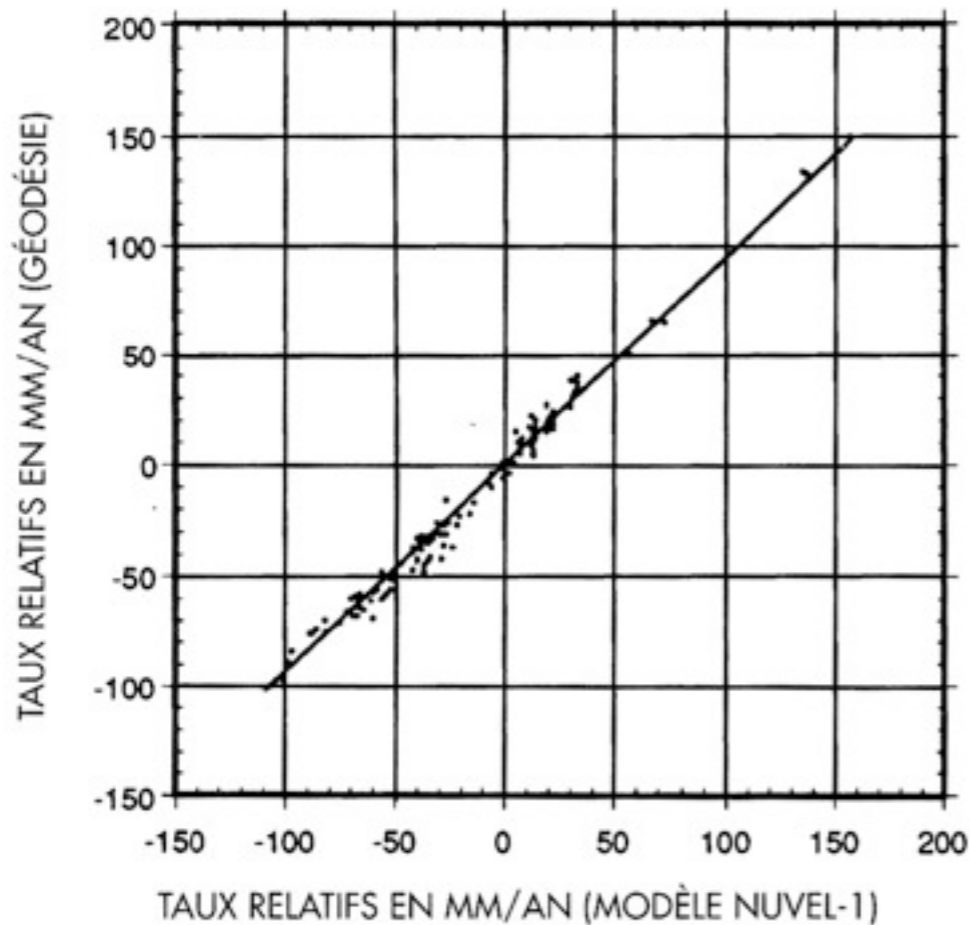

SLR+VLBI  
(*Robbins et al.*, 1993)

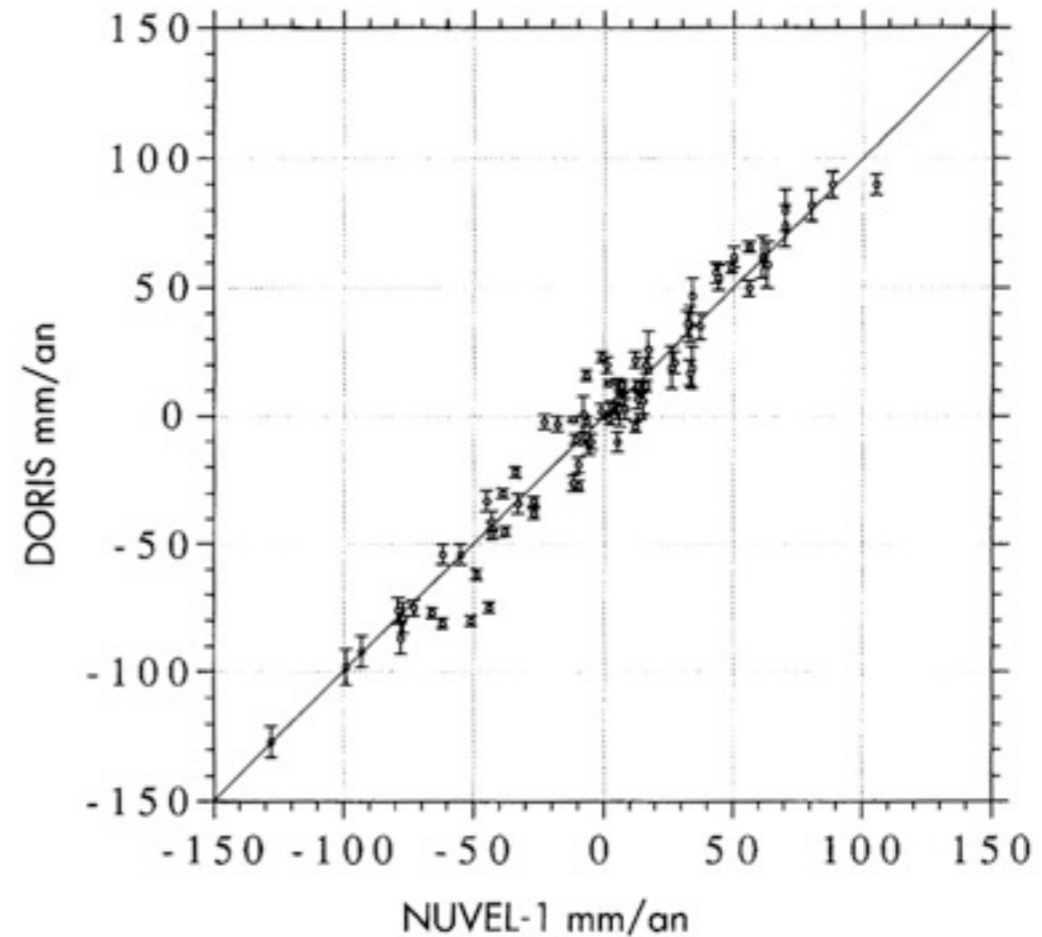

DORIS  
(*Soudarin*, 1994)

Vitesses mesurées par géodésie comparées aux vitesses prédites par le modèle « géologique » NUVEL-1



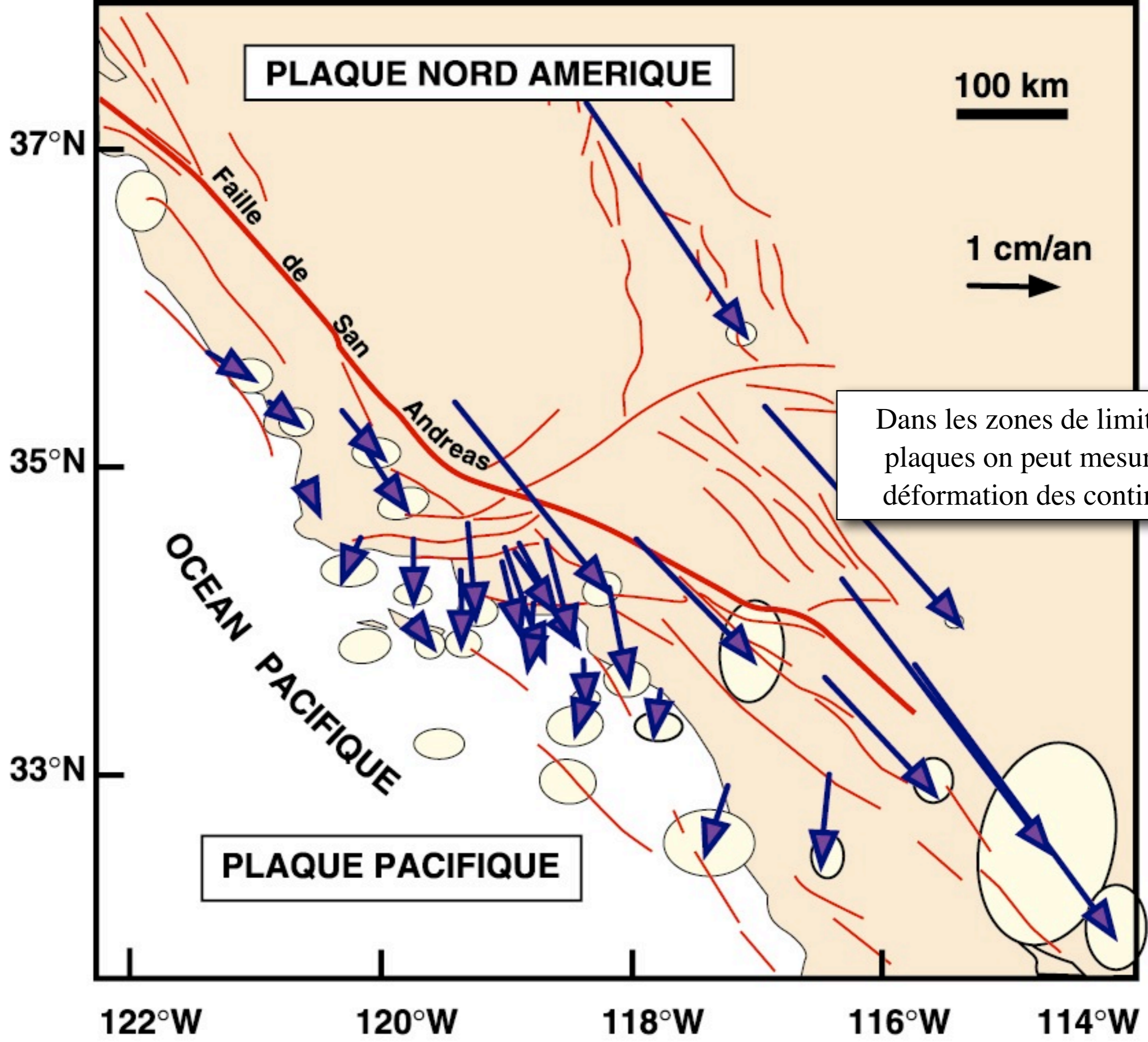

PLAQUE NORD AMERIQUE

100 km

37°N

Faille de San Andreas

1 cm/an

35°N

Dans les zones de limites de plaques on peut mesurer la déformation des continents

OCEAN PACIFIQUE

33°N

PLAQUE PACIFIQUE

122°W

120°W

118°W

116°W

114°W



Dans les zones de limites de plaques on peut mesurer la déformation des continents

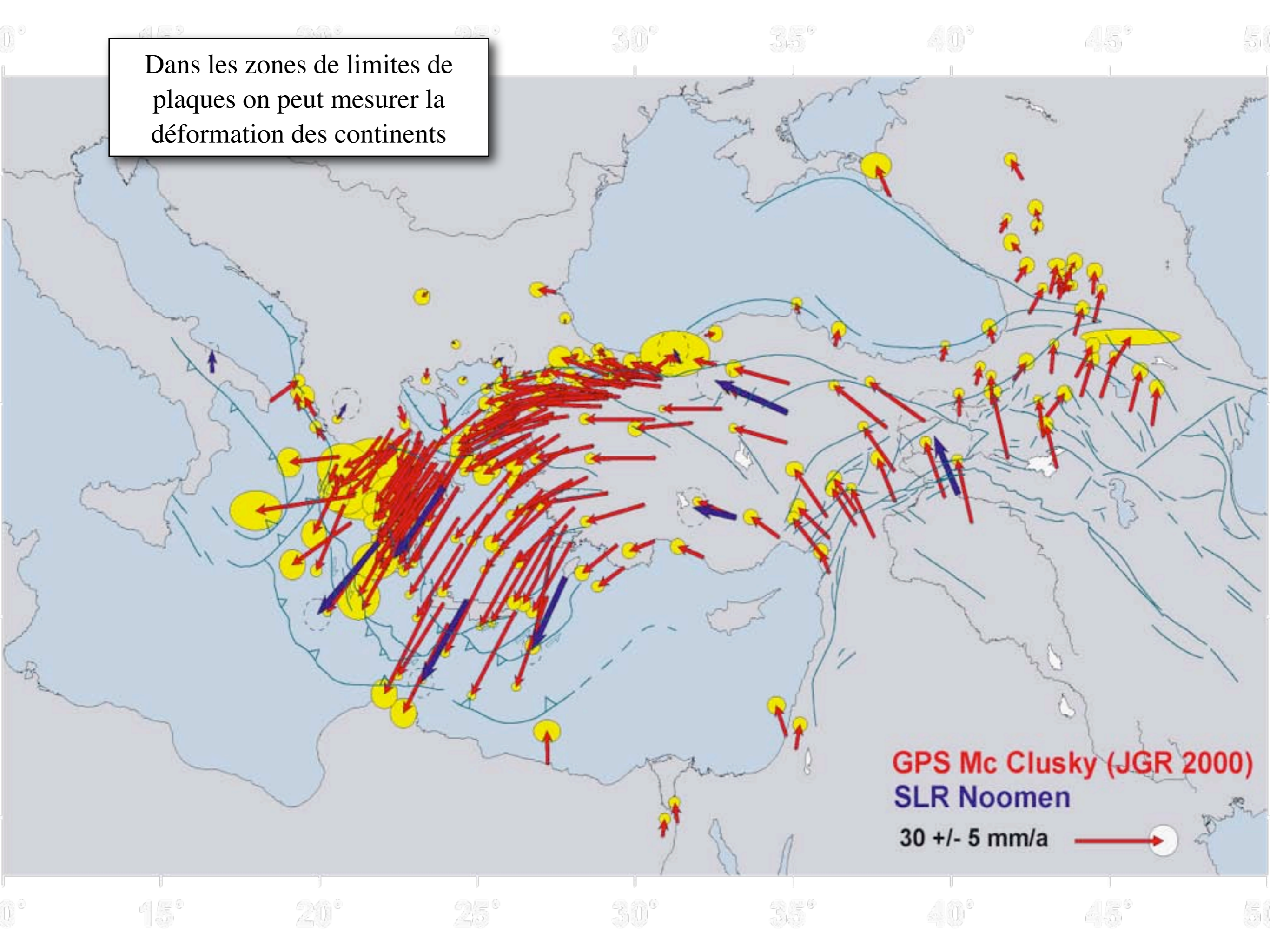

GPS Mc Clusky (JGR 2000)  
SLR Noomen  
30 +/- 5 mm/a



# Frontières de plaques

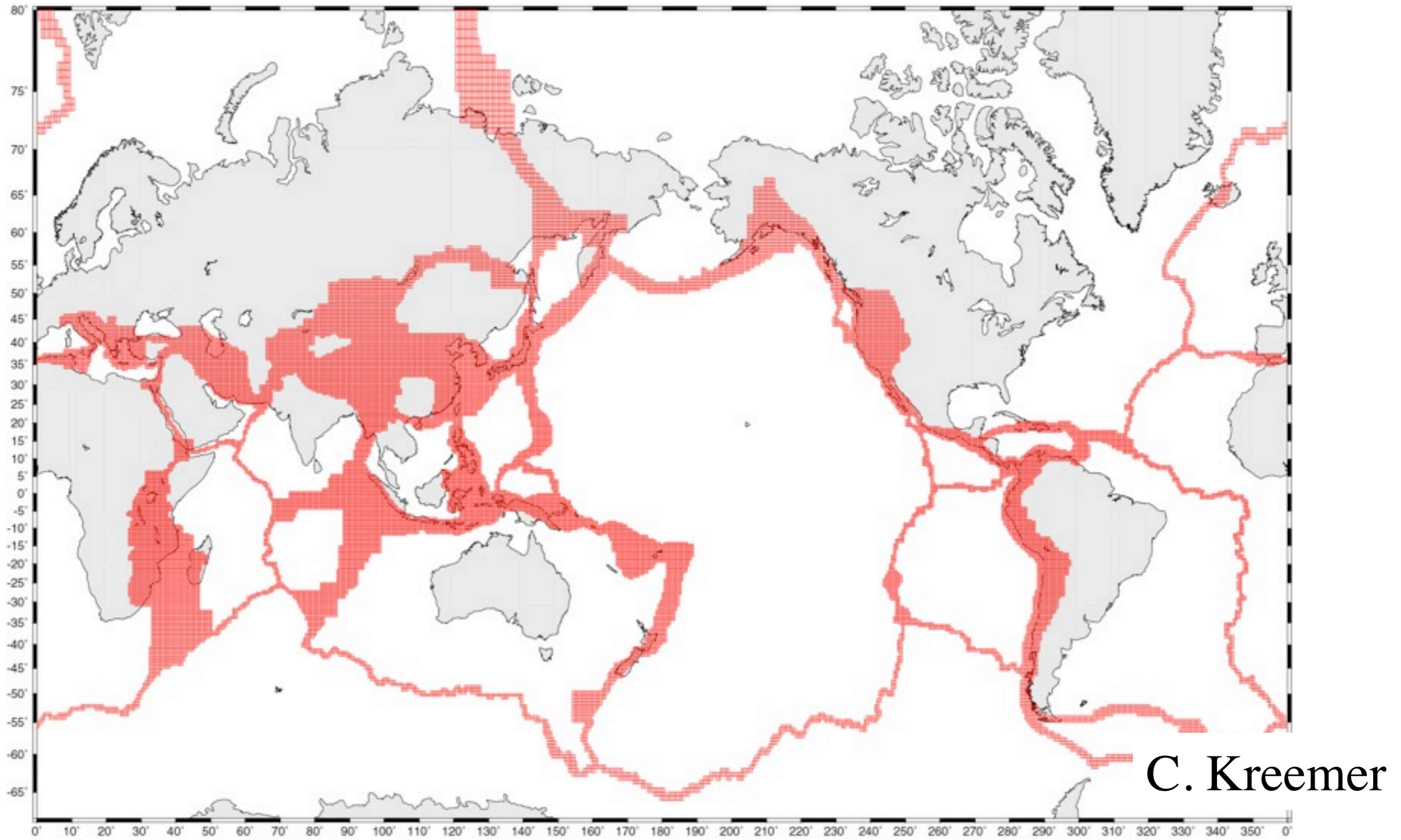





# Prise en compte de la déformation interne des frontières de plaques (*Kreemer et al.*, 2002)

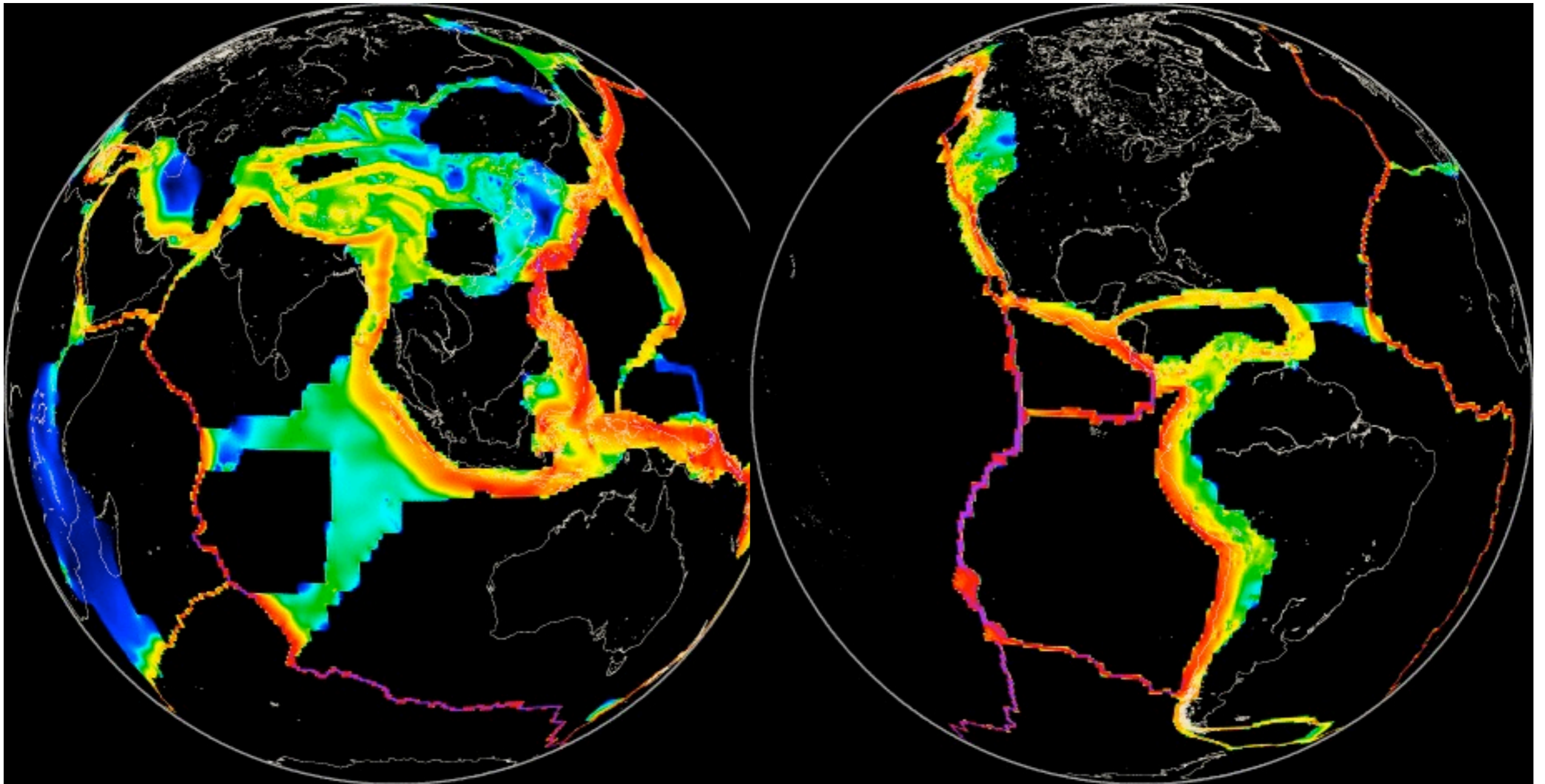

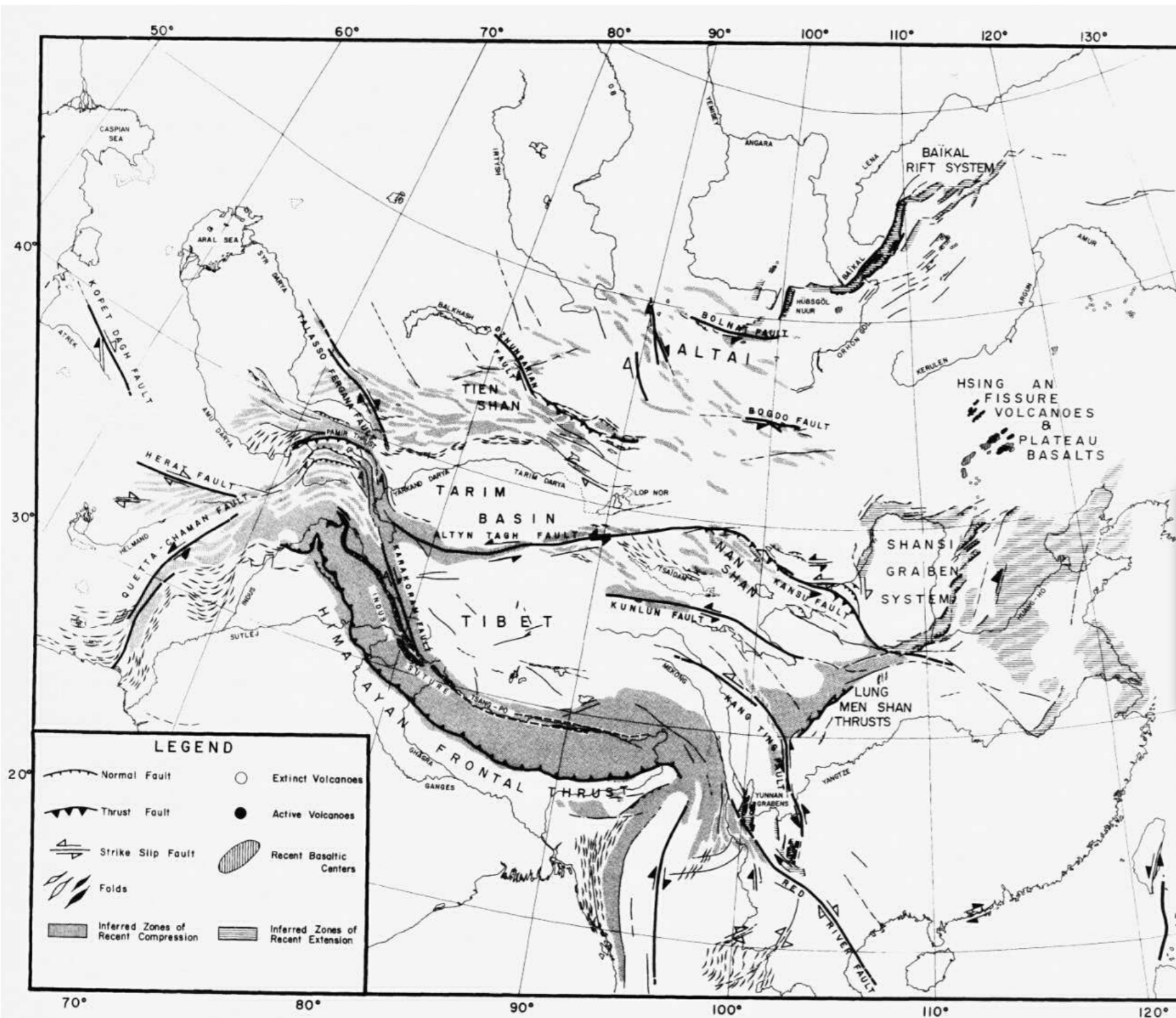

Le plus bel exemple est sans conteste la déformation de la lithosphère asiatique sous la poussée de l'Inde

Tapponnier et Molnar, 1977

Map of eastern Asia showing large-scale structure inferred from mapped geology, the interpretation of Landsat imagery, published studies of surface faulting associated with great earthquakes, and fault-plane solutions of more moderate earthquakes. Note the prevalence of large strike-slip faults, right-lateral on faults trending NW to NNW-SSE and left-lateral on faults trending E-W. Tapponnier, P. and P. Molnar, Active faulting and tectonics of China, *J. Geophys. Res.*, 82, 2905–2930, 1977.



cinématique absolue

*Les points chauds, passage de la  
cinématique à la dynamique*

# Le modèle NUVEL-1 (*DeMets et al., 1990*)

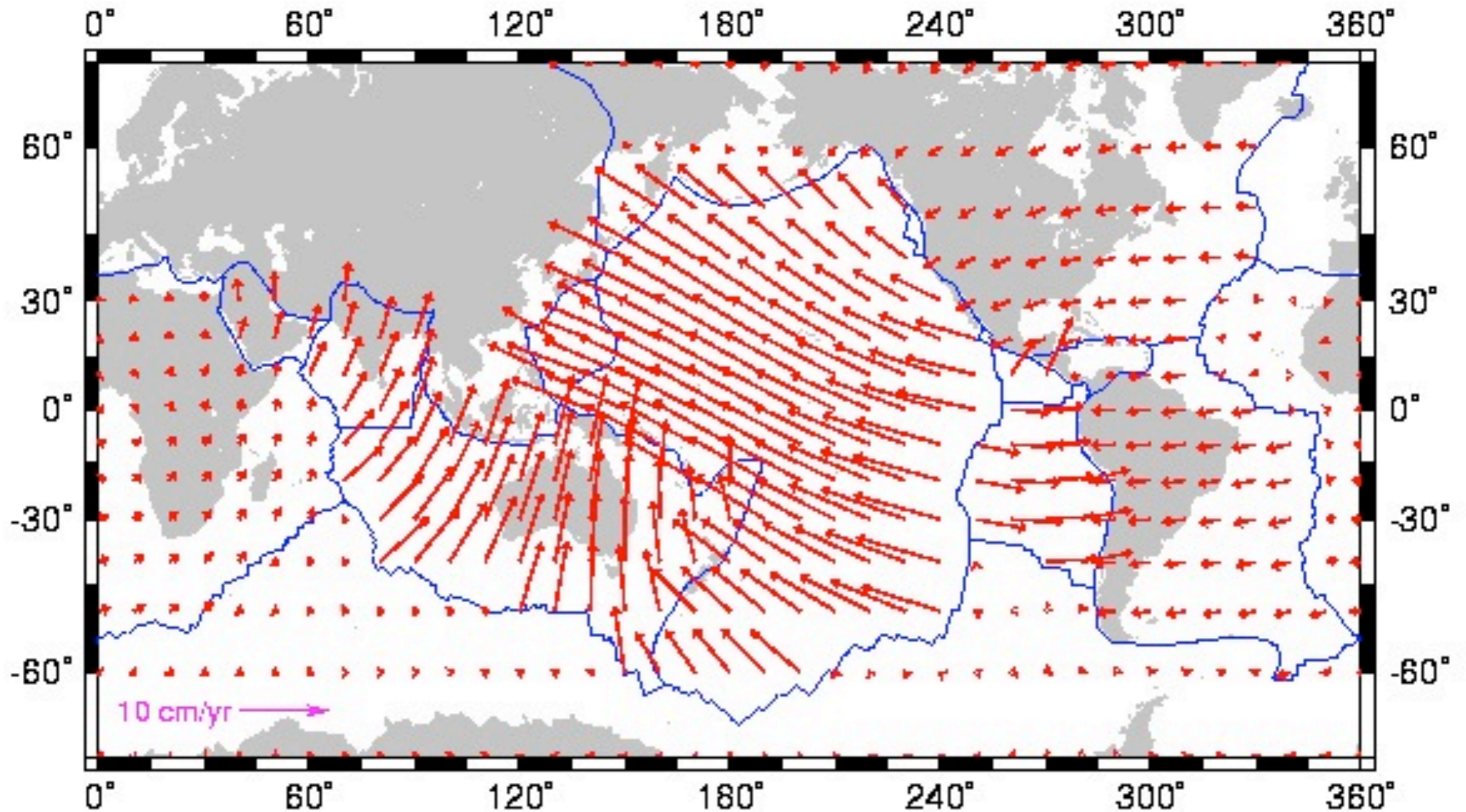

NB: tous les mouvements sont par rapport à l'Eurasie fixe



# Le modèle NUVEL-1 (*DeMets et al.*, 1990)

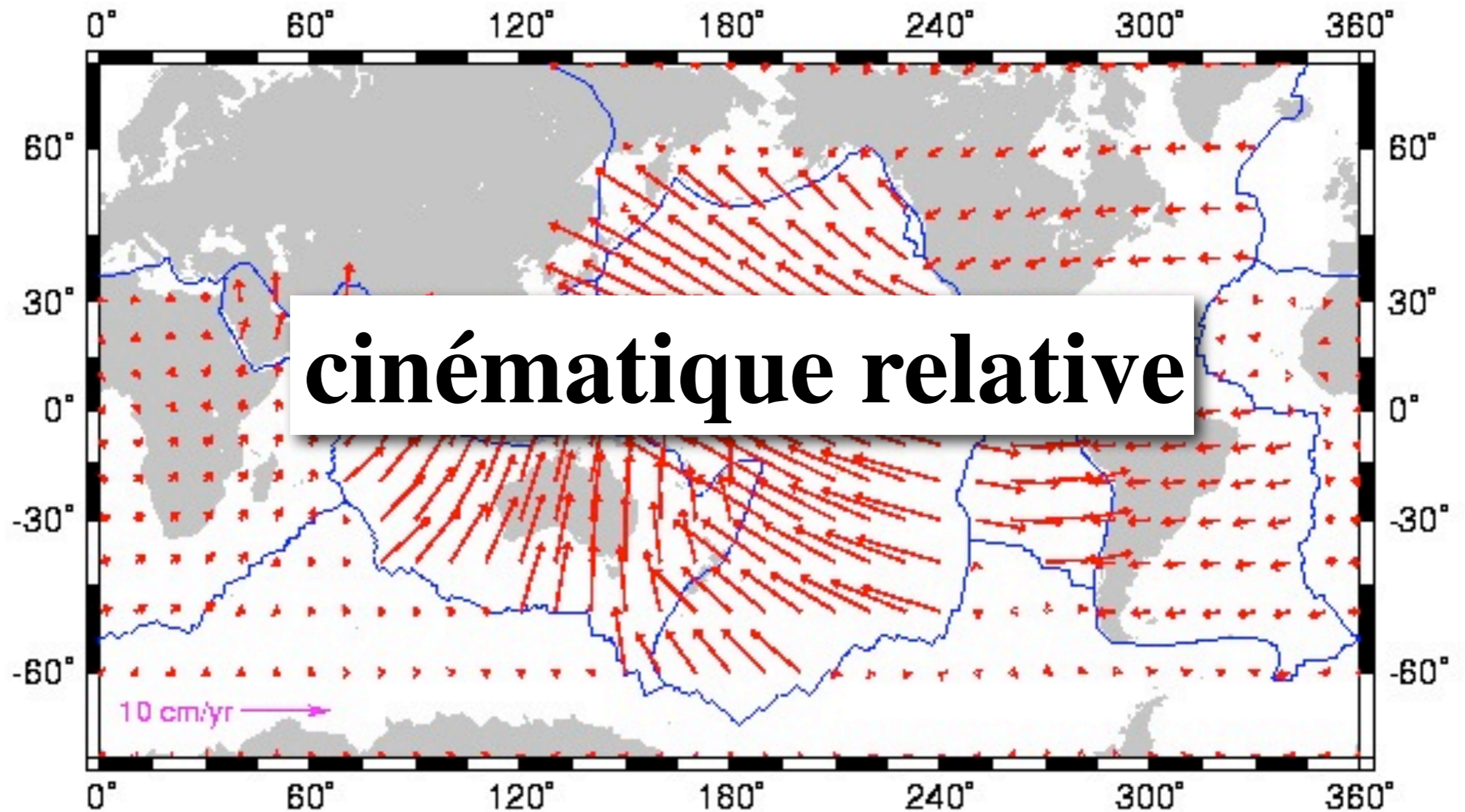

NB: tous les mouvements sont par rapport à l'Eurasie fixe

# Le modèle NUVEL-1 (*DeMets et al.*, 1990)

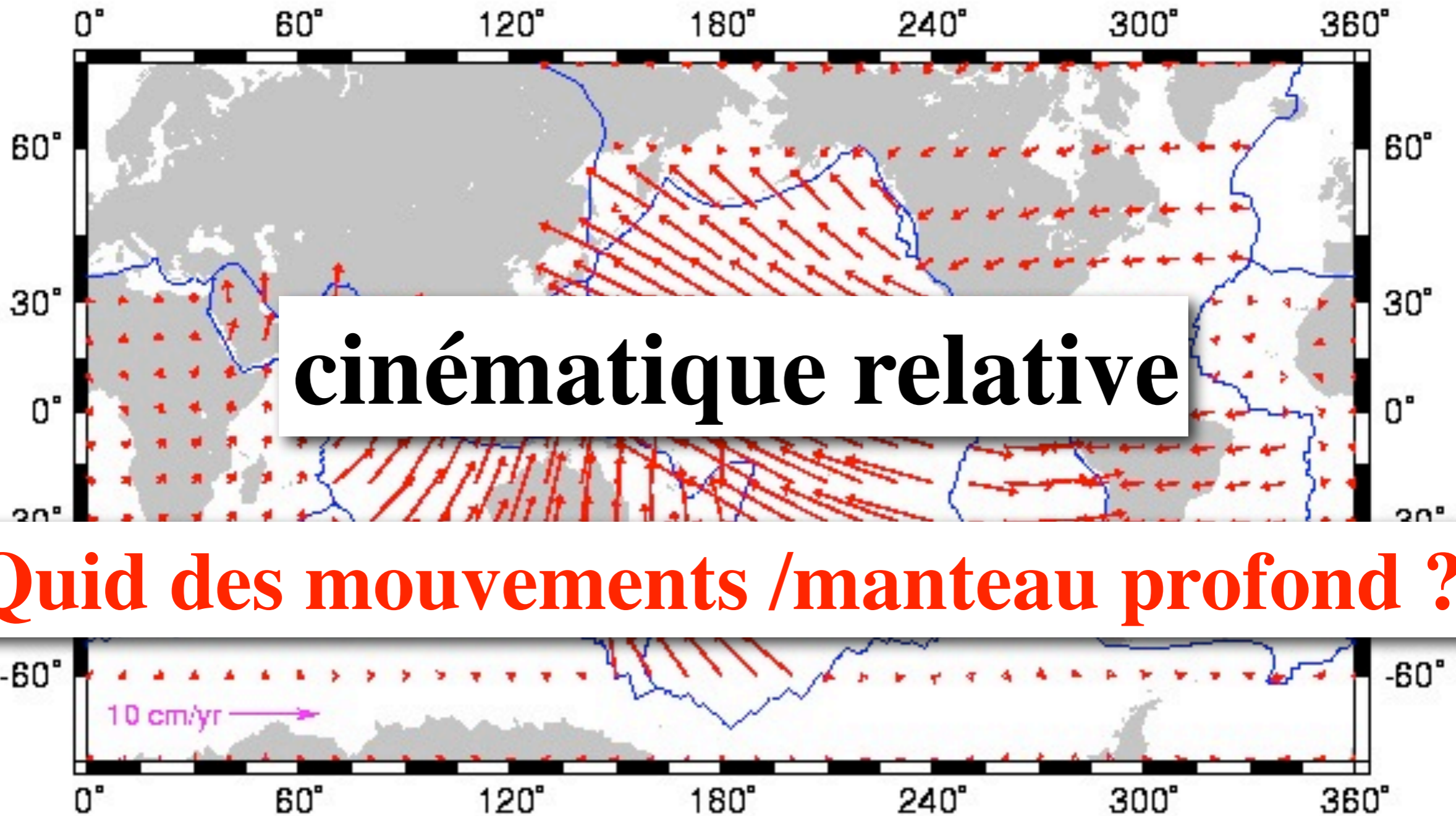

**Quid des mouvements /manteau profond ?**

NB: tous les mouvements sont par rapport à l'Eurasie fixe



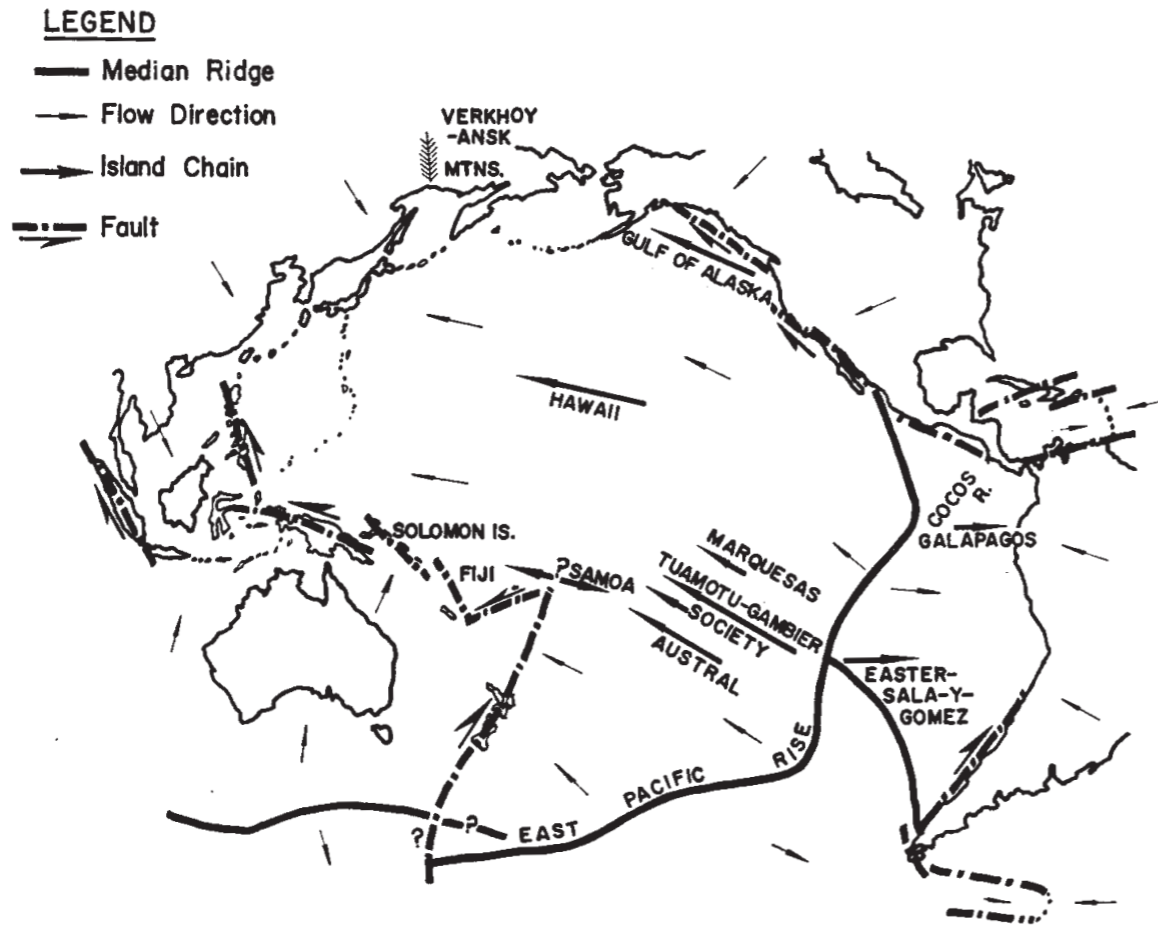

FIG. 1. Sketch of Pacific Ocean. Heavy arrows show nine linear chains of islands and seamounts which increase in age in direction of arrow. Single-headed arrows show direction of motion, where known, along large transcurrent faults. Small arrows show postulated direction of flow away from median ridges.

Wilson, 1963

Les premières idées sur les relations entre convection, tectonique des plaques et ce qu'on appelle aujourd'hui les points chauds ont été proposées très tôt

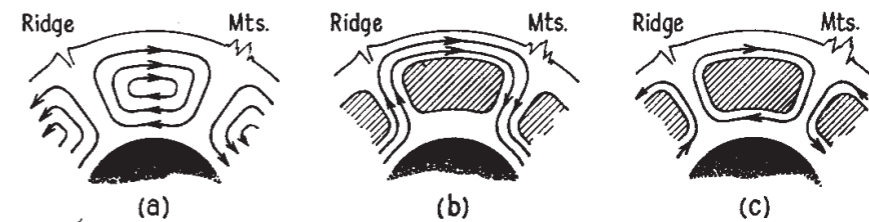

FIG. 2. Three possible modes of convection in the Earth's mantle.

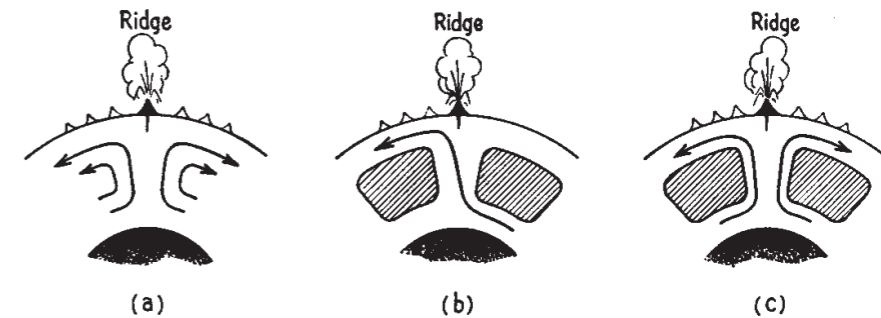

FIG. 3. Some possible patterns of convection, showing that, if active volcanoes form over rising vertical currents, chains of extinct volcanoes might be formed by the horizontal flow or the currents. The shaded areas represent stable cores of cells.



FIG. 4. Diagram to illustrate that in general if lava is generated at some other point of a convection system than over a rising current, then only one volcano will be generated.

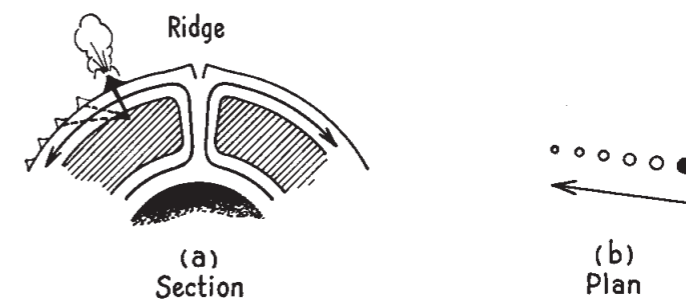

FIG. 5. Diagram to illustrate that if lava is generated in the stable core of a convection cell, and the surface is carried by the jet stream, then one source can give rise to a chain of extinct volcanoes even if the source is not over a rising current. This is proposed as a possible origin of the Hawaiian chain of islands.

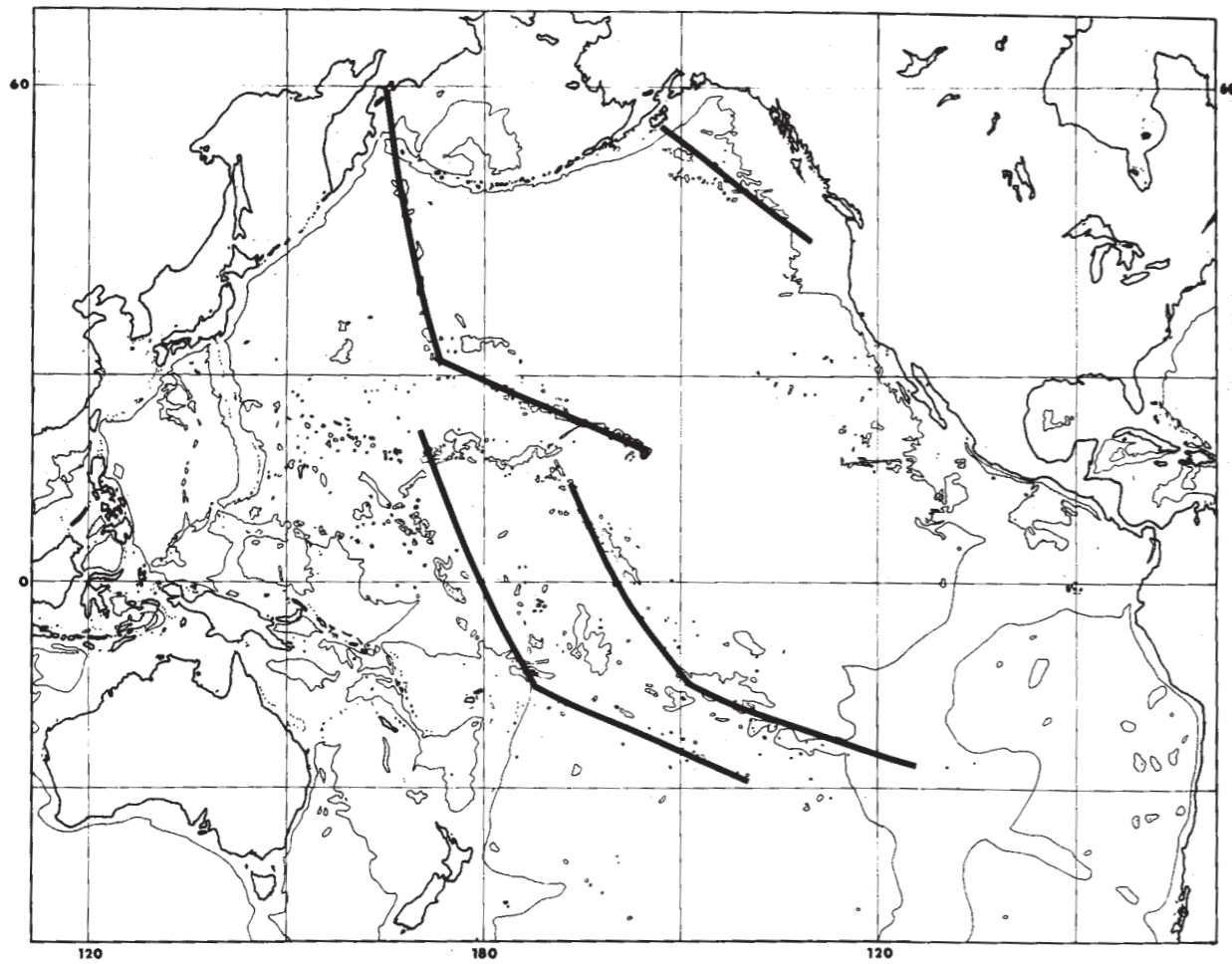

FIG. 1—Hot-spot trajectories constructed by rotating Pacific plate over four fixed hot-spots.

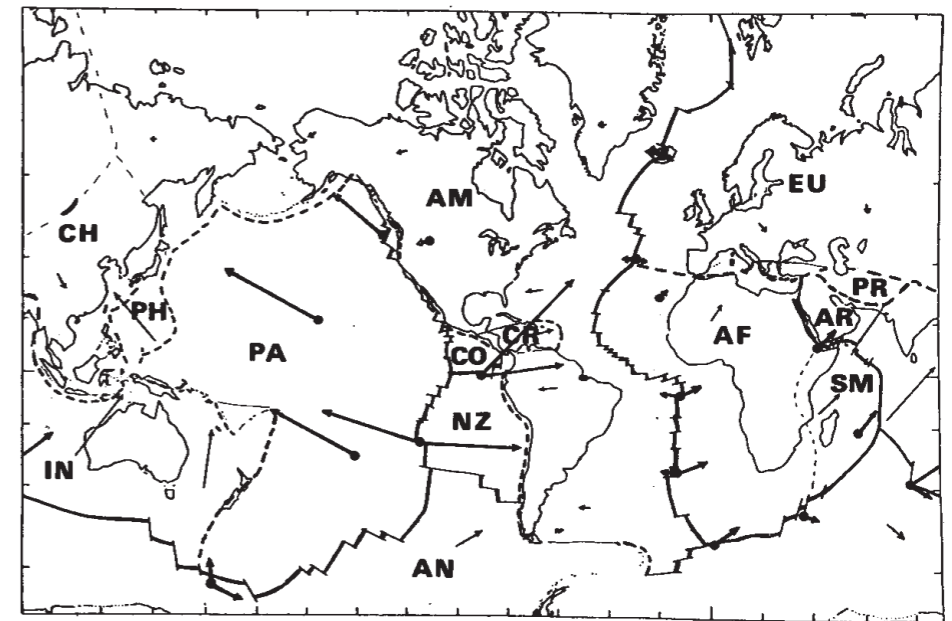

FIG. 3—Present motions of plates over hot-spots. Relative plate motions were determined from fault strikes and spreading rates on rise boundaries; with an appropriate constant rotation added, absolute motions of each plate over mantle were determined. Lengths of arrows are proportional to plate speed.

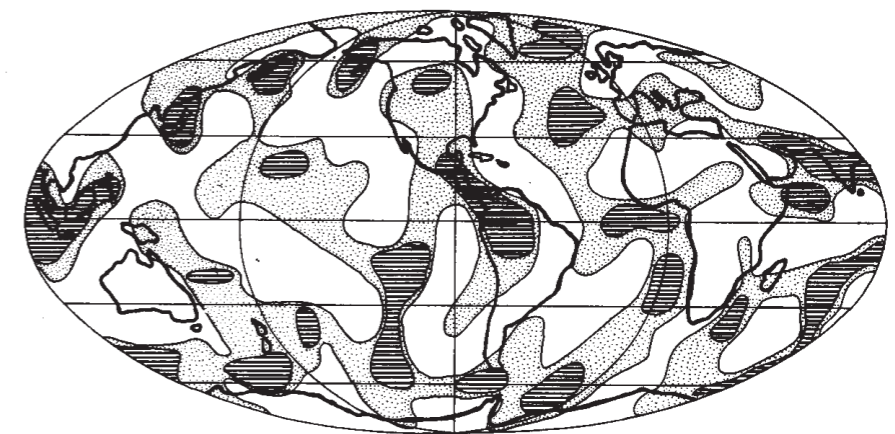

FIG. 4—Isostatic gravity map of earth constructed from spherical harmonic coefficients of degree 6 through 16. Shaded areas are regions of positive anomalies; heavier shaded areas are regions where anomalies are greater than +10 mgal. Note correlations of gravity highs with Iceland, Hawaii, and most other hot-spots (adapted from Kaula, 1970).

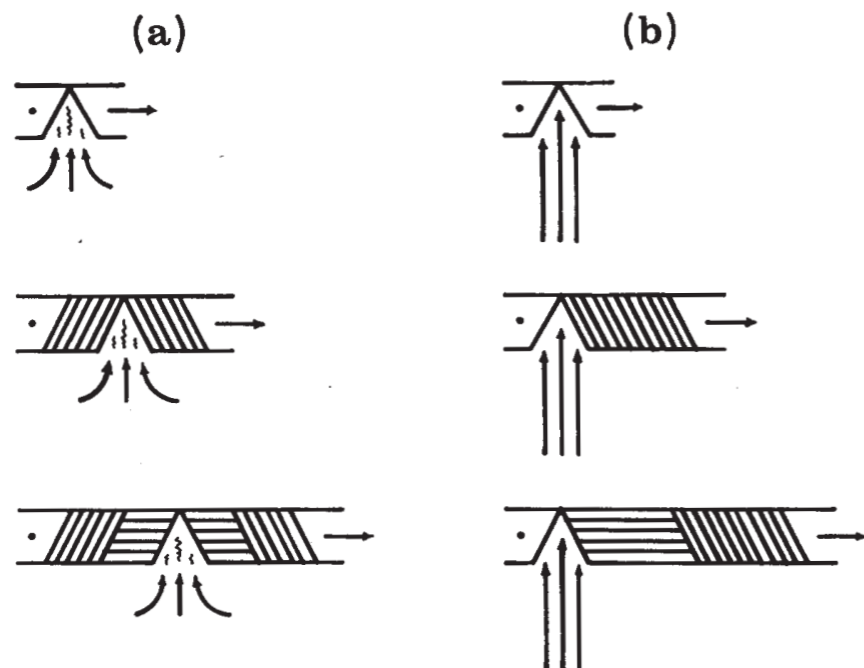
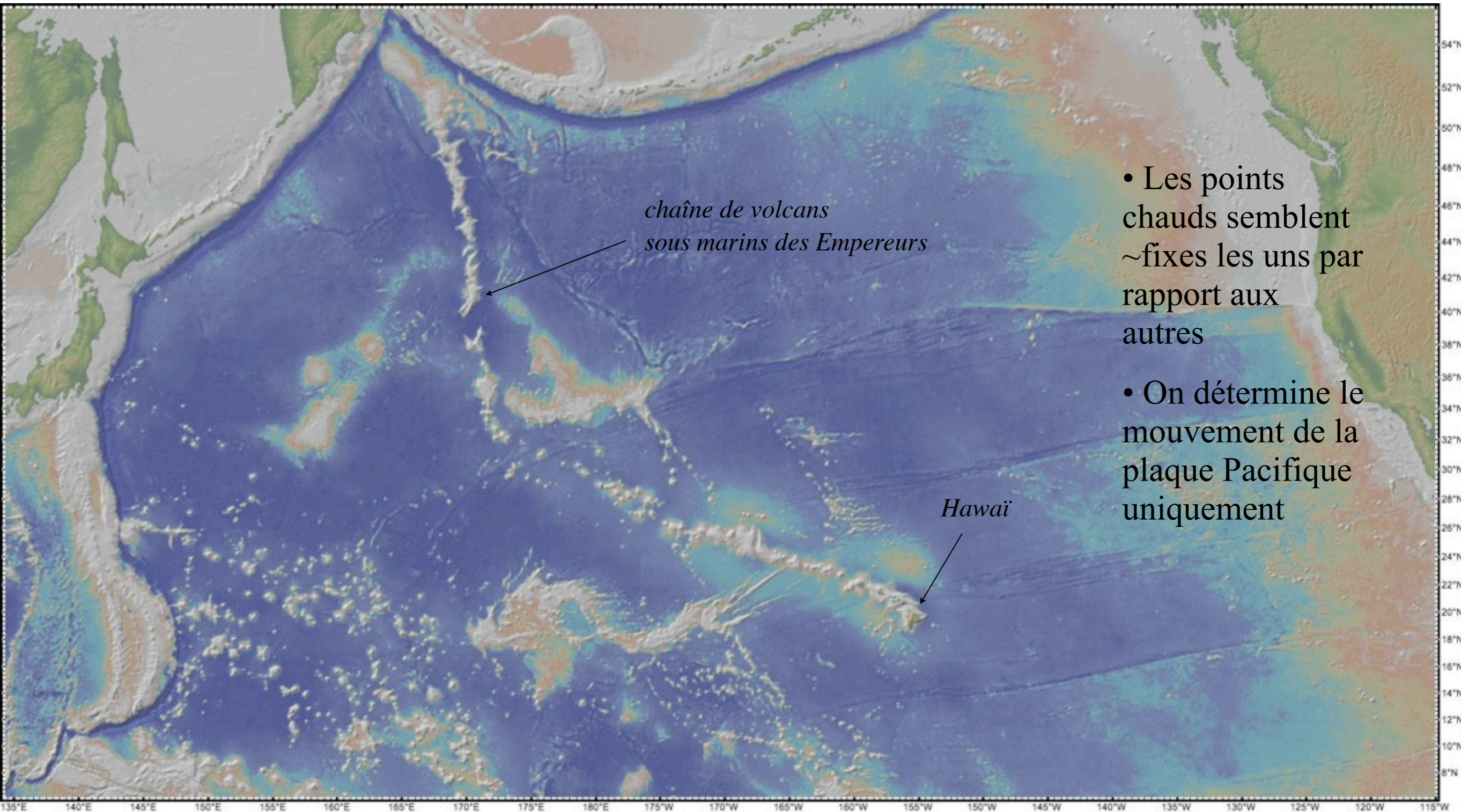

FIG. 5—In these symmetrical and asymmetric models of sea-floor spreading, left lithospheric plate is constrained to be fixed and right plate to move away at constant velocity. (a) If asthenosphere near rise fills gap made as plates move apart, symmetrical sea-floor spreading results. (b) If location of rising current is influenced strongly by conditions near bottom of asthenosphere, one-sided sea-floor spreading results.

## Les points chauds et la cinématique absolue



# Les points chauds et la cinématique absolue





# Les points chauds et la cinématique absolue

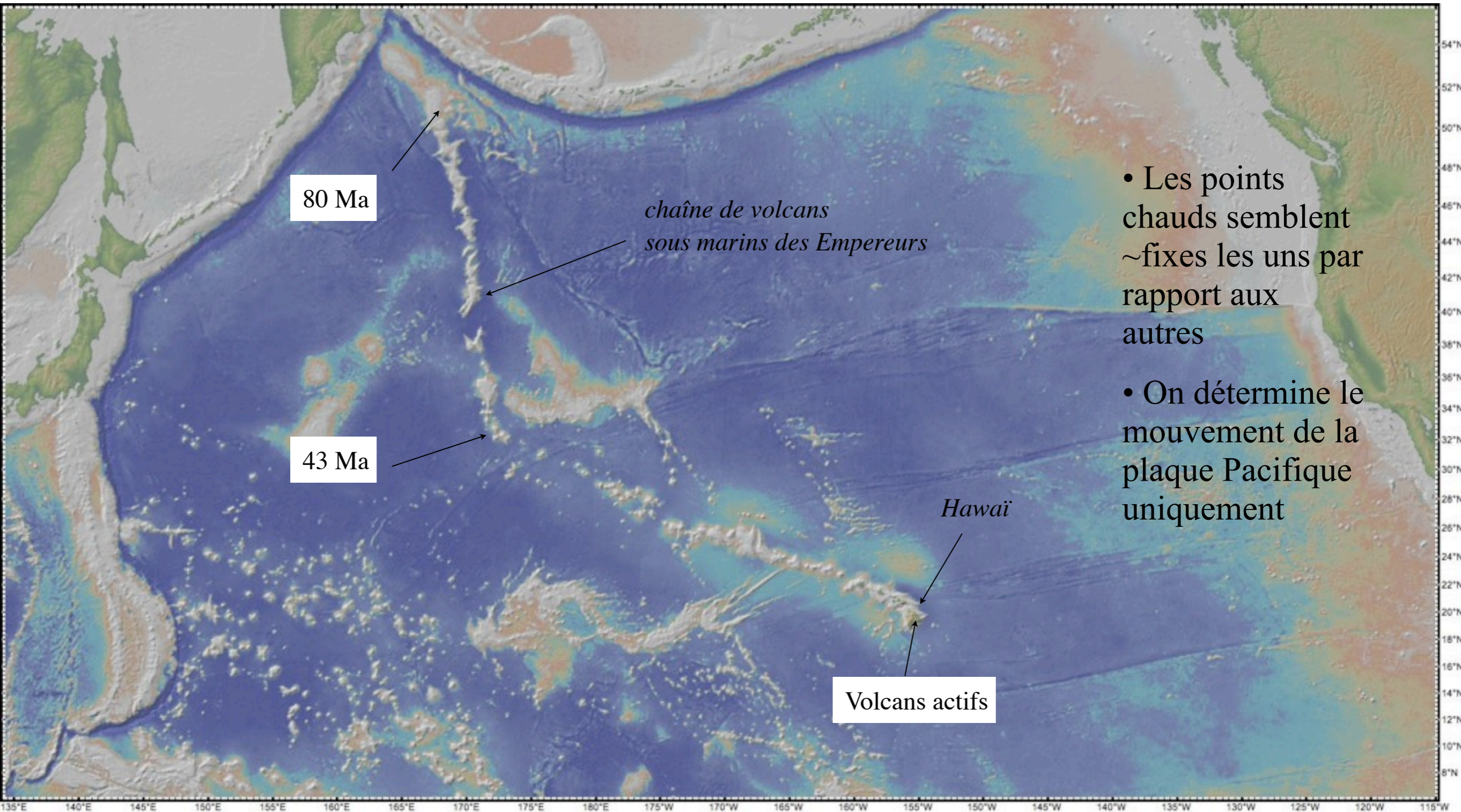

- Les points chauds semblent ~fixes les uns par rapport aux autres

- On détermine le mouvement de la plaque Pacifique uniquement



# Les points chauds et la cinématique absolue

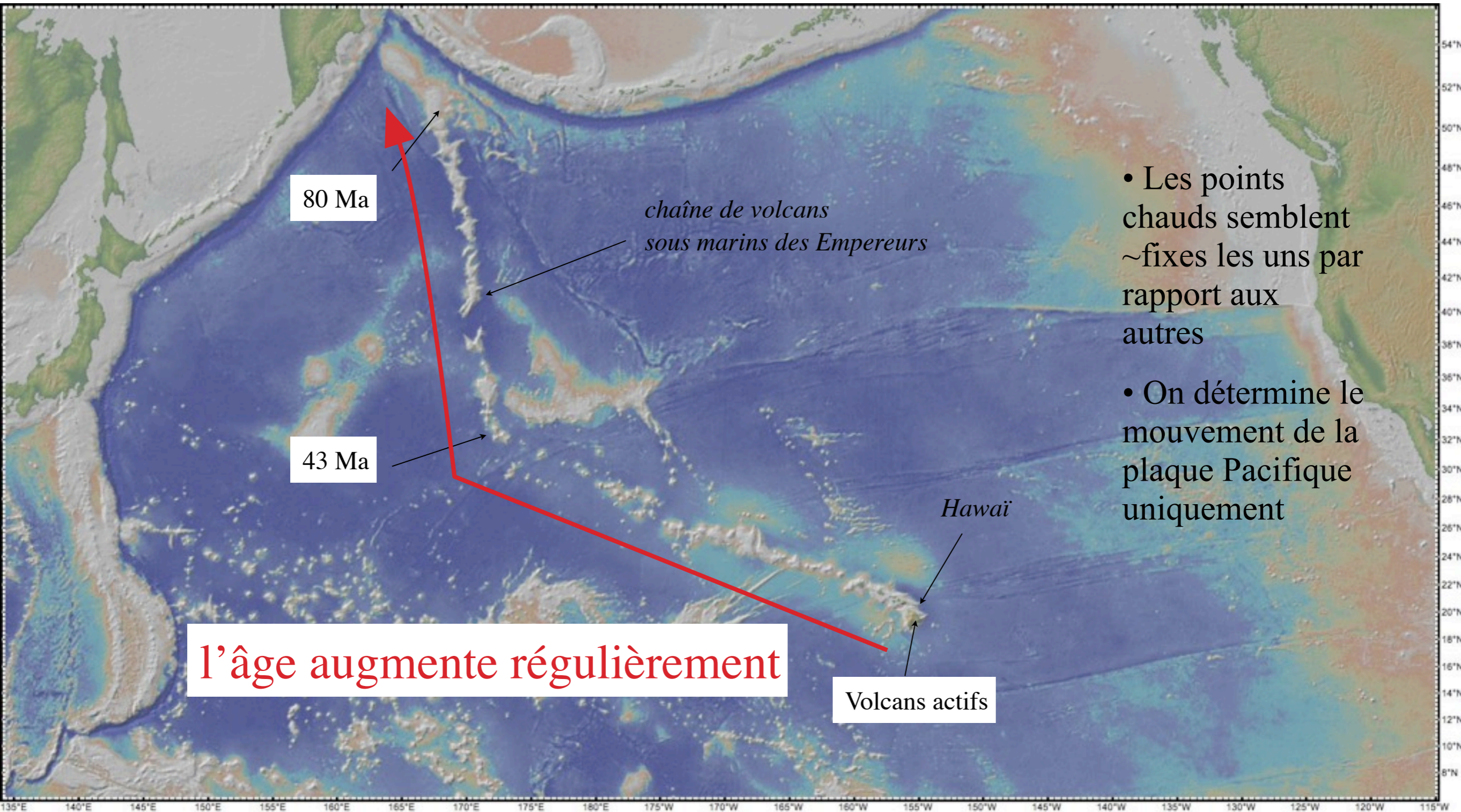



# Les points chauds et la cinématique absolue

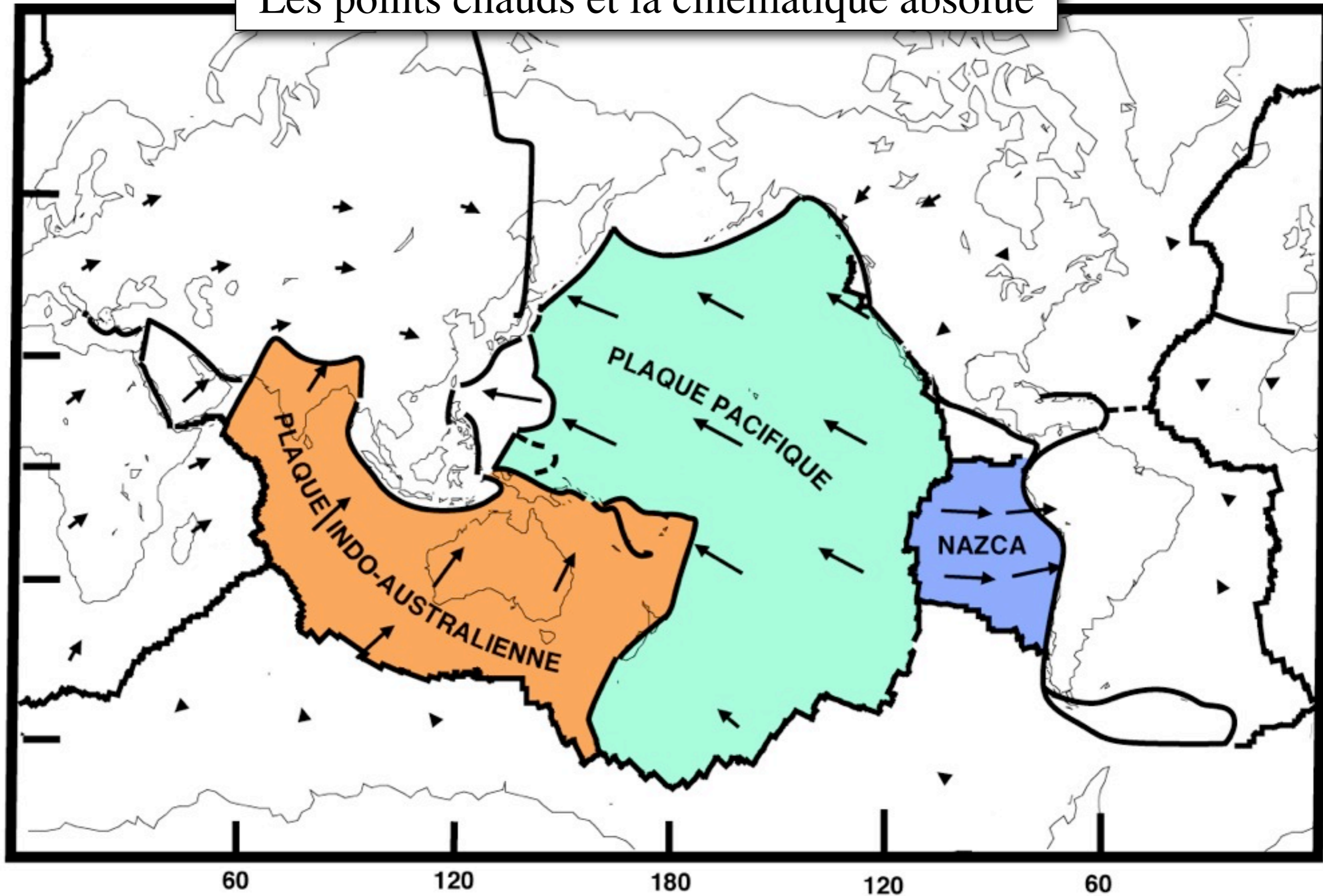



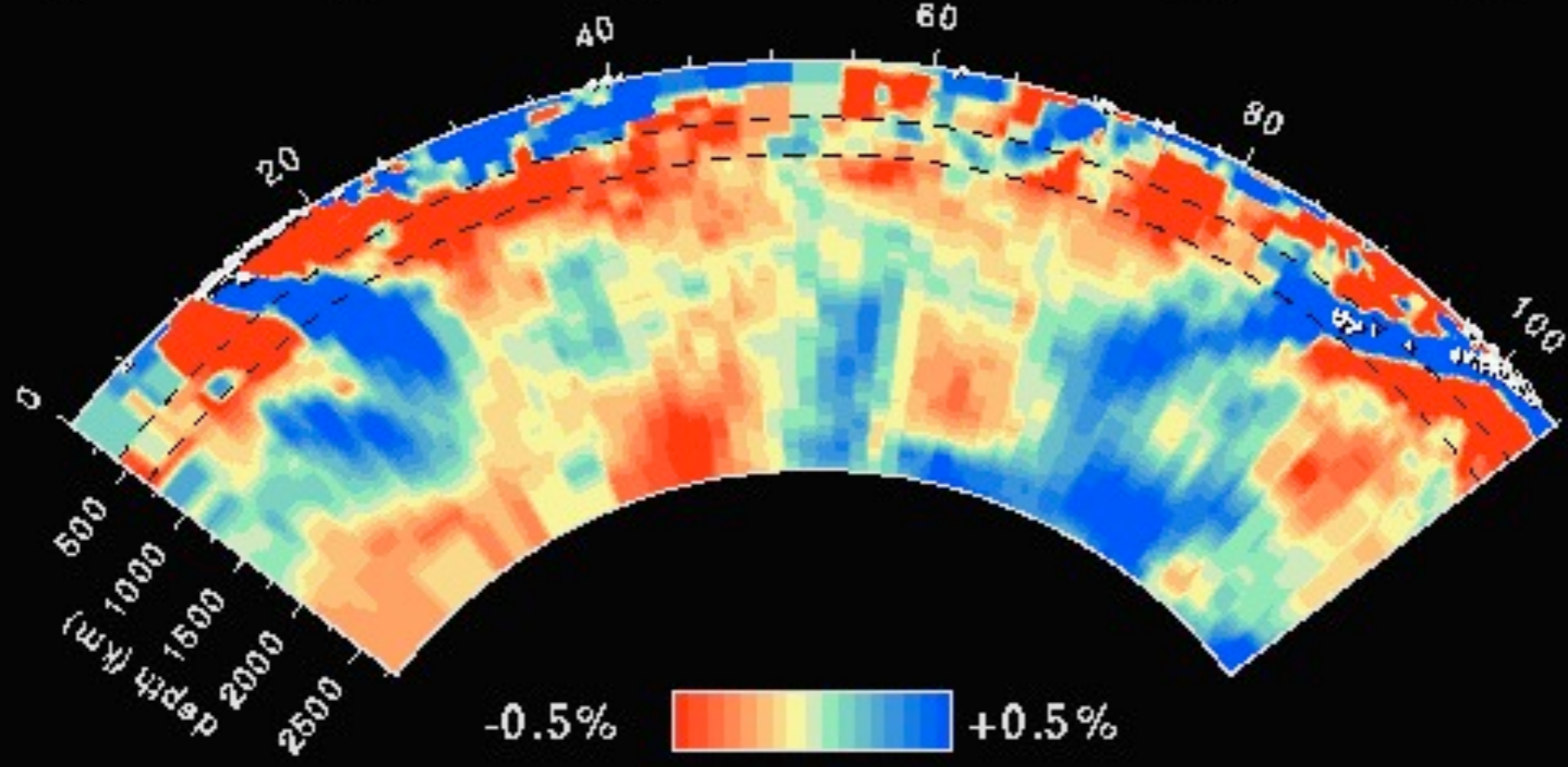
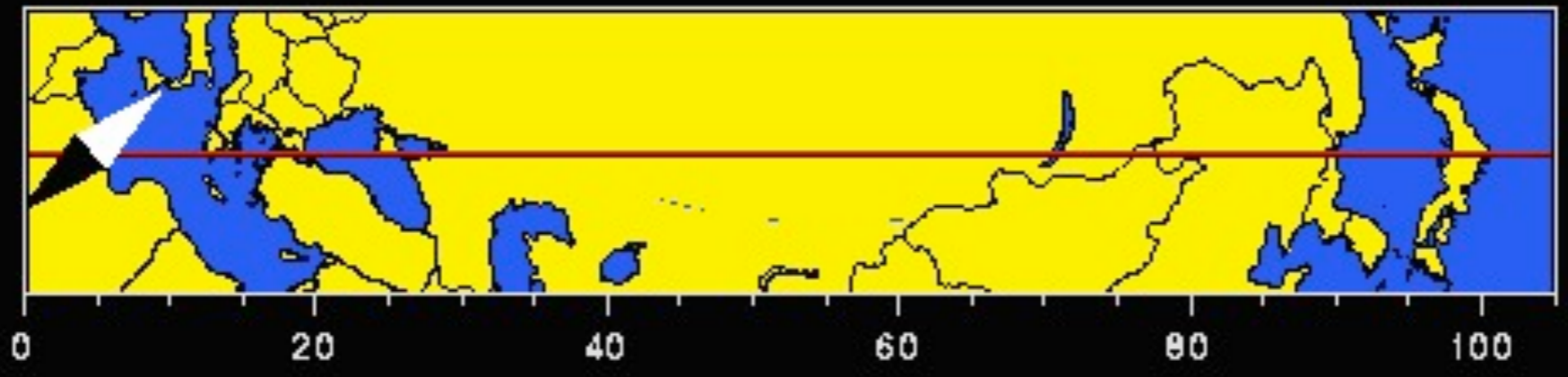





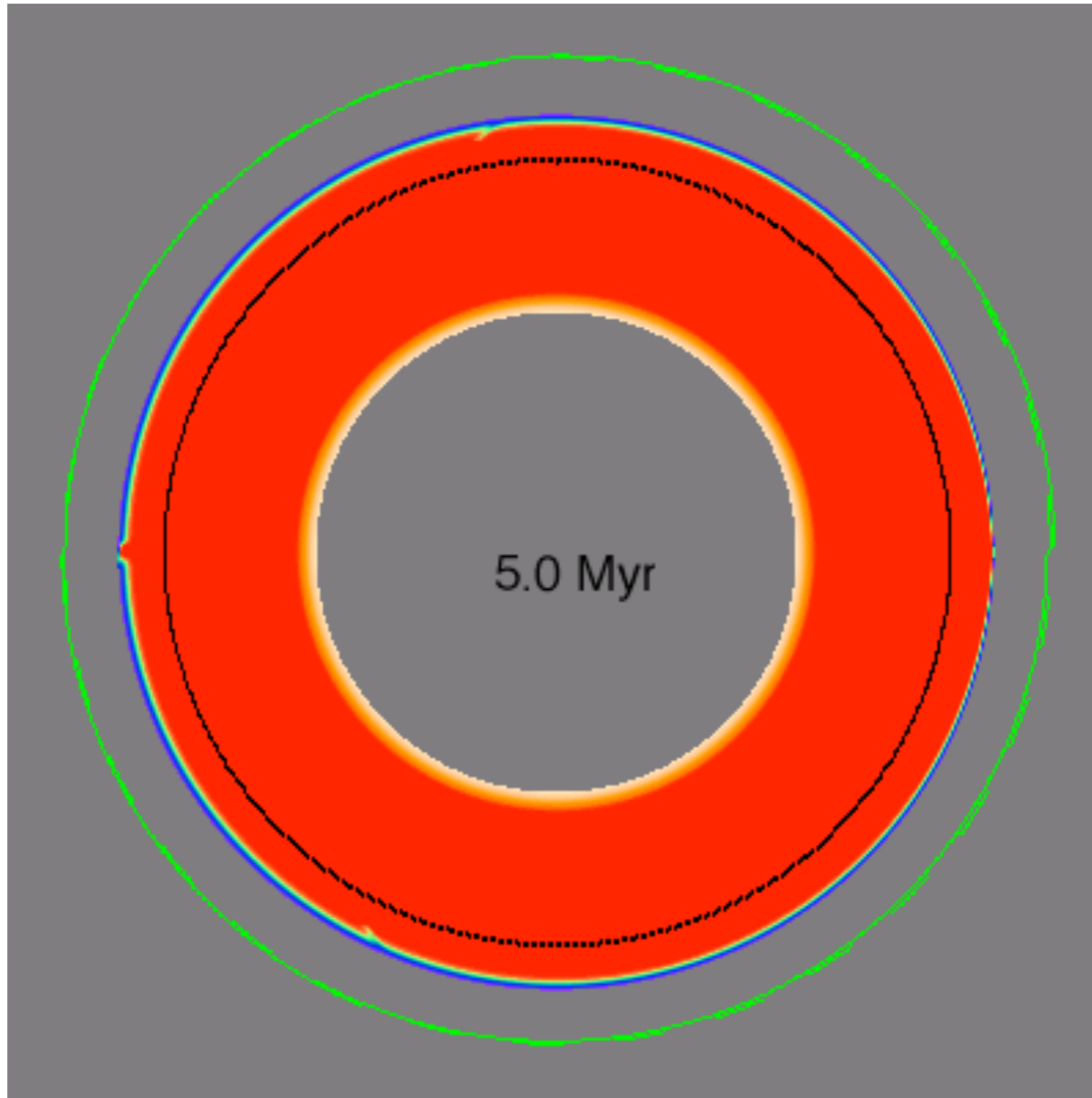

Michael Gurnis, Caltech